

# iNELS

Wireless electro-installation



[elkoop.com/wireless](http://elkoop.com/wireless)





---

**ELKO EP**

---

**ELKO EP have been your partner in the field for 30 years, developing and manufacturing the highest quality electronic devices for electroinstallation as well as smart system for residential and building automation.**

ELKO EP employs more than 350 people across 15 foreign branches and exports its products to more than seventy countries. Company of the Year, Visionary of the Year, Superbrands and Global Exporter of the Year are just some of the awards we have received throughout the years as we consistently strive to move forward in the field of innovation and development.

Millions of relays, thousands of smart homes, hundreds of buildings and many satisfied customers - This is ELKO EP; a traditional company based in the center of Europe, where own development, production, logistics, and service are at the forefront of our focus.

# Facts & stats



**30 %**

Czech

**40 %**

export

**30 %**

branches



## WORLDWIDE

11 branches  
3 franchises  
70 export countries

**350**

employees  
in holding

**30 000 +**

iNELS  
installations

**30 000 000 +**

manufactured  
products

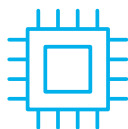

## R&D

continuously  
innovative

## MANUFACTURER

fully automated  
complete proces

## SUPPORT

24 / 7 / 365

**World leader**  
in DIN rail relays production

### UNITS

Individual elements of the iNELS system for personalised installation.

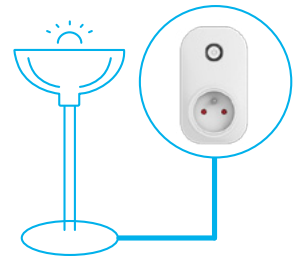
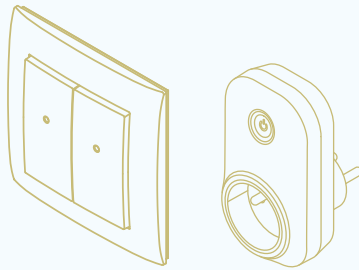

### KITS

Pre-Set elements for everyday applications.

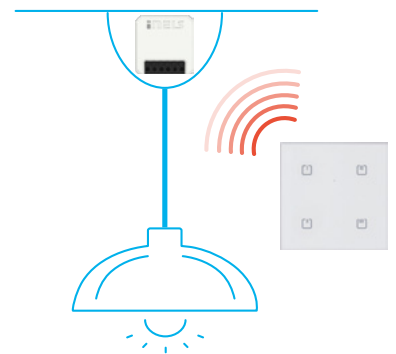
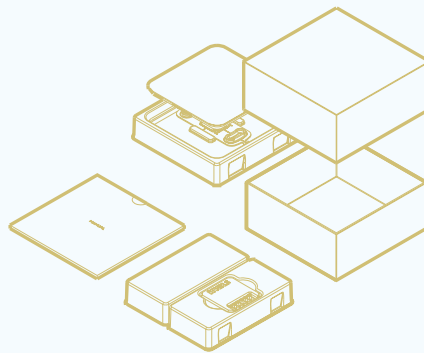
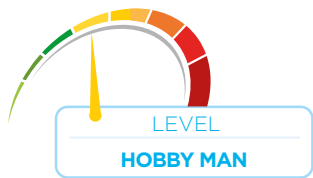

### CONNECTED HOME

A simple solution to turn your house into a smart home, without any structural intervention.

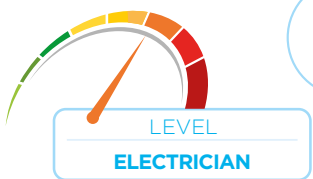

### SMART BUILDING

When using wireless elements is faster and cheaper.

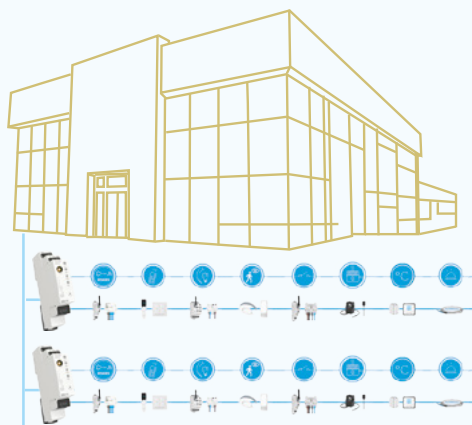
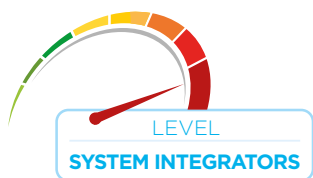



**On wall button controllers**

RFWB-20 / RFWB-40

- 2 or 4 buttons
- simple installation – can be attached or fixed anywhere
- in LOGUS<sup>90</sup> design frames (natural materials and colour combinations)

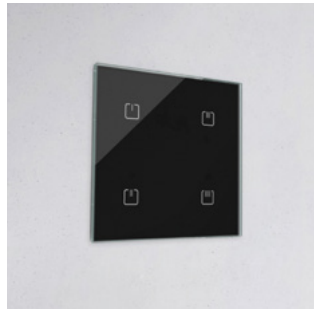

**Glass touch controller**

RFGB-20 / RFGB-40

- wall controller in elegant glass design
- 2 or 4 buttons
- in black or white glass sharp or rounded edges



**Wireless touch unit**

RF Touch-2/BE, RF Touch-2/BR

- wireless touch unit for flushed mount
- it will become a central, wireless intuitively controlled home
- coloured 4" TFT display
- eLAN-RF gateway included



**RF Key**

RF Key-40B/W

- 4 or 6 buttons controller
- pocket controller for every day
- in colour white or black



**Matter compatible**



iNELS Wireless: units overview ..... 8

**Controllers**

RFWB-20/G, RFWB-20/GB, RFWB-40/G, RFWB-40/GB | On-wall button controllers – **PAIRING BUTTON** ..... 14

RFWB-40G/MT | On-wall button controllers, 4 buttons **MATTER** – (LOGUS<sup>90</sup>) ..... 15

RFOWB-20 | Outdoor controller, 2 buttons – (IP65) ..... 16

RFGB-20/W, RFGB-20/B, RFGB-40/W, RFGB-40/B | Glass touch controllers, SHARP – **PAIRING BUTTON** ..... 17

RFGB-40B/MT, RFGB-40W/MT | Glass touch controller – 4 buttons, SHARP **MATTER** ..... 18

RFSW-62, RFSW-262 | Glass touch controller with output relays – **NEW!** ..... 19

RFDW-71, RFDW-271 | Glass touch controller with dimmer – **NEW!** ..... 20

RFGB-220/W, RFGB-220/B, RFGB-240/W, RFGB-240/B | Glass touch controllers, ROUND – **PAIRING BUTTON** ..... 22

RF Pilot/W, RF Pilot/A | Remote RF controller with display ..... 23

RF KEY-40/W, RF KEY-40/B, RF KEY-60/W, RF KEY-60/B | Key fob – **PAIRING BUTTON** ..... 24

**Switches**

RFSA-61B | Switch unit, 1-channel – (BOX) ..... 25

RFSAI-61BPF-SL – **NEW!**, RFSAI-61B-SL, RFSAI-62B-SL, RFSAI-11B-SL | Switch units with the inputs for external buttons – (BOX-SL) ..... 26

RFSAI-62B-SL/MT | Switch unit with inputs for external buttons **MATTER** – (BOX-SL) ..... 27

RFJA-32B-SL | Switch unit for shutters – (BOX-SL) ..... 28

RFSa-61MI, RFSa-61M | Switch unit, 1 channel – (1-MODUL DIN rail) ..... 29

RFSa-66MI, RFSa-66M | Switch unit, 6 channels – (3-MODUL DIN rail) ..... 30

RFUS-61 | Switch unit with increased protection – (IP65) ..... 31

RFSC-61N | Switch socket-plug – (PLUG) ..... 32

**Dimmers**

RFDAC-71B | Analog controller, 0(1)-10V – (BOX) ..... 33

RFDEL-71B-SL | Universal dimmer, 1-channel – (BOX-SL) ..... 34

RFDEL-71B-SL/MT | Universal dimmer **MATTER** ..... 35

RFDALI-32B-SL, RFDALI-04B-SL | DALI controller, for 32/4 addresses – (BOX-SL) – **NEW!** ..... 36

RFDEL-71M | Universal dimmer, 1-channel – (3-MODUL DIN rail) ..... 37

RFDEL-76M | Universal dimmer, 6-channels – (6-MODUL DIN rail) ..... 38

RFDA-73M/RGB | Dimmer for LED (RGB) strips, 3-channels – (3-MODUL DIN rail) ..... 39

RFDSC-71N | Dimming socket-plug – (PLUG) ..... 41

**Temperature control**

RFTC-10/G | System temperature controller – (LOGUS<sup>90</sup>) ..... 42

RFTC-50/G | Autonomous temperature controller – (LOGUS<sup>90</sup>) ..... 43

RFSTI-11B-SL | Switch unit with external temperature sensor – (BOX-SL) ..... 44

RFTI-20 | Temperature and humidity sensor – (SURFACE) ..... 45

RFATV-2 | Wireless thermostatic valve ..... 46

TC, TZ | Temperature sensors ..... 47

**Converters**

RFIM-40B/BP-SL, RFIM-40B/230-SL | Input contacts converter – (BOX-SL) – **PAIRING BUTTON** ..... 48

RFSG-1M | Input contact converter (1-MODUL DIN rail) – **PAIRING BUTTON** ..... 49

RFTM-1 | Pulse converter – (IP65) ..... 50

**Detectors**

RFSF-100 | Flood detector ..... 51

RFSOU-1 | Twilight switch – (IP65) ..... 52

RFWD-100, RFWD-100/MT | Window/door detector **MATTER** – **NEW!** ..... 53

RFMD-100 | Motion detector ..... 54

RFMD-200 | Motion detector for ceiling mounting – **NEW!** ..... 55

RFSLT-S3 | Wireless hydrostatic level sensor – (IP65) – **NEW!** ..... 56

**System units**

RF Touch-2/BE, RF Touch-2/BR | Wireless touch unit – **NEW!** ..... 58  
 eLAN-RF-103 | Smart RF gateway **MQTT** ..... 60  
 RFRP-20N | Repeater to extend the range – (PLUG) ..... 61

**HRESK**

RFGS-30/S | Infront of door hotel room unit – **NEW!** ..... 64  
 RFSW-62/S | Glass touch wireless controller with symbols – **NEW!** ..... 65  
 RFTC-150/G | Temperature controller ..... 66  
 RFS-266M | Switch unit for fancoil control – **NEW!** ..... 67  
 RFSAI-161B | Lighting control unit with pair detectors and external button input – (BOX) ..... 68  
 RFSTI-111B | Overheating/overcooling switch unit with advanced functions – (BOX) ..... 70

**Accessories**

AN-I | Internal antenna ..... 71  
 RFAF/USB | Service Key ..... 71  
 AN-E1 | External antenna ..... 72  
 AN-E3 | External antenna ..... 72  
 MS | Sensors for RFTM-1 ..... 73  
 WS | Sensors for RFTM-1 ..... 73  
 LS | Sensors for RFTM-1 ..... 73

**Overview of functions**

Applications ..... 74  
 Voice assistants ..... 76  
 Protocol and compatibility ..... 77  
 Product loadability ..... 78  
 Pairing controllers with iNELS Wireless devices ..... 80  
 Setting the functions on the controllers ..... 82  
 Installation possibilities ..... 83  
 Product dimension ..... 84  
 Scope Architecture ..... 86

## Controllers

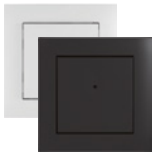

**RFBW-20/G** – white  
**RFBW-20/GB** – black  
 On-wall button controller  
 – 2 buttons

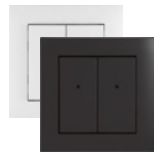

**RFBW-40/G** – white  
**RFBW-40/GB** – black  
 On-wall button controller  
 – 4 buttons

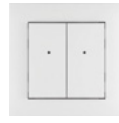

**RFBW-40G/MT**  
 On-wall button controller  
 – 4 buttons



**RFOB-20**  
 Outdoor controller  
 – 2 buttons



**RF KEY-40/W** – white  
**RF KEY-40/B** – black  
 Key fob – 4 buttons



**RF KEY-60/W** – white  
**RF KEY-60/B** – black  
 Key fob – 6 buttons



**RF Pilot/W** – white  
**RF Pilot/A** – anthracite  
 Remote Wireless controller  
 with display



**RFGB-20/W** – white  
**RFGB-20/B** – black  
 Glass touch controller  
 SHARP – 2 buttons

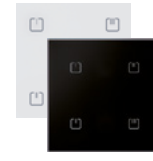

**RFGB-40/W** – white  
**RFGB-40/B** – black  
 Glass touch controller  
 SHARP – 4 buttons



**RFGB-220/W** – white  
**RFGB-220/B** – black  
 Glass touch controller,  
 ROUND – 2 buttons



**RFGB-240/W** – white  
**RFGB-240/B** – black  
 Glass touch controller,  
 ROUND – 4 buttons



**RFSW-62/B** – black glass, SHARP  
**RFSW-262/W** – white glass, ROUND  
 Glass touch controller  
 with output relays



**RFDW-71/B** – black glass, SHARP  
**RFDW-271/W** – white glass, ROUND  
 Glass touch controller  
 with dimmer



**RFGB-40B/MT** – black glass  
**RFSW-40W/MT** – white glass  
 Glass touch controller – 4 buttons,  
 SHARP / MATTER



## Switch units



**RFS-61B**  
 Switch unit, 1 channel  
 – 1× 16 A, multifunction



**RFS-61BPF-SL**  
 Switch unit with inputs for  
 external buttons – 1× 8 A,  
 multifunction, galvanically  
 separated



**RFS-11B-SL**  
 Switch unit with inputs for  
 external buttons – 1× 8 A,  
 singlefunction



**RFS-61B-SL**  
 Switch unit with inputs for  
 external buttons – 1× 8A,  
 multifunction



**RFS-62B-SL**  
 Switch unit with inputs for  
 external buttons 2-channels,  
 2× 8 A (total), multifunction





**RFSAI-62B-SL/MT**  
Switch unit with inputs for external buttons MATTER, 2x 8 A (total)



**RFJA-32B-SL**  
Switch unit for shutters, 2x 8 A



**RFSA-66MI**  
Switch unit, 6 channels with integrated antenna – multifunction, 6x 8 A



**RFSA-61MI**  
Switch unit, 1 channel with integrated antenna – multifunction, 1x 16 A



**RFSA-66M**  
Switch units, 6 channels – multifunction, 6x 8 A



**RFSA-61M**  
Switch unit, 1 channel – multifunction, 1x 16 A



**RFUS-61**  
Switch unit with increased protection, 1x 12 A, multifunction



**RFSC-61N**  
Switching socket-plug, – 1x 16 A, multifunction

Dimmers



**RFDAC-71B**  
Analog controller, 0(1)-10 V – multifunction



**RFDALI-32B-SL**  
**RFDALI-04B-SL**  
DALI controller, for 4/32 DALI addresses



**RFDEL-71B-SL**  
Universal dimmer 1-channel – 1x 300 VA – R, L, C, LED, ESL



**RFDEL-71B-SL/MT**  
Universal dimmer, 1-channel – 1x 300 VA, MATTER



**RFDEL-71M**  
Universal dimmer, 1-channel – 1x 600 VA – R, L, C, LED, ESL



**RFDEL-76M**  
Universal dimmer, 6-channels – 6 x 150 VA



**RFDA-73M/RGB**  
Dimmer for LED (RGB) strips, 3-channels



**RFDSC-71N**  
Dimming socket-plug

Temperature control



**RFTC-10/G**  
System temperature controller



**RFTC-50/G**  
Autonomous temperature controller



**RFSTI-11B-SL**  
Switch unit with external temperature sensor



**TC TZ**  
Temperature sensors



**RFATV-2**  
Wireless thermostatic valve



**RFTI-20**  
Temperature and humidity sensor



## Converters



**RFIM-40B/BP-SL**  
4 input contacts converter  
battery powered



**RFIM-40B/230-SL**  
4 input contacts converter  
AC 230 power supply



**RFSG-1M**  
Input contact converter  
–1x permanent contact



**RFTM-1**  
Puls converter

## Detectors



**RFSF-100**  
Flood detector



**RFSOU-1**  
Twilight switch



**RFWD-100**  
Window/Door  
detector



**RFWD-100/MT**  
Window/Door  
detector MATTER



**RFMD-100**  
Motion detector



**RFSLT-S3**  
Wireless hydrostatic level  
sensor



**RFMD-200**  
Motion detector



## System units



**eLAN-RF-103**  
Smart RF gateway  
with LAN



**RFRP-20N**  
Repeater to extend  
the range



**RF Touch-2/BE**  
**RF Touch-2/BR**  
Wireless touch unit  
– flush mounted

Hotel Retrofit (HRESK)

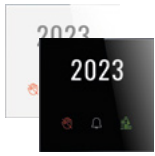

**RFGS-30/SB** – black glass  
**RFGS-30/SW** – white glass  
 Infront of door hotel room unit



**RFSW-62/SB** – black glass  
**RFSW-62/SW** – white glass  
 Wireless touch glass remote control with symbols



**RFTC-150/G**  
 Temperature controller



**RFSA-266M**  
 Switch unit for fancoil control



**RFSAI-161B**  
 Lighting control unit with pair detectors and external button input



**RFSTI-111B**  
 Overheating/overcooling switch unit with advanced functions

Accessories



**RFAF/USB**  
 Service Key



**AN-I**  
 Internal antenna  
 Gain: 2.1 dBi



**AN-E**  
 External antenna  
 Gain: 5 dBi



**AN-E3**  
 External antenna  
 Gain: 3 dBi, IP67



Extension cable for external antenna  
 10 m

Legend:



NEW



PAIRING  
 BUTTON





INCREASED  
 PROTECTION



MATTER



MQTT

-  **RFIO/RFI02** - radiofrequency protocol bidirectional
-  **Wi-Fi**
-  **LAN**

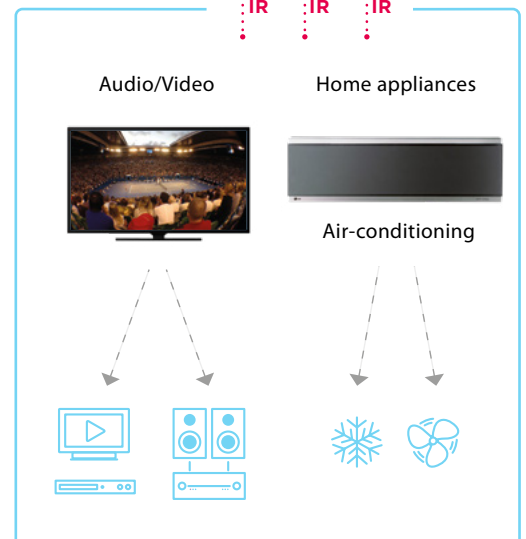
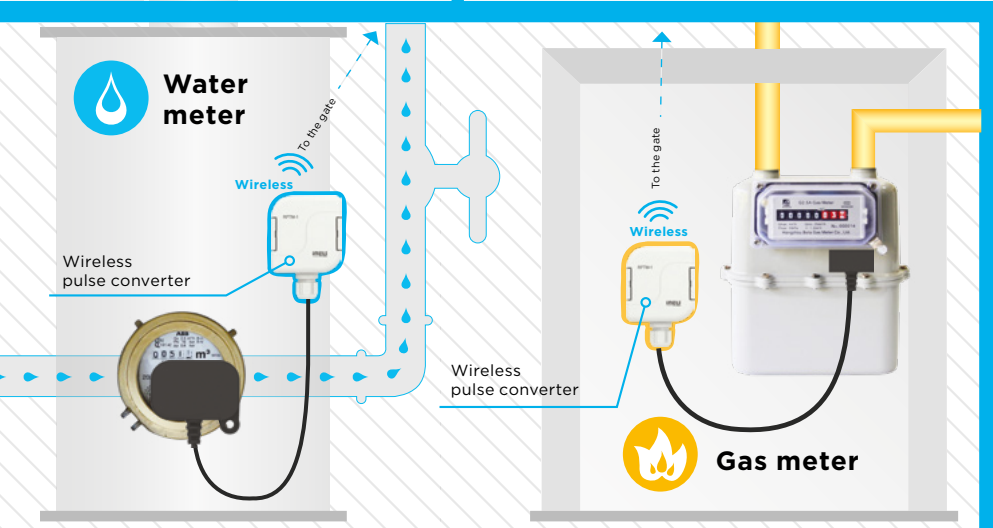
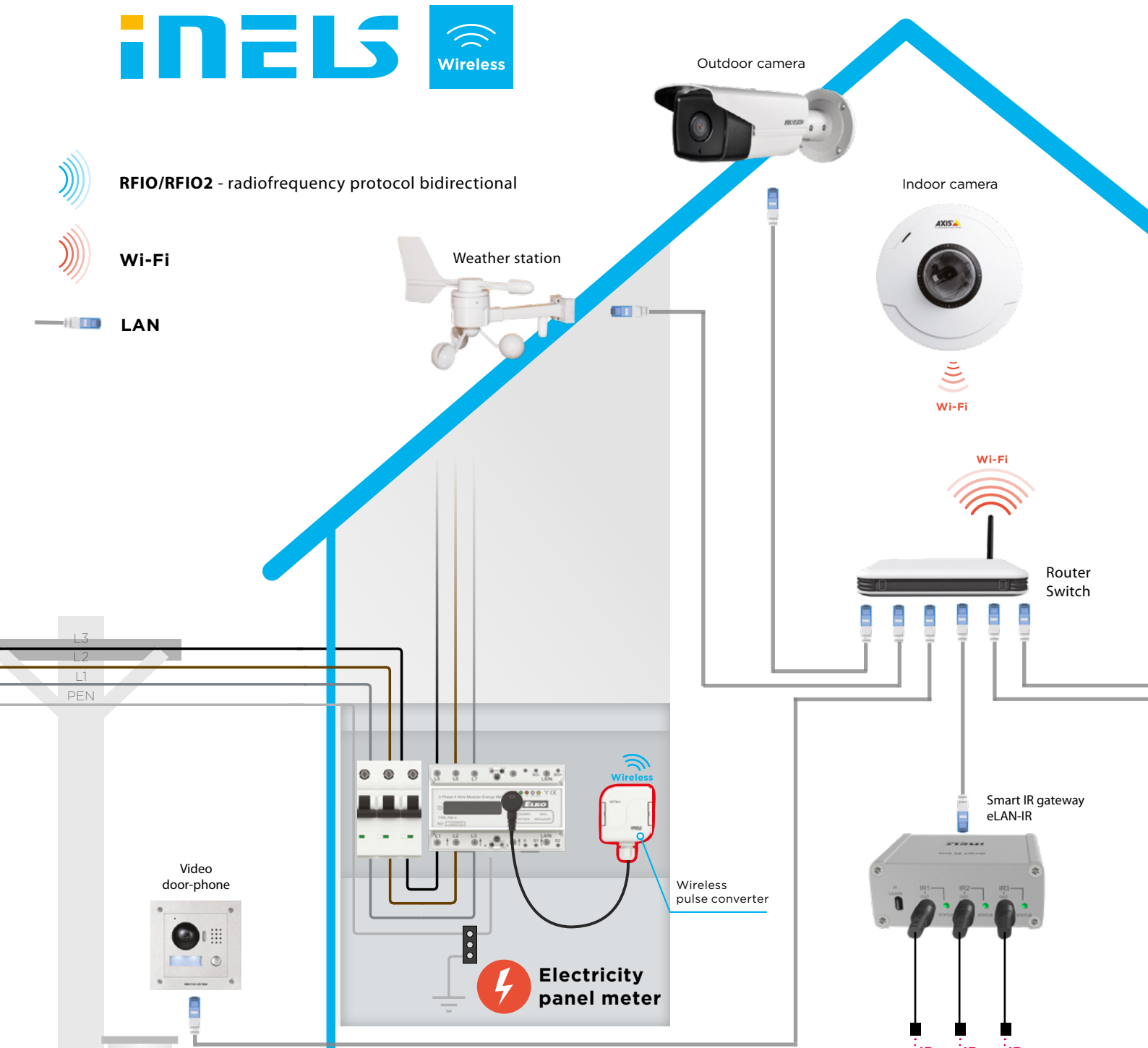

**SW/APP**

**iNELS Cloud** API  
**SAMSUNG** Smart TV  
 amazon alexa Google Home  
 App iNELS.cloud Smart TV application Voice assistants Smart watch

**Controllers:**

Radio & Intercom Touch unit Wall controller Glass controller Thermostat Glass Touch controller with dimmer RF Pilot / Key fob

Smart RF gateway eLAN-RF-103  
**MQTT**

**Detectors:**

RFSLT-S3 Door/window Motion Flood

**Sensors:**

Temperature Twilight

**Units:**

Switch unit - 6 outputs Switch unit to installation box Switching socket Switch unit for shutters Switch unit - 1-channel Dimmer for LED strips

P

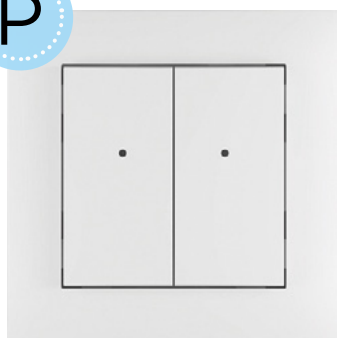

EAN code:

RFWB-20/G: 8595188140379

RFWB-20/GB: 8595188191616

RFWB-40/G: 8595188140607

RFWB-40/GB: 8595188191623

### Technical parameters RFWB-20/G(GB) RFWB-40/G(GB)

Supply voltage:	3 V CR 2032 battery	
Battery life:	around 5 years based on frequency of use	
Transmission indication:	red LED	
Number of buttons:	2	4
Communication protocol:	RFIO	
Frequency:	866–922 MHz (for more information see p. 77)	
Signal transmission method:	unidirectionally addressed message	
Range:	in open space up to 200 m	

### Other data

Operating temperature:	-10 to +50 °C	
Operating position:	any	
Mounting:	glue/screws	
Protection:	IP20	
Contamination degree:	2	
Dimensions frame		
- plastic:	85 x 85 x 16 mm	
- metal, glass, wood, granite:	94 x 94 x 16 mm	
Weight (plastic):*	38 g	39 g
Related standards:	EN 60730, EN 63044, EN 300 220, EN 301 489	

- On-wall button controller is used to control switches and dimmers (lights, gate, garage door, blinds, etc.).
- **RFWB-20/G(GB)**: two buttons enable control of two units independently.
- **RFWB-40/G(GB)**: four buttons enable control of four units independently.
- The flat design with level base makes it ideal for fast installation on any surface (fixation with adhesive or screws in the installation box).
- When pressing the button, it sends a set signal (ON/OFF, dimming, time switching OFF/ON, blinds up/down).
- Sending a command is indicated by a red LED.
- In LOGUS<sup>90</sup> switch frame design (plastic, glass, wood, metal, stone).
- Option of setting light scenes, where with a single press, you can control units of iNELS Wireless.
- Battery power supply (3 V CR 2032 battery - included in the supply) with battery life of around 5 years based on frequency of use.
- Range up to 200 m (in open space), if the signal is insufficient between the controller and unit, use the signal repeater RFRP-20N or protocol component RFIO2 that support this feature.
- RFWB enables communication (RFIO2) and can thus communicate with the CU3-02M.
- Attention: The controller is paired with the elements using the pairing button. Ord. codes for controllers with pairing button: RFWB-20/G Order No.: 8502, RFWB-40/G Order No.: 8489, see Pairing controllers on p. 80.

### Device description

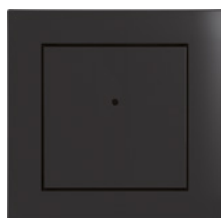
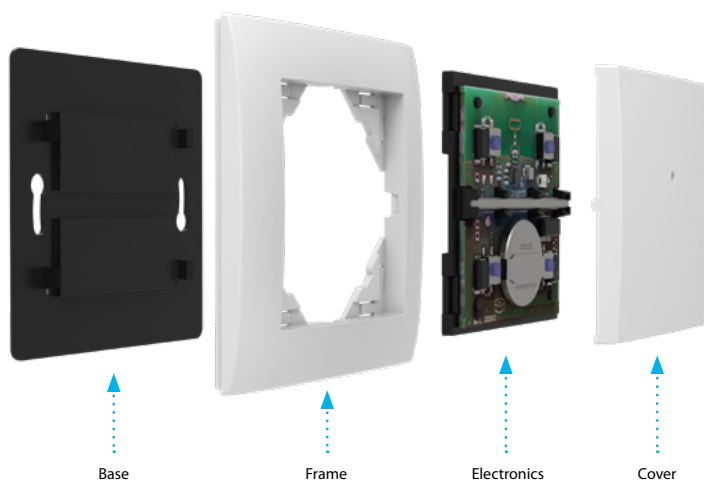
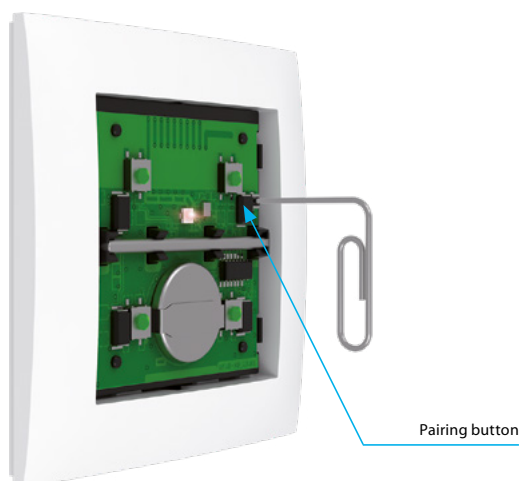
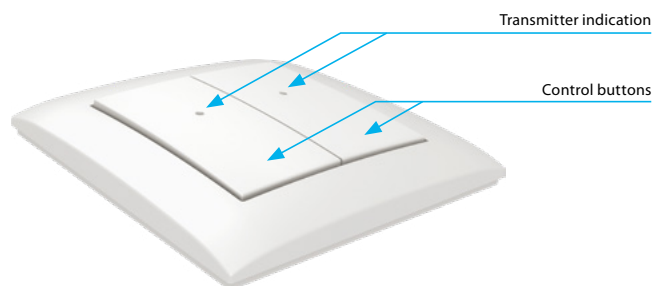

RFWB-20/GB

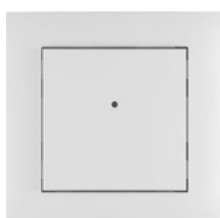

RFWB-20/G



RFWB-40/GB

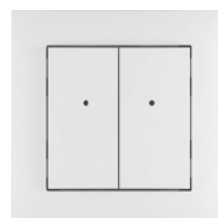

RFWB-40/G

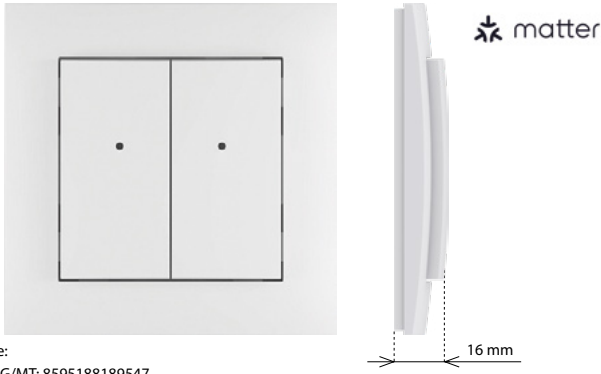

EAN code:  
RFWB-40G/MT: 8595188189547

- The pushbutton type wall-mounted controllers are used to control switches and dimmers (of lights, barriers, gates, window shutters, etc.).
- It communicates on the Thread protocol that guarantees compatibility with other products with the Matter support.
- Its flat design with a flat base predestines it for quick installation on any surface (by sticking or screwing it onto a junction box).
- After a short pressing the pushbutton, it transmits the preset command (short pressing, long pressing).
- Transmission of the command is indicated by a red LED.
- Design of the LOGUS90 switch frames (plastics, glass, wood, metal, stone).
- Battery power supply (3V battery CR 2032 is included) with lifetime of approx. 2 years, depending on the frequency of use.
- The applicable reach is up to 200m (in free area).
- The element with the actuator can be paired through a border router supporting Matter and through an application supporting Matter. The border router is understood as equipment such as HomePod Mini, Google Nest Hub or Samsung SmartThings Station.

Technical parameters	RFWB-40G/MT
Supply voltage:	3V CR 2032 battery
Battery life:	around 2 years based on frequency of use
Transmission indication:	red LED
Number of buttons:	4
Application protocol:	Matter
Communication protocol:	THREAD
Frequency:	2,4 GHz
Signal transmission method:	MESH
Range:	in open space up to 200 m

Other data	
Operating temperature:	-10 to +50 °C
Operating position:	any
Mounting:	glue/screws
Protection:	IP20
Contamination degree:	2
Dimensions frame	
- plastic:	85 x 85 x 16 mm
- metal, glass, wood, granite:	94 x 94 x 16 mm
Weight (plastic):	39 g
Related standards:	EN 60730, EN 63044, EN 300 220, EN 301 489

Device description

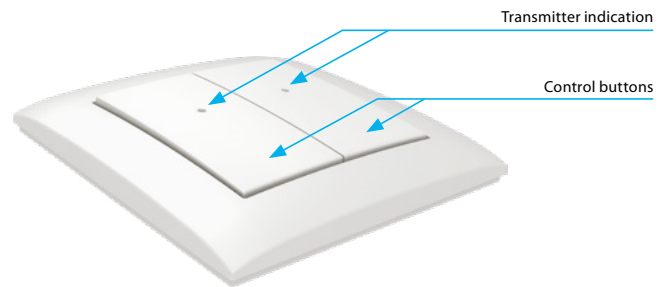

LOGUS<sup>90</sup>

Choose your own style

Flat wireless switches that can be mounted on glass, tile, furniture ... Such a quick change of location when you're moving.





EAN code:  
RFOB-20: 8595188181471

Technical parameters	RFOB-20
Supply voltage:	3 V CR 2032 battery
Battery life:	around 5 years based on frequency of use
Transmission indication:	Integrated red LED
Number of buttons:	2
Communication protocol:	RFIO
Frequency:	866–922 MHz (for more information see p. 77)
Signal transmission method:	unidirectionally addressed message
Range:	in open space up to 200 m
Other data	
Operating temperature:	-10 to +50 °C
Mounting:	screws/double sided tape
Colour design:	white (RAL 9003)
Protection:	IP65
Contamination degree:	2
Dimensions frame:	64 x 74 x 44 mm
Weight:	112 g
Related standards:	EN 60730, EN 63044, EN 300 220, EN 301 489

- The wireless push-button controller with IP65 protection is used to control iNELS Wireless components and protect them from the outdoor environment.
- 2 buttons allow (independently of each other) control of an unlimited number of components (actuators).
- The controller is suitable for control from the pool, garden, terrace, and pergola. It can be used as an uncovered bell button.
- Fastening with screws or double-sided tape.
- Battery power supply (3 V CR 2032 battery - included in the supply) with battery life of around 5 years based on frequency of use.
- Pairing controllers on p. 80

#### Device description

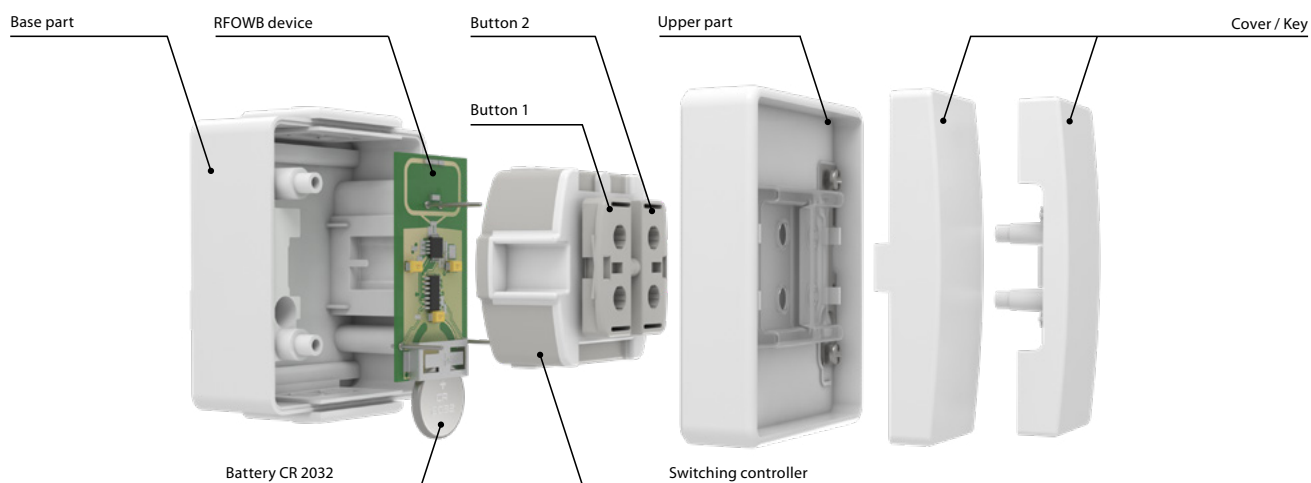
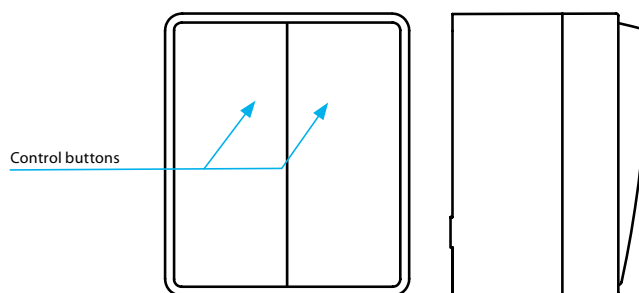



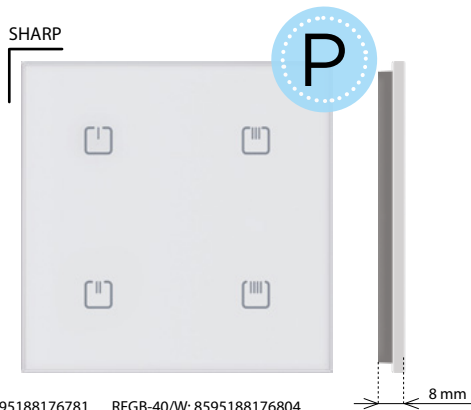

RFGB-20/W: 8595188176781    RFGB-40/W: 8595188176804  
 RFGB-20/B: 8595188176798    RFGB-40/B: 8595188176811

Technical parameters	RFGB-20	RFGB-40
Supply voltage:	2x 3 V CR 2032 batteries	
Battery life:	around 2 years based on frequency of use	
Transmission indication:	red LED	
Number of capacitive buttons:	2	4
Communication protocol:	RFIO	
Frequency:	866–922 MHz (for more information see p. 77)	
Signal transmission method:	unidirectionally addressed message	
Range:	in open space up to 200 m	
<b>Other data</b>		
Operating temperature:	-10 to +50 °C	
Operating position:	any	
Mounting:	glue/screws	
Protection:	IP20	
Contamination degree:	2	
Dimensions:	94 x 94 x 8 mm	
Weight:	107 g	107 g
Related standards:	EN 60730, EN 63044, EN 300 220, EN 301 489	

- The glass touch controller is a design iNELS Wireless unit and is available in elegant black and white variants.
- Only 8 mm thick.
- **RFGB-20:** 2 capacitive buttons allows to control 2 devices.
- **RFGB-40:** 4 capacitive buttons allows to control 4 devices.
- When pressing the button, it sends a set signal (ON/OFF, dimming, time switching OFF/ON, blinds up/down). Sending a command is indicated by a red LED.
- Option of setting light scenes, where with a single press, you can control units of iNELS Wireless.
- The rear base allows to be attached to installation using screws, double-sided tape or keeping controller on the table.
- Battery power supply (2x 3 V CR 2032 batteries - included in the supply) with battery life of around 2 years based on frequency of use.
- Range up to 200 m (in open space), if the signal is insufficient between the controller and unit, use the signal repeater RFRP-20N or protocol component RFIO2 that support this feature.
- Attention: The controller is paired with the elements using the pairing button. Ord. codes for controllers with pairing button: RFGB-20/W Order No.: 8513, RFGB-20/B Order No.: 8512, RFGB-40/W Order No.: 8514, RFGB-40/B Order No.: 8488, see Pairing controllers on p. 80.

**Device description**

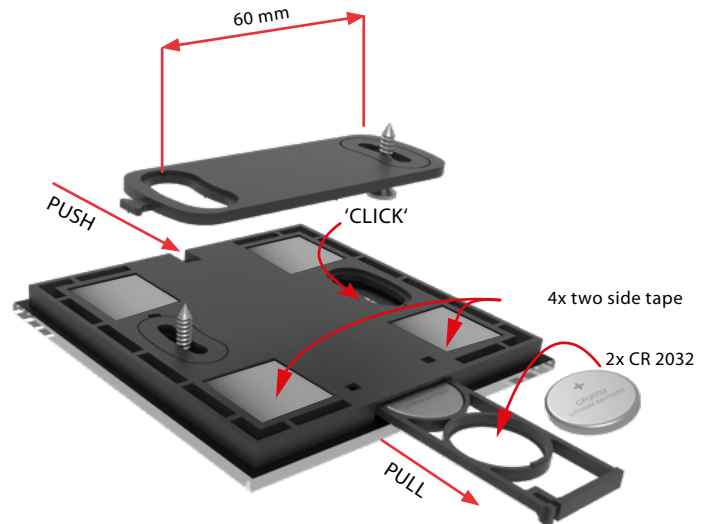
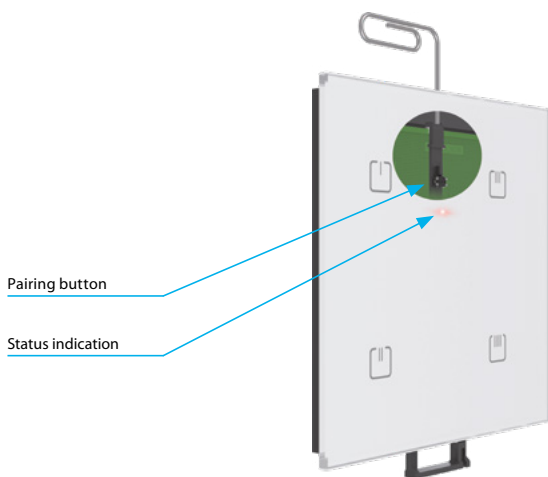
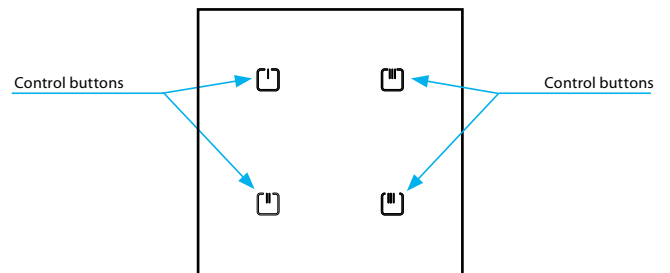

**Variants**



RFGB-20/W

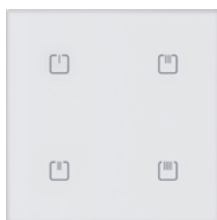

RFGB-40/W



RFGB-20/B

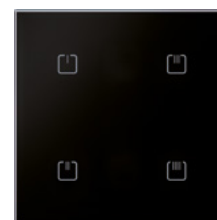

RFGB-40/B

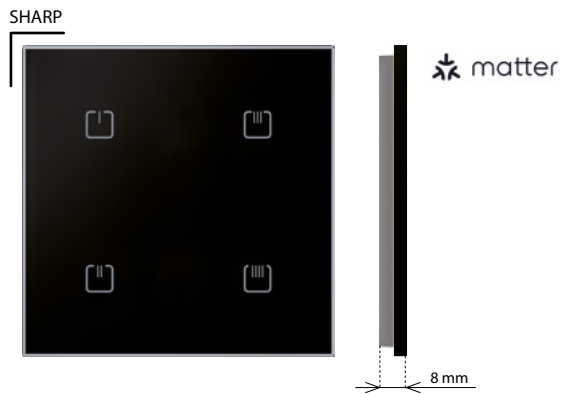

EAN code:  
RFGB-40W/MT: 8595188189773  
RFGB-40B/MT: 8595188189768

Technical parameters	RFGB-40B/MT, RFGB-40W/MT
Supply voltage:	2x 3 V CR 2032 batteries
Battery life:	around 2 years based on frequency of use
Transmission indication:	red LED
Number of capacitive buttons:	4
Application protocol:	Matter
Communication protocol:	THREAD
Frequency:	2.4 GHz
Signal transmission method:	MESH
Range:	in open space up to 200 m
<b>Other data</b>	
Operating temperature:	-10 to +50 °C
Operating position:	any
Mounting:	glue/screws
Protection:	IP20
Contamination degree:	2
Dimensions:	94 x 94 x 8 mm
Weight:	107 g
Related standards:	EN 60669, EN 300 220, EN 301 489 R&TTE Directive,

- Glass touch controller in an elegant black or white glass variant with a width of only 8 mm.
- Communicating on the Thread protocol, which guarantees compatibility with other Matter-enabled products.
- 4 capacitive buttons allow you to control 4 independent devices.
- After pressing the button, it sends the set command (short press, long press). Sending a command is indicated by a red LED.
- The flat mounting base allows installation with screws, double-sided tape or placement on the table.
- Battery power (2x 3 V batteries CR 2032 - part of the package) with a lifespan of approx. 2 years depending on the frequency of use.
- Range up to 200 m (in open space).
- The element with the actuator can be paired through a border router supporting Matter and through an application supporting Matter. The border router is understood as equipment such as HomePod Mini, Google Nest Hub or Samsung SmartThings Station.

### Device description

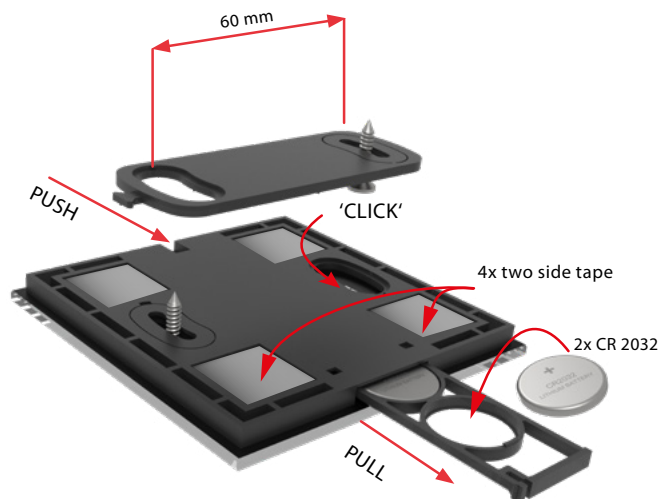
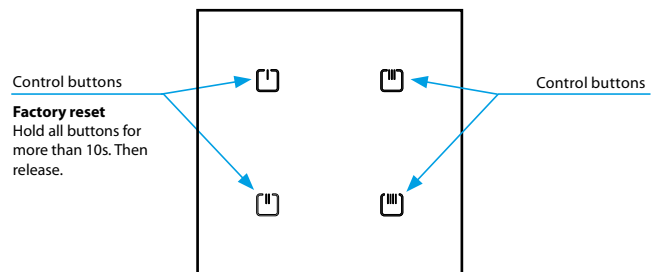

### Variants

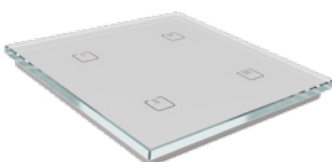

RFGB-40W/MT

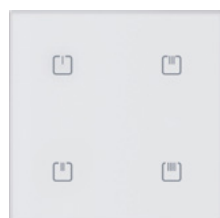

RFGB-40W/MT

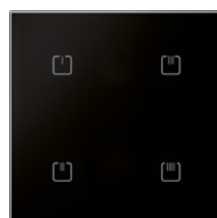

RFGB-40B/MT

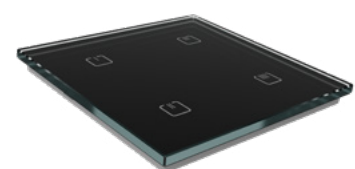

RFGB-40B/MT

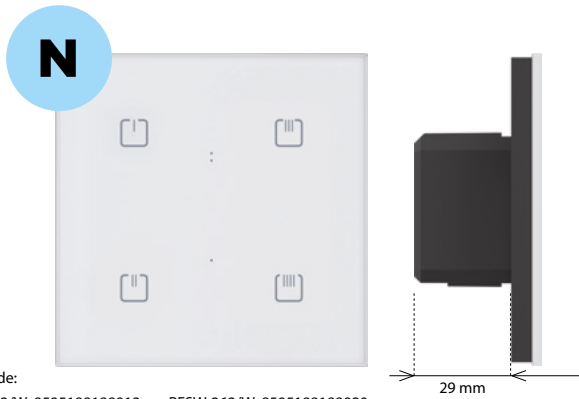

EAN code:  
 RFSW-62/W: 8595188188913    RFSW-262/W: 8595188188920  
 RFSW-62/B: 8595188188708    RFSW-262/B: 8595188188906

Technical parameters		RFSW-62/230V, RFSW-262/230V
Supply voltage:		230 V AC / 50-60 Hz
Apparent power:		1.1 VA
Dissipated power:		0.8 W
Supply voltage tolerance:		±10 %
<b>Output</b>		
Number of contacts:		2 switchingw
Breaking capacity:		8 A / AC1
Current rating:		2000 VA / AC1
Peak current:		10 A / <3 s
Switching voltage:		250 V AC1
Mechanical life:		1x10 <sup>3</sup>
Electrical life (AC1):		1x10 <sup>3</sup>
<b>Control</b>		
Wireless:		up to 25-channels (buttons)
Communication protocol:		RFIO2
Frequency:		866–922 MHz (for more information see p. 77)
Repeater function:		yes
Manual control:		4 touch keys, button PROG
Button backlight:		white LED with intensity change
Indications PROG:		red/green LED
Range:		in open space up to 160 m
<b>Connection</b>		
Terminals:		0.5 - 1 mm <sup>2</sup>
<b>Other data</b>		
Operating temperature:		-10 to +50 °C
Storing temperature:		-30 to +70 °C
Protection degree:		IP20
Overvoltage category:		II.
Pollution degree:		2
Operation position:		any
Installation:		into installation box
Dimensions:		94 x 94 x 41 mm
Weight:		148 g

- The glass design controller with two output relays is used to control appliances and lights.
- The touch buttons on the circuit breaker allow you to directly control the output relay as well as other components of the installation.
- The backlight intensity (white LED) of the buttons is automatically adjusted depending on the ambient lighting.
- They can be combined with detectors, controllers, iNELS Wireless or system components.
- 6 functions – button, impulse relay and time function of delayed start or return with a time setting of 2 s - 60 min. Any function can be assigned to each output relay. Function description can be found on p. 82.
- Possibility to set the memory of the output state during a power failure and subsequent restoration of the power supply.
- Each of the outputs can be controlled by up to 12/12 channels (1 channel represents one button on the controller).
- Range up to 160 m (in open space), if the signal is insufficient between the controller and unit, use the signal repeater RFRP-20N or protocol component RFIO2 that support this feature.
- Communication frequency with bidirectional protocol RFIO2.
- Pairing controllers on p. 80.

Colour variants

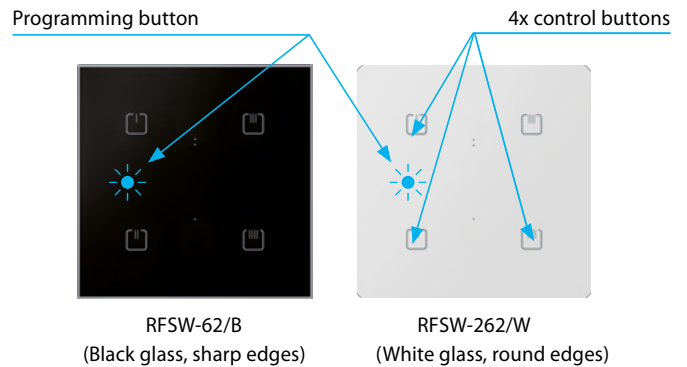

Connection

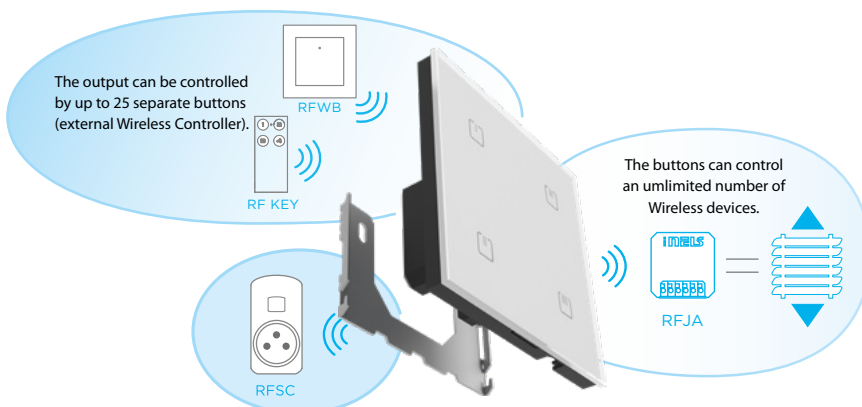
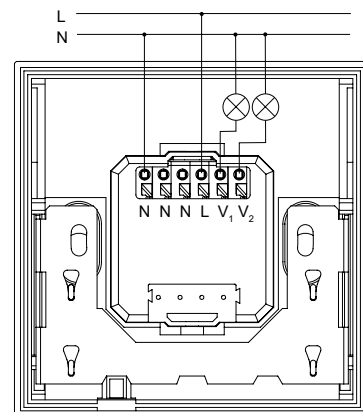

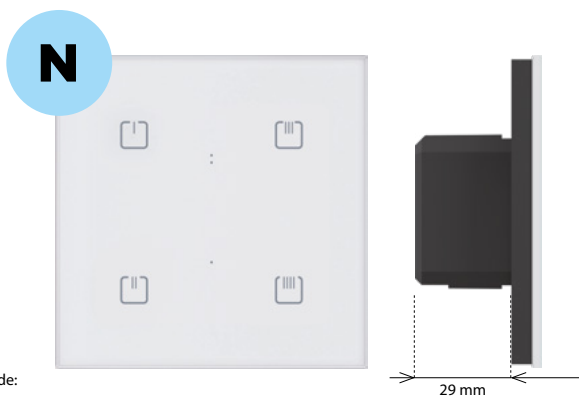

EAN code:

RFDW-71/W: 8595188188944

RFDW-271/W: 8595188188951

RFDW-71/B: 8595188188241

RFDW-271/B: 8595188188937

### Technical parameters RFDW-71/230V, RFDW-271/230V

Supply voltage:	230 V AC / 50-60 Hz
Apparent power:	1.1 VA
Dissipated power:	0.8 W
Supply voltage tolerance:	±10 %
Dimmed load:	R,L,C, LED, ESL

### Output

Contactless:	2 x MOSFET
Load capacity:*	max. 200 W

### Control

Wireless:	up to 25-channels (buttons)
Communication protocol:	RFIO2
Frequency:	866-922 MHz (for more information see p. 77)
Repeater function:	yes
Manual control:	4 touch keys, button PROG
Button backlight:	white LED with intensity change
Indications PROG:	red/green LED
Range:	in open space up to 160 m

### Connection

Max. cable size (mm <sup>2</sup> ):	screwless clamps 0.2 - 1.5 mm <sup>2</sup> solid/flexible
-------------------------------------	--

### Other data

Operating temperature:	-10 to +40 °C
Storing temperature:	-30 to +70 °C
Protection degree:	IP20
Overvoltage category:	II.
Pollution degree:	2
Operation position:	any
Installation:	into installation box
Dimensions:	94 x 94 x 41 mm
Weight:	129 g

\* See page 75 for the load chart for each light source.

The glass design controller with dimmer and touch buttons is used to control light sources:

R – classic lamps (resistive load)

L – halogen lamps with wound transformer (inductive load)

C – halogen lamps with electronic transformer (capacity load)

ESL – dimmable energy-efficient fluorescent lamps

LED – LED light sources (230 V) equipped with LED.

- The touch buttons on the circuit breaker allow you to directly control the integrated dimmer as well as other components of the installation.
- The backlight intensity (white LED) of the buttons is automatically adjusted depending on the ambient lighting.
- They can be combined with detectors, controllers, iNELS Wireless or system components for output control from other locations.
- 7 light functions – smooth increase or decrease with time setting 2 s – 30 min. Function description can be found on p. 82.
- When switched off, the set level is stored in the memory, and when switched back on, it returns to the most recently set value.
- Thanks to setting the min. brightness you will eliminate flashing of the LED and ESL light sources.
- The universal dimmer may be controlled by up to 25-channels.
- Possibility to set the memory status in case of power failure.
- Range up to 160 m (in open space), if the signal is insufficient between the controller and unit, use the signal repeater RFRP-20N or protocol component RFIO2 that support this feature.
- Communication frequency with bidirectional protocol RFIO2.
- Pairing controllers on p. 80.

### Colour variants

Programming button

4x control buttons

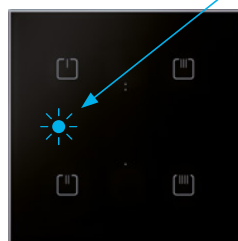

RFDW-71/B  
(Black glass, sharp edges)

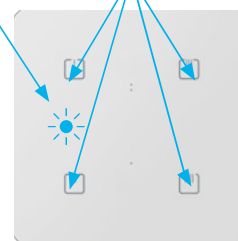

RFDW-271/W  
(White glass, round edges)

### Connection

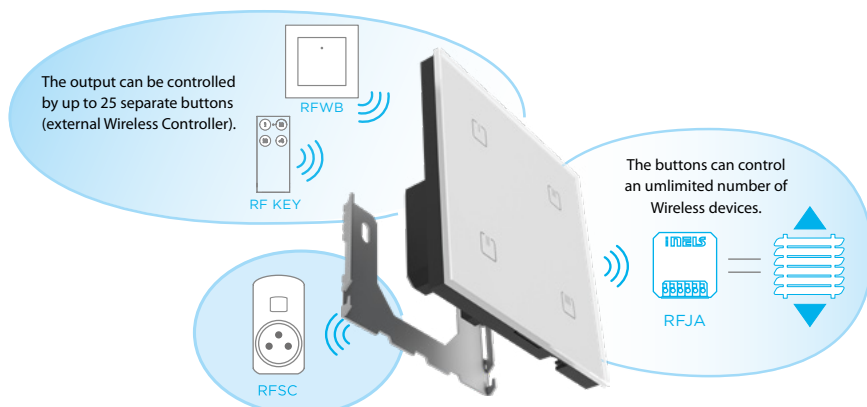
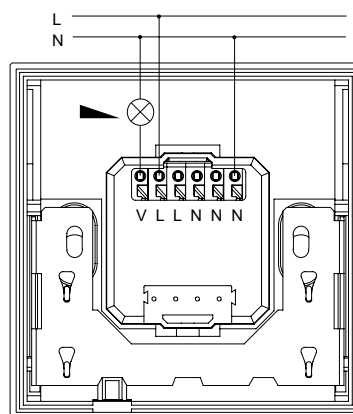

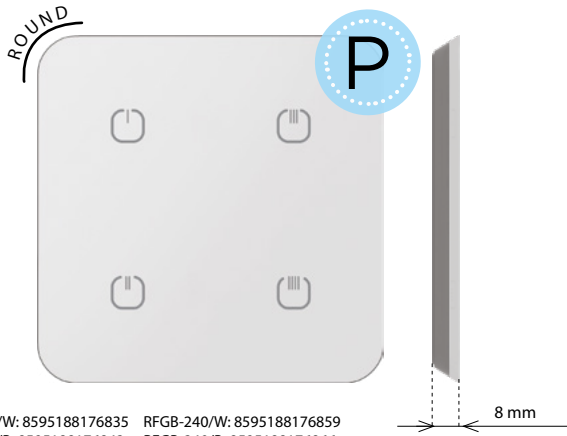

EAN code:  
 RFGB-220/W: 8595188176835 RFGB-240/W: 8595188176859  
 RFGB-220/B: 8595188176842 RFGB-240/B: 8595188176866

Technical parameters	RFGB-220	RFGB-240
Supply voltage:	2x 3 V CR 2032 batteries	
Battery life:	around 2 years based on frequency of use	
Transmission indication:	red LED	
Number of capacitive buttons:	2	4
Communication protocol:	RFIO	
Frequency:	866–922 MHz (for more information see p. 77)	
Signal transmission method:	unidirectionally addressed message	
Range:	in open space up to 200 m	
<b>Other data</b>		
Operating temperature:	-10 to +50 °C	
Operating position:	any	
Mounting:	glue/screws	
Protection:	IP20	
Contamination degree:	2	
Dimensions:	100 x 100 x 8 mm	
Weight:	108 g	108 g
Related standards:	EN 60730, EN 63044, EN 300 220, EN 301 489	

- The glass touch controller is a design iNELS Wireless unit and is available in elegant black and white variants.
- Only 8 mm thick.
- **RFGB-220:** 2 capacitive buttons allows to control 2 devices.
- **RFGB-240:** 4 capacitive buttons allows to control 4 devices.
- When pressing the button, it sends a set signal (ON/OFF, dimming, time switching OFF/ON, blinds up/down). Sending a command is indicated by a red LED.
- Option of setting light scenes, where with a single press, you can control units of iNELS Wireless.
- The rear base allows to be attached to installation using screws, double-sided tape or keeping controller on the table.
- Battery power supply (2x 3 V CR 2032 batteries - included in the supply) with battery life of around 2 years based on frequency of use.
- Range up to 200 m (in open space), if the signal is insufficient between the controller and unit, use the signal repeater RFRP-20N or protocol component RFIO2 that support this feature.
- Attention: The controller is paired with the elements using the pairing button. Ord. codes for controllers with pairing button: RFGB-220/W Order No.: 8517, RFGB-220/B Order No.: 8518, RFGB-240/W Order No.: 8515, RFGB-240/B Order No.: 8516, see Pairing controllers on p. 80.

**Device description**

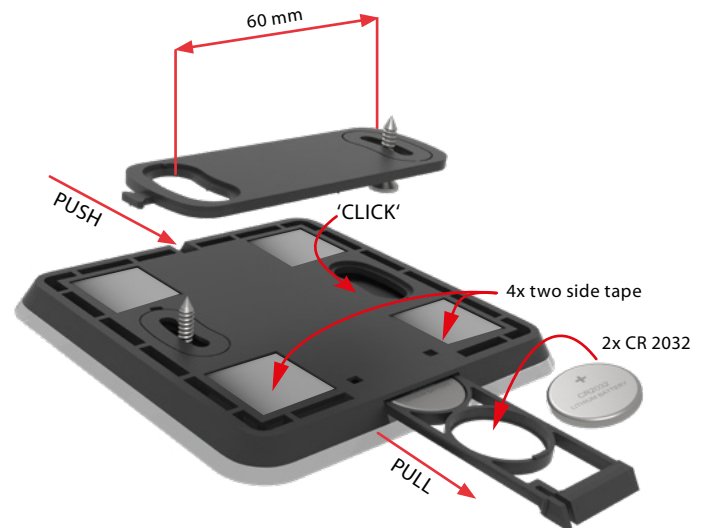
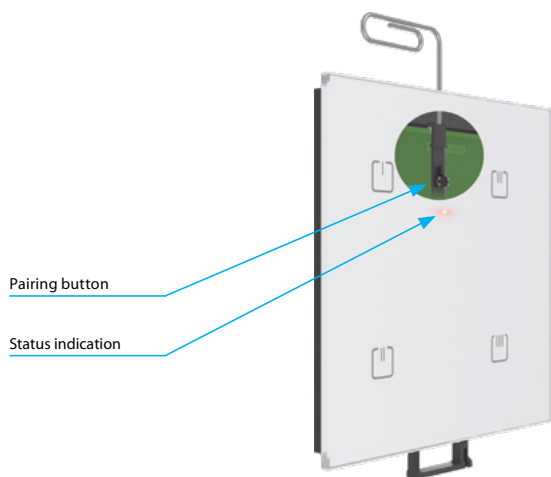
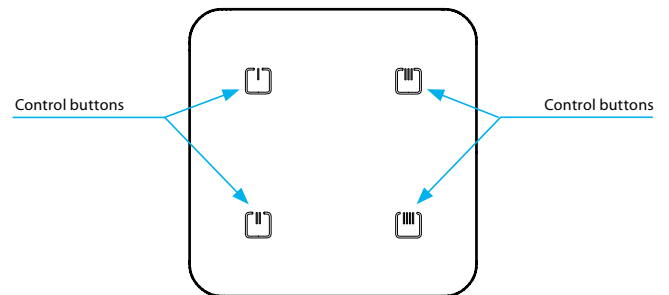

**Variants**



RFGB-220/W

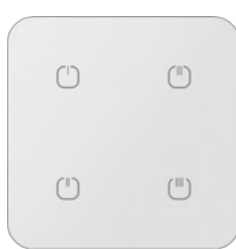

RFGB-240/W



RFGB-220/B



RFGB-240/B



Technical parameters	RF Pilot/W	RF Pilot/A
<b>Display</b>		
Type:	colour OLED	
Resolution:	128 x 128 pixels	
Side ratio:	1:1	
Visible surface:	26 x 26 mm	
Backlighting:	self-illuminating text	
Diagonal:	1.5"	
Control:	direction button, control buttons	
<b>Power supply</b>		
Power supply:	2 x 1.5 V AAA batteries/R03	
Battery life:	approx. 3 years, according to the frequency of use and battery type	
<b>Control</b>		
Range:	in open space up to 200 m	
Communication protocol:	RFIO	
Frequency:	866–922 MHz (for more information see p. 77)	
<b>Other data</b>		
Operating temperature:	0 to +55 °C	
Storage temperature:	-20 to +70 °C	
Colour design:	white	anthracite
Protection:	IP20	
Operating position:	any	
Dimensions:	130 x 41 x 18 mm	
Weight:	61 g	
Related standards:	EN 60730, EN 63044, EN 300 220, EN 301 489	

## RF Pilot



- The Remote Wireless controller with display is a central controller for switching electrical appliances and equipment, dimming lights, controlling blinds, etc.
- Designed in white and anthracite with colour OLED display.
- 4 directional joystick + 2 buttons for intuitive operation.
- Option of setting light scenes, where with a single press, you can control up to 40 units at once.
- Display of room temperature, battery status, date and time directly on display.
- The Favorites mode lets you preset the most frequently used devices on the home screen.
- Bidirectional communication, transmits and receives commands and displays the status of units.
- Thanks to the function of measuring the signal between the controller and unit, you can use it for testing the range and signal quality.
- Battery power (2x 1.5 V AAA batteries - included in supply) with battery life of around 3 years based on frequency of use and type of batteries.
- Range up to 200 m (in open space), if the signal is insufficient between the controller and unit, use the signal repeater RFRP-20N or protocol component RFIO2 that support this feature.

## Device description

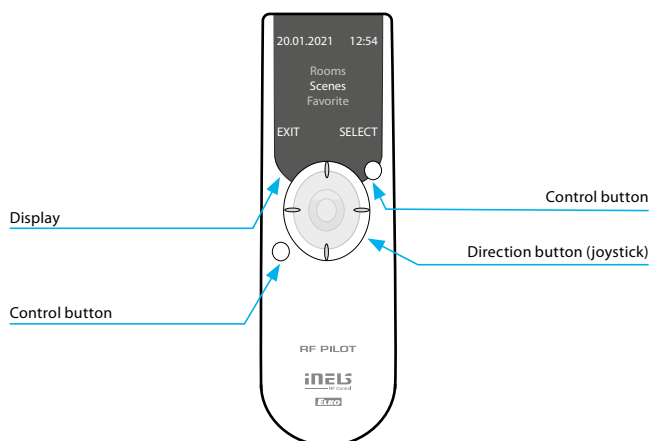

## Display description

## Colour LED display

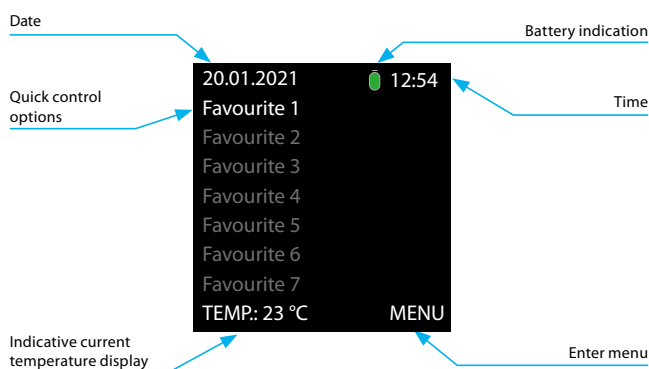

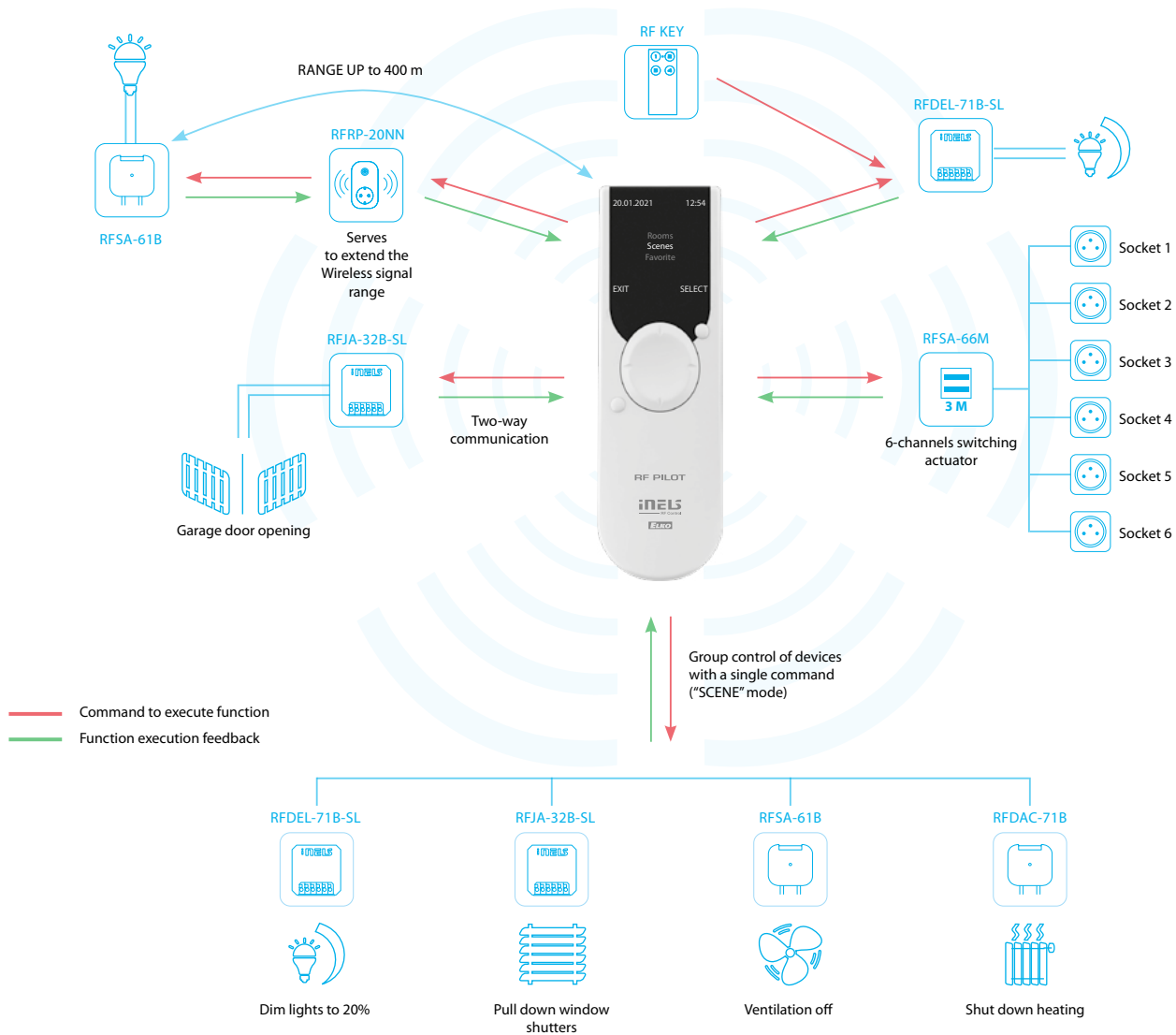

## SCENES

- serves to control actuators as a group with a single touch
- possibility to set up scenes; on activation, for example, window shutters are pulled down and the light will adjust to the required brightness

## WINDOW SHUTTERS

- controlling window shutters, blinds, garage door, etc.
- window shutters are controlled separately or as a group
- the window shutter receivers are powered by either 230 V or 24 V DC (shutters between windows)

## FAVOURITE

- serves to select the most frequently used devices
- on display activation, the "Favourite" menu pops up automatically to provide you with a quick access to controlling devices

## SWITCHING

- this function serves to switch on/off lights, sockets, electrical appliances and devices
- intuitive control thanks to customized name options
- switching actuator function selections: switch on/off, impulse relay, button, delayed ON/OFF (time of delay from 2 seconds to 60 minutes)
- function description can be found on p. 82

## DIMMING

- the regulation of light intensity (light bulbs, LED strips, halogen lights with electrical or coil transformer, fluorescent tubes with dimmable ballast 1–10 V)
- customizable names of individual dimmed circuits (such as "lights" or "living room")
- "sunrise/sunset" imitation - light gradually goes on or off during the preset period between 2 seconds and 30 minutes
- function description can be found on p. 82



EAN code:  
 RF KEY-40/W: 8595188180740    RF KEY-60/W: 8595188180764  
 RF KEY-40/B: 8595188180757    RF KEY-60/B: 8595188180771

Technical parameters	RF KEY-40	RF KEY-60
Supply voltage:	3 V CR 2032 battery	
Battery life:	around 5 years based on frequency of use	
Transmission indication:	red LED	
Number of buttons:	4	6
Communication protocol:	RFIO	
Transmitter frequency:	866–922 MHz (for more information see p. 77)	
Signal transmission method:	unidirectionally addressed message	
Range:	in open space up to 200 m	
Other data		
Operating temperature:	-10 to +50 °C	
Operating position:	any	
Colour design:	white, black	
Protection:	IP20	
Contamination degree:	2	
Dimensions:	64 x 25 x 10 mm	
Weight:	16 g	
Related standards:	EN 60730, EN 63044, EN 300 220, EN 301 489	

- Key fob – sized remote control, available in black and white.
- When pressing the button, it sends a set signal (ON/OFF, dimming, time switching OFF/ON, blinds up/down).
- **RF KEY-40:** four buttons enable control of four units independently.
- **RF KEY-60:** six buttons enable control of four units independently.
- Battery power supply (3 V CR 2032 battery - included in the supply) with battery life of around 5 years based on frequency of use.
- Attention: The controller is paired with the elements using the pairing button. Ord. codes for controllers with pairing button: RF KEY-40/W Order No.: 8504, RF KEY-40/B Order No.: 8503, RF KEY-60/W Order No.: 8505, RF KEY-60/B Order No.: 8490, see Pairing controllers on p. 80.

Device description

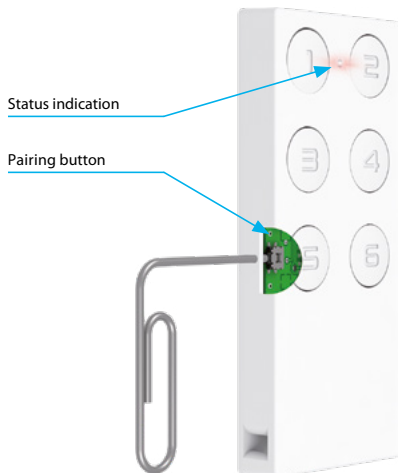
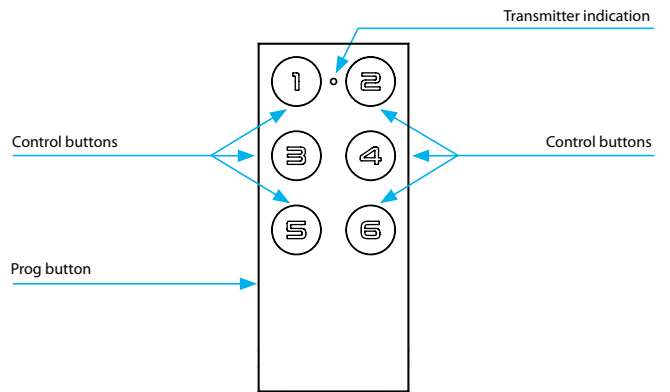

Variants

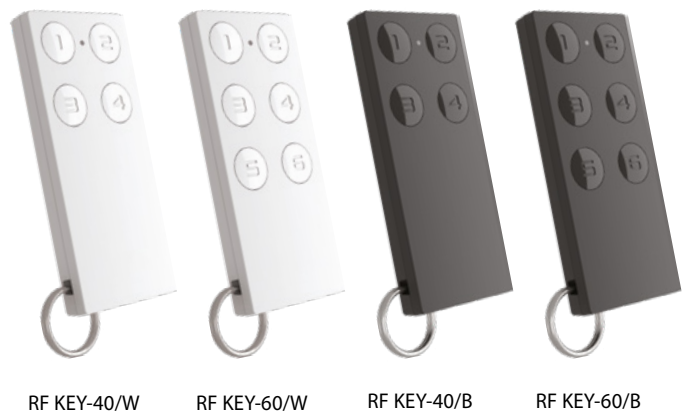





EAN code:  
RFSA-61B: 8595188136242

Technical parameters	RFSA-61B/230V
Supply voltage:	230 V AC
Supply voltage frequency:	50–60 Hz
Apparent input:	7 VA/cos φ= 0.1
Dissipated power:	0.7 W
Supply voltage tolerance:	+10 %; -15 %
<b>Output</b>	
Number of contacts:	1x NO, non potencial
Rated current:	16 A/AC1
Switching power:	4000 VA/AC1, 384 W/DC
Peak current:	30 A/<3 s
Switching voltage:	250 V AC1/24 V DC
Max. DC switching power:	500 mW
Mechanical service life:	3x 10 <sup>7</sup>
Electrical service life (AC1):	0.7x 10 <sup>5</sup>
<b>Control</b>	
Wireless:	up to 25-channels (buttons)
Communication protocol:	RFIO2
Frequency:	866–922 MHz (for more information see p. 77)
Repeater function:	yes
Manual control:	button PROG (ON/OFF)
Range:	in open space up to 200 m
<b>Other data</b>	
Operating temperature:	-15 to +50 °C
Operating position:	any
Mounting:	free at lead-in wires
Protection:	IP30
Overvoltage category:	III.
Contamination degree:	2
Terminals (CY wire, cross-section):	2x 0.75 mm <sup>2</sup> , 2x 2.5 mm <sup>2</sup>
Length of terminals:	90 mm
Dimensions:	49 x 49 x 21 mm
Weight:	46 g
Related standards:	EN 60730, EN 63044, EN 300 220, EN 301 489

- The switching unit with 1 output channel 16 A is used to control appliances, lights (easy to integrate it to control garage doors or gates).
- They can be combined with detectors, controllers, iNELS Wireless or system components.
- **RFSA-61B:** multifunction design – button, impulse relay and time function of delayed ON or OFF with time setting of 2 s – 60 min. Function description can be found on p. 82.
- The switching unit may be controlled by up to 25-channels.
- The programming button on the unit is also used for manual control of the output.
- Memory status can be pre-set in the event of a power failure.
- Range up to 200 m (in open space), if the signal is insufficient between the controller and unit, use the signal repeater RFRP-20N or protocol component RFIO2 that support this feature.
- The BOX design lets you mount it right in an installation box, a ceiling or controlled appliance cover.

Device description

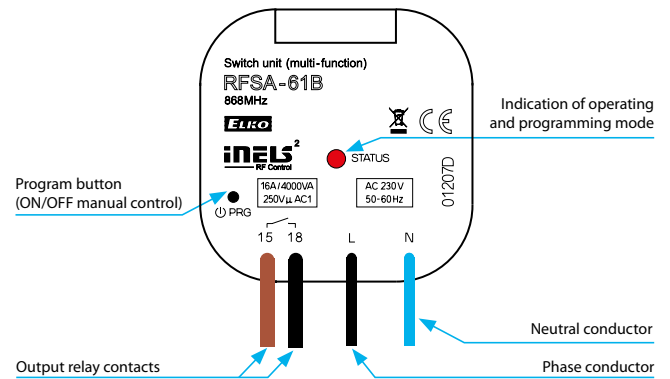

Connection

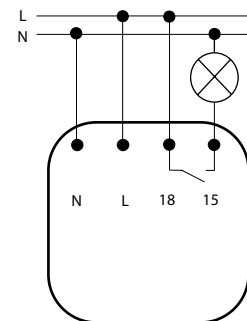

N

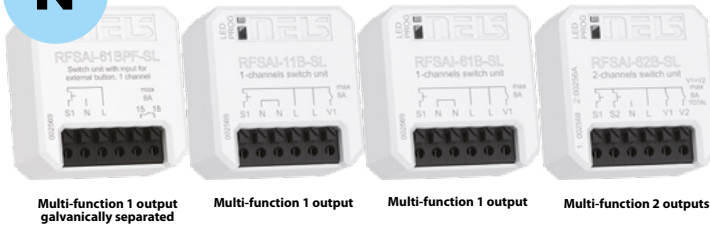

EAN code:  
 RFSAI-61BPF-SL: 8595188189101  
 RFSAI-11B-SL: 8595188183758  
 RFSAI-61B-SL: 8595188182041  
 RFSAI-62B-SL: 8595188182010

Technical parameters	RFSAI-61BPF-SL	RFSAI-11B-SL	RFSAI-61B-SL	RFSAI-62B-SL
Supply voltage:	230 V AC			
Supply voltage frequency:	50-60 Hz			
Apparent input:	7 VA / $\cos \varphi = 0.1$			
Dissipated power:	0.7 W			
Supply voltage tolerance:	+10 %; -15 %			
<b>Output</b>				
Number of contacts:	1x switching		2x switching	
Rated current:	8 A / AC1			
Switching power:	2000 VA / AC1			
Peak current:	I <sub>peak</sub> < 110A 300us / max. input capacity 125 uF			
Switching voltage:	250 V AC1			
Mechanical service life:	1x10 <sup>7</sup>			
Electrical service life (AC1):	1x10 <sup>5</sup>			
<b>Control</b>				
Wireless:	25-channels		2x 12-channels	
Number of functions:	6	1	6	6
Communication protocol:	RFIO2			
Frequency:	866-922 MHz (for more information see p. 77)			
Repeater function:	yes			
Manual control:	button PROG (ON/OFF)			
External button / switch:	yes			
Range:	in open space up to 200 m			
<b>Other data</b>				
Operating temperature:	-15 to +50 °C			
Operating position:	any			
Mounting:	free at lead-in wires			
Protection:	IP40			
Overvoltage category:	III.			
Contamination degree:	2			
Connection:	screwless terminals			
Connecting conductor:	0.2-1.5 mm <sup>2</sup> solid/flexible			
Dimensions:	43 x 44 x 22 mm			
Weight:	31g	45g		
Related standards:	EN 60730, EN 63044, EN 300 220, EN 301 489			

### Function description

1. Button, impulse relay and time functions of delayed start or return with time setting 2 s-60 min. Any function can be assigned to each output relay.
2. The programming button on the element also serves as a manual input control.

- The switching component with one/two output relays is used to control appliances and lights. Switches/buttons connected to the wiring can be used for control.
- They can be combined with Detectors, Controllers or iNELS Wireless System Components.
- The BOX-SL version offers installation directly in the installation box, ceiling or cover of the controlled appliance. Easy installation thanks to screwless terminals.
- It allows the connection of switched loads with a total sum of 8 A (2,000 W).
- Functions: for RFSAI 61B-SL and RFSAI 62B-SL - pushbutton, impulse relay and time functions of delayed start or return with time setting 2 s-60 min. Any function can be assigned to each output relay. For RFSAI-11B-SL, the button has a fixed function - ON / OFF. Function description can be found on p. 82.
- The external button is assigned in the same way as the wireless one.
- Each of the outputs can be controlled by up to 12/12 channels (1-channel represents one button on the controller). Up to 25 channels for RFSAI-61B-SL and RFSAI-11B-SL.
- The programming button on the component also serves as a manual output control.
- Possibility to set the output status memory in case of failure and subsequent power recovery.
- The elements of the repeater can be set for the components via the RFAF / USB service device, PC, application.
- Range up to 200 m (outdoors), in case of insufficient signal between the controller and the device, use the RFRP-20N signal repeater or component with the RFIO2 protocol that support this function.
- Communication with bidirectional RFIO2 protocol.
- The contact material of the AgSnO<sub>2</sub> relay enables switching of light ballasts.

### Device description

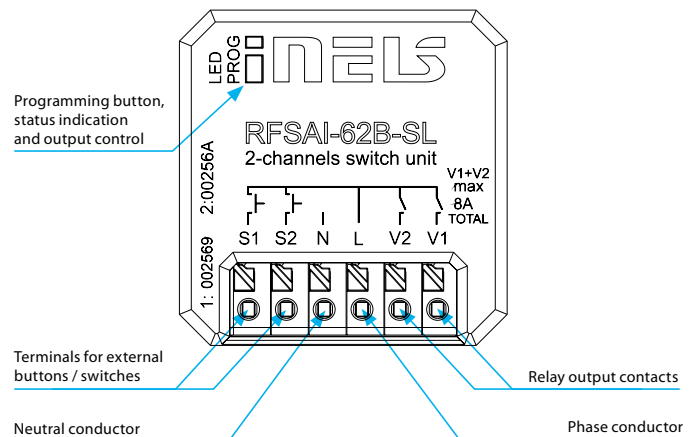

### Connection

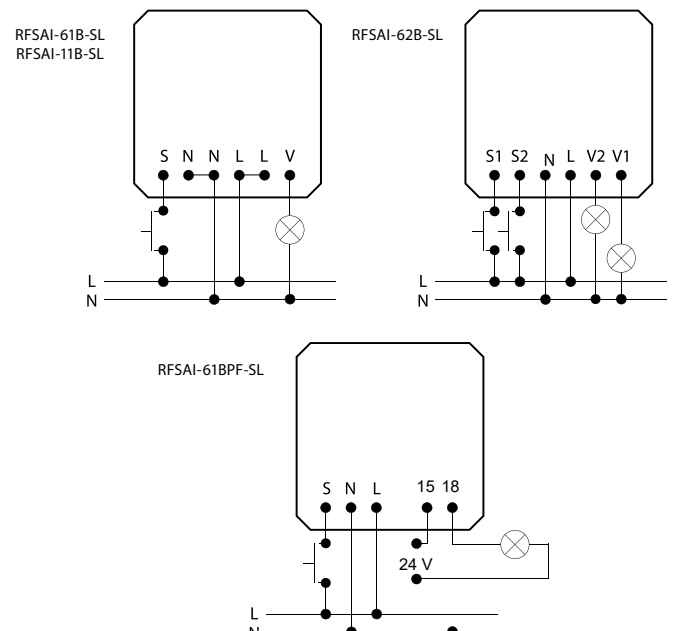



- The switching element with two output relays can be used to control some appliances and lights.
- The Thread protocol guarantees compatibility with other products with the Matter support.
- The wireless controllers (RFGB-40-MT) and also the existing wired switches/pushbuttons can be used for control.
- The BOX-SL design offers installation directly in the junction box, soffit or cover of the controlled appliance. Easy connection of wires thanks to the screw-free terminals.
- The applicable reach is up to 200m (in free area).
- The maximum switched power is 2000W (8A), the relay contact material AgSnO<sub>2</sub> + Zero Cross predestines it for switching of lighting loads.
- The reset pushbutton on the element can also be used as manual control of the input.
- The element with the controller can be paired through a border router supporting Matter and through an application supporting Matter. The border router is understood as equipment such as HomePod Mini, Google Nest Hub or Samsung SmartThings Station.

EAN code:  
RFSAI-62B-SL/MT: 8595188189755

Technical parameters	RFSAI-62B-SL/MT
Supply voltage:	230 V AC
Supply voltage frequency:	50-60 Hz
Apparent input:	7 VA / $\cos \varphi = 0.1$
Dissipated power:	0.7 W
Supply voltage tolerance:	+10%; -15 %
<b>Output</b>	
Number of contacts:	2x switching
Rated current:	8 A / AC1 (in total)
Switching power:	2000 VA / AC1
Peak current:	10 A / <3 s
Switching voltage:	250 V AC1
Mechanical service life:	10 mill.
Electrical service life (AC1):	100 thousand
<b>Control</b>	
Application protocol:	Matter
Communication protocol:	THREAD
Method of signal transmission	MENH
Frequency:	2.4 GHz
Manual control:	button PROG (ON/OFF)
External button / switch:	yes, opposite the L terminal
Range:	in open space up to 200 m
<b>Other data</b>	
Operating temperature:	-15 to + 50 °C
Operating position:	any
Mounting:	free at lead-in wires
Protection:	IP40
Overvoltage category:	III.
Contamination degree:	2
Connection:	screwless terminals
Connecting conductor:	0.2-1.5 mm <sup>2</sup> solid/fi exible
Dimensions:	43 x 44 x 22 mm
Weight:	45 g
Related standards:	EN 60730, EN 63044, EN 300 220, EN 301 489

Device description

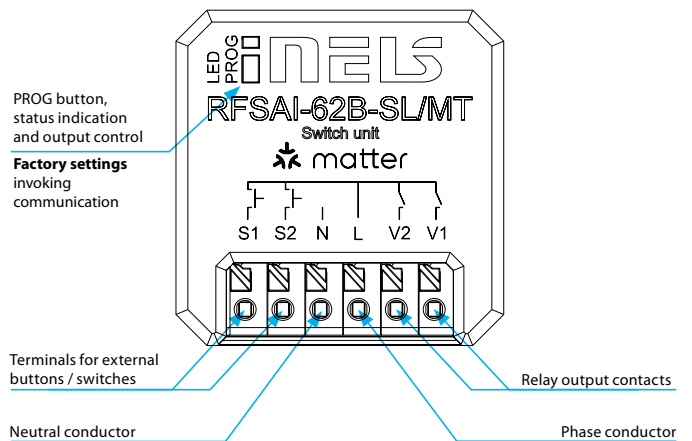

Connection

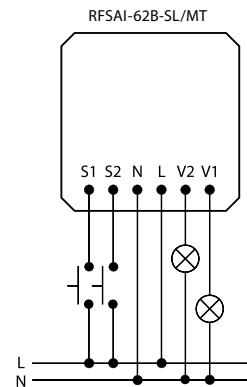



EAN code:  
RFJA-32B-SL: 8595188182546

Technical parameters	RFSAI-32B-SL
Supply voltage:	230 V AC
Supply voltage frequency:	50-60 Hz
Apparent input:	7 VA / $\cos \varphi = 0.1$
Dissipated power:	0.7 W
Supply voltage tolerance:	+10 %; -15 %
<b>Output</b>	
Number of contacts:	2x switching
Rated current:	8 A / AC1
Switching power:	2000 VA / AC1
Peak current:	10 A / <3 s
Switching voltage:	250 V AC1
Mechanical service life:	$1 \times 10^7$
Electrical service life (AC1):	$1 \times 10^5$
<b>Control</b>	
Wireless:	25-channels
Communication protocol:	RFIO2
Frequency:	866-922 MHz (for more information see p. 77)
Repeater function:	yes
Manual control:	PROG (ON/OFF) button
External button / switch:	max. 100 m cable
Range:	in open space up to 200 m
<b>Other data</b>	
Operating temperature:	-15 to + 50 °C
Operating position:	any
Mounting:	free at lead-in wires
Protection:	IP30
Overvoltage category:	III.
Contamination degree:	2
Connecting conductor cross-section (mm <sup>2</sup> ):	0.2 - 1.5 mm <sup>2</sup> solid / flexible
Dimensions:	43 x 44 x 22 mm
Weight:	45 g
Related standards:	EN 60730, EN 63044, EN 300 220, EN 301 489

- The switching unit for shutters has 2 output channels used to control garage doors, gates, blinds, awnings...
- They can be combined with Controllers or iNELS Wireless System Components.
- The BOX version offers mounting directly in the installation box, ceiling or motor drive cover.
- RFJA-32B-SL: connection of switched load 2x 8 A (2x 2000 W), with the possibility of connecting existing wire buttons.
- Short presses of the controller allow tilting of the slats, long pressing of the raise / lower moves the blinds to the end position.
- Each component can be controlled by up to 25 channels (1 channel represents one assigned controller).
- The programming button on the device also serves as a manual output control.
- For components, the repeater function can be set via the RFAF / USB service device.
- Range up to 200 m (outdoors), in case of insufficient signal between the controller and the device, use the RFRP-20N signal repeater or components with the RFIO2 protocol that support this function.
- The contact material of the AgSnO<sub>2</sub>.

### Device description

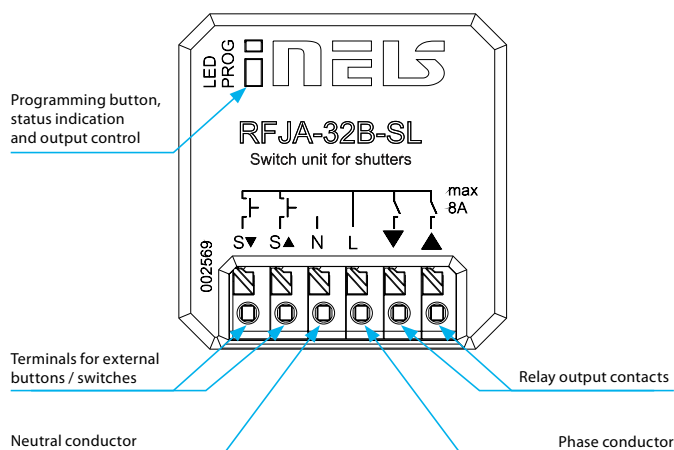

### Function description

1. As long as the button on the remote control is pressed for <2 s, the blinds move upwards (▲) or downwards (▼).
2. When the button is pressed for >2 s, the blinds move upwards (▲) or downwards (▼) to the end position.

### Connection

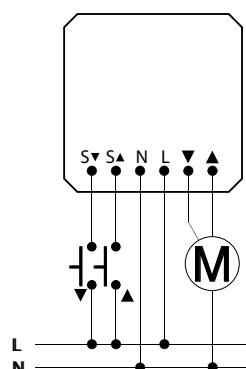



EAN code:  
 RFS-61MI: 8595188181549  
 RFS-61M: 8595188137003

Technical parameters	RFS-61MI/230V	RFS-61M/230V
Supply voltage:	110–230 V AC	
Supply voltage frequency:	50–60 Hz	
Apparent input:	2.7 VA cos φ= 0.6	
Dissipated power:	1.62 W	
Supply voltage tolerance:	+10%/-25 %	
<b>Output</b>		
Number of contacts:	1x changeover	
Rated current:	16 A/AC1	
Switching power:	4000 VA/AC1, 384 W/DC	
Peak current:	30 A/<3 s	
Switching voltage:	250 V AC1/24 V DC	
Contact material:	AgSnO <sub>2</sub>	
Mechanical service life:	3x10 <sup>7</sup>	
Electrical service life (AC1):	0.7x10 <sup>5</sup>	
<b>Control</b>		
Wireless:	up to 25-channels (buttons)	
Communication protocol:	RFIO2	
Frequency:	866–922 MHz (for more information see p. 77)	
Repeater function:	yes	
Manual control:	PROG (ON/OFF) button	
Range:	in open space up to 200 m	
Wireless Antenna:	integrated	external *
<b>Other data</b>		
Operating temperature:	-15 °C to +50 °C	
Operating position:	any	
Mounting:	DIN rail EN 60715	
Protection:	IP20 from the front panel	
Overvoltage category:	III.	
Contamination degree:	2	
Connecting conductor cross-section (mm <sup>2</sup> ):	max. 1x 2.5, max. 2x 1.5/ with a hollow max. 1x 2.5	
Dimensions:	90 x 17.6 x 64 mm	
Weight:	69 g	75 g
Related standards:	EN 60730, EN 63044, EN 300 220, EN 301 489	

- **RFS-61M:** the switching unit with 1 output channel 16 A is used for controlling appliances, sockets or lights.
  - the 1-MODULE design of the unit into a switchboard.
  - the switching unit may be controlled by up to 25-channels.
  - the package includes an internal antenna AN-I, in case of locating the element in a metal switchboard, you can use the external antenna AN-E for better signal reception, see accessories on p. 75.
- **RFS-61MI:** same design and function as RFS-61M, but with integrated antenna. It is suitable for placement in cabinets with plastic doors.
- 6 function: button, impulse relay and time function of delayed start or return with time setting range of 2 s – 60 min. Function description can be found on p. 82.
- The programming button on the unit is also used for manual control of the output.
- Memory status can be pre-set in the event of a power failure.

Device description

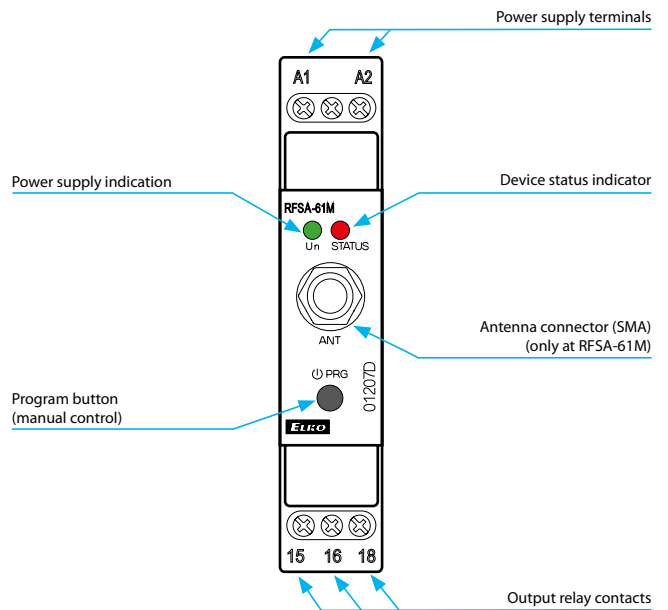

Connection

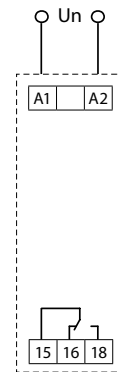

\* AN-I antenna (with SMA connector) is part of packaging. Other antennas with cable are available on the p. 72. Max tightening torque for antenna's connector is 0.56 Nm.



EAN code:

RFSA-66MI/230V: 8595188181556 RFSA-66M/230V: 8595188137003  
 RFSA-66MI/24V: 8595188181563 RFSA-66M/24V: 8595188152914

Technical parameters	RFSA-66MI/230V	RFSA-66MI/24V	RFSA-66M/230V	RFSA-66M/24V
Supply voltage:	110–230 V AC	12–24 V AC/DC	110–230 V AC	12–24 V AC/DC
SELV:	no	yes	no	yes
Supply voltage frequency:	AC 50–60 Hz			
Apparent input:	min. 2 VA/ max. 5 VA	-	min. 2 VA/ max. 5 VA	-
Dissipated power:	min. 0.5W/ max. 2.5W	max. 1.8 W	min. 0.5W/ max. 2.5W	max. 1.8 W
Supply voltage tolerance:	+10%/-25 %			

### Output

Number of contacts:	3x ECO, 3x NO
Rated current:	8 A/AC1
Switching power:	2000 VA/AC1
Peak current:	10 A/<3 s
Switching voltage:	250 V AC1
Contact material:	AgSnO <sub>2</sub>
Mechanical service life:	1x10 <sup>7</sup>
Electrical service life (AC1):	1x10 <sup>5</sup>

### Control

Wireless:	up to 25-channels (buttons)			
Communication protocol:	RFIO2			
Frequency:	866–922 MHz (for more information see p. 77)			
Repeater function:	yes			
Manual control:	PROG (ON/OFF) button			
Range:	in open space up to 200 m			
Wireless Antenna:	integrated	external *	integrated	external *

### Other data

Operating temperature:	-15 °C to +50 °C	
Operating position:	any	
Mounting:	DIN rail EN 60715	
Protection:	IP20 from the front panel	
Overvoltage category:	III.	
Contamination degree:	2	
Connecting conductor cross-section (mm <sup>2</sup> ):	max. 1x 2.5, max. 2x 1.5/ with a hollow max. 1x 2.5	
Dimensions:	90 x 52 x 65 mm	
Weight:	171 g	179 g
Related standards:	EN 60730, EN 63044, EN 300 220, EN 301 489	

\* AN-I antenna (with SMA connector) is part of packaging.  
 Other antennas with cable are available on the p. 72.  
 Max tightening torque for antenna's connector is 0.56 Nm.

- **RFSA-66M:** the switching unit with 6 output channels 8 A is used for independent control of up to 6 appliances, sockets or lights.
  - the 3-MODULE design of the unit into a switchboard.
  - each of the channels may be controlled by up to 25-channels.
  - the package includes an internal antenna AN-I, in case of locating the element in a metal switchboard, you can use the external antenna AN-E for better signal reception, see accessories on p. 75.
- **RFSA-66MI:** same design and function as RFSA-66M, but with integrated antenna. It is suitable for placement in cabinets with plastic doors.
- 6 function: button, impulse relay and time function of delayed start or return with time setting range of 2 s – 60 min. Function description can be found on p. 82.
- The programming button on the unit is also used for manual control of the output.
- Memory status can be pre-set in the event of a power failure.

### Device description

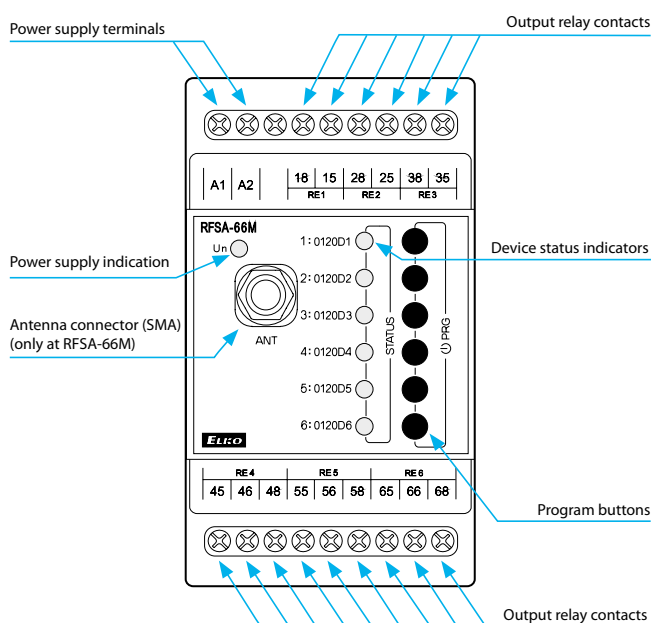

### Connection

RFSA-66MI/230V  
 RFSA-66M/230V

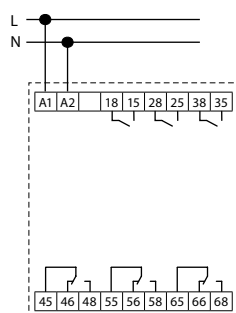

RFSA-66MI/24V  
 RFSA-66M/24V

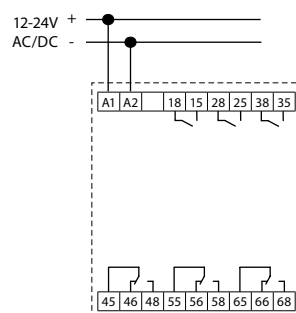



EAN code:  
 RFUS-61/230V: 8595188145268  
 RFUS-61/120V: 8595188152570

Technical parameters		RFUS-61/230V
Supply voltage:		230 V AC
Supply voltage frequency:		50–60 Hz
Apparent power:		5 VA/cos φ= 0.1
Dissipated power:		0.6 W
Supply voltage tolerance:		+10 %; -15 %
Output		
Rated current:		1x switching (AgSnO <sub>2</sub> )
Number of contacts:		12 A/AC1
Switching power:		3000 VA/AC1, 384 W/DC
Peak current:		30 A/<3 s
Switching voltage:		250 V AC1/24 V DC
Min. switching power DC:		500 mW
Mechanical service life:		3x10 <sup>7</sup>
Electrical service life (AC1):		0.7x10 <sup>5</sup>
Control		
Wireless:		up to 25-channels (buttons)
Communication protocol:		RFIO2
Frequency:		866–922 MHz (for more information see p. 77)
Repeater function:		yes
Manual control:		PROG (ON/OFF) button
Range:		in open space up to 200 m
Other data		
Operating temperature:		-15 to +50 °C
Operating position:		any
Mounting:		screws
Protection:		IP65
Overvoltage category:		III.
Contamination degree:		2
Cross-section of connecting wires (mm <sup>2</sup> ):		max. 1x 2.5, max. 2x 1.5/ with a hollow max. 1x 2.5
Recommended power cord:		CYKY 3x1.5 (CYKY 4x1.5)
Dimensions:		136 x 62 x 34 mm
Weight:		146 g
Related standards:		EN 60730, EN 63044, EN 300 220, EN 301 489

- The switching unit with 1x 12 A output channel is used for controlling appliances, sockets or lights.
- They can be combined with detectors, controllers, iNELS Wireless or system components.
- Multi-function design – button, impulse relay and time function of delayed ON or OFF with time setting of 2 s – 60 min. Function description can be found on p. 82.
- The switching unit may be controlled by up to 25-channels.
- The programming button on the unit is also used for manual control of the output.
- Range up to 200 m (in open space), if the signal is insufficient between the controller and unit, use the signal repeater RFRP20 or protocol component RFIO2 that support this feature.
- Communication frequency with bidirectional protocol RFIO2.

Device description

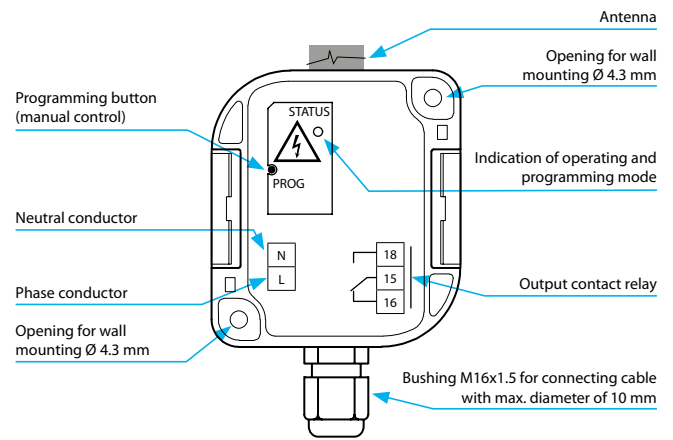

Connection

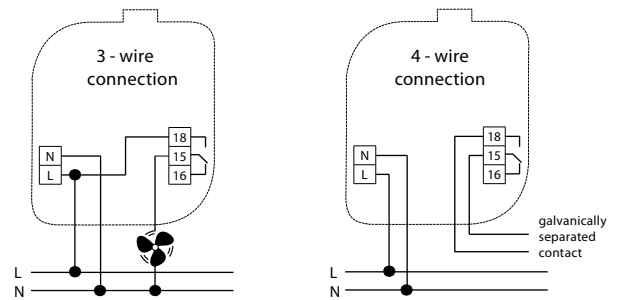



EAN code:

RFSC-61N/Schuko: 8595188182508

RFSC-61N/British: 8595188182522

RFSC-61N/French: 8595188182515

### Technical parameters RFSC-61N/230V

Supply voltage:	230 V AC
Supply voltage frequency:	50-60 Hz
Apparent power:	7 VA / $\cos \varphi = 0.1$
Dissipated power:	0.7 W
Supply voltage tolerance:	+10 %; -15 %

### Output

Number of contacts:	1x switching
Rated current:	16 A / AC1
Switching power:	4000 VA / AC1
Peak current:	30 A / <3 s
Switching voltage:	250 V AC1
Min. switching power DC:	500 mW
Mechanical service life:	10x10 <sup>6</sup>
Electrical service life (AC1):	0.7x10 <sup>5</sup>

### Control

Wireless:	up to 32-channels (buttons)
Communication protocol:	RFIO2
Frequency:	866-922 MHz (for more information see p. 77)
Repeater function:	no
Manual control:	button PROG (ON/OFF)
Range:	in open space up to 200 m

### Other data

Operating temperature:	-15 to +50 °C
Working position:	any
Mounting:	plug into a socket
Protection:	IP30
Overvoltage category:	III.
Contamination degree:	2
Dimensions:	63 x 110 x 74 mm
Weight:	129 g
Related standards:	EN 60730, EN 63044, EN 300 220, EN 301 489

- The switched socket is used to control fans, lamps, direct heaters and appliances, which are connected by a power cord with a plug up to 16 A.
- They can be combined with detectors, controllers or iNELS Wireless system components.
- Multifunctional design - button, impulse relay and time functions of delayed start or return with time setting 2 s - 60 min. (see p. 82)
- The switched socket can be controlled by up to 32 channels.
- The programming button on the socket also serves as a manual output control with indication.
- Possibility to set the output status memory in case of failure and subsequent power recovery.
- Range up to 200 m (outdoors) (in case of insufficient signal between the controller and the device, use the RFRP-20N signal repeater) or components with the RFIO2 protocol that support this function.
- Thanks to the socket design, installation is simple and straightforward by plugging it into an existing socket.
- The contact material of the AgSnO2 relay enables switching of light ballasts.

Produced in 3 designs of sockets/plugs:



### Device description

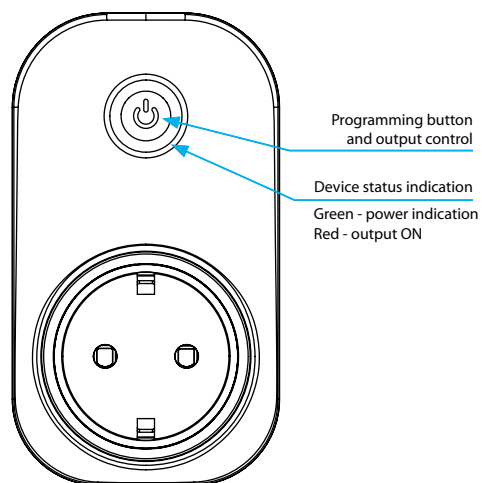



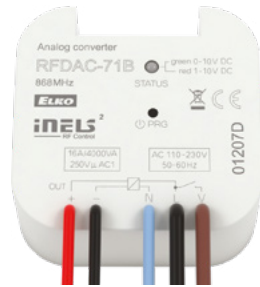

EAN code:  
RFDAC-71B: 8595188142809

Technical parameters	RFDAC-71B
Supply voltage:	110–230 V AC
Supply voltage frequency:	50–60 Hz
Apparent input:	3 VA
Dissipated power:	1.2 W
Supply voltage tolerance:	+10/-15 %

Control	
Potential-free analog output/max. current:	0(1)–10 V/10 mA
Rated current:	1x AgSnO <sub>2</sub> switches the phase conductor
Rated current:	16 A/AC1
Switching power:	4000 VA/AC1
Switching voltage:	250 V AC1
Mechanical service life:	3x10 <sup>7</sup>
Electrical service life:	0.7x10 <sup>5</sup>
Indication:	red LED/green LED
Output selection:	0(1)–10V/PROG button

Control	
Wireless:	up to 25-channels (buttons)
Communication protocol:	RFIO2
Frequency:	866–922 MHz (for more information see p. 77)
Repeater function:	yes
Manual control:	button PROG (ON/OFF)
Range:	in open space up to 200 m
Minimal control distance:	20 mm

Other data	
Operating temperature:	-15 to + 50 °C
Operating position:	any
Mounting:	plug into a socket
Protection:	IP30
Overvoltage category:	III.
Contamination degree:	2
Terminals (CY wire, cross-section):	3 x 0.75 mm <sup>2</sup> , 2 x 2.5 mm <sup>2</sup>
Length of terminals:	90 mm
Dimensions:	49 x 49 x 21 mm
Weight:	52 g
Related standards:	EN 60730, EN 63044, EN 300 220, EN 301 489

- The device with analog output 0(1)–10 V is used to control devices, luminaires, thermal actuators and thermal heads – which are equipped with such an input.
- They can be combined with detectors, controllers, iNELS Wireless or system components.
- Potential free analog output 0(1)–10 V, contact relay 16 A.
- 6 light functions – smooth increase or decrease with time setting 2 s–30 min. Function description can be found on p. 82.
- The analog controller may be controlled by up to 25-channels.
- The programming button on the controller is also used for manual control of the output.
- Memory status can be pre-set in the event of a power failure.
- Range up to 200 m (in open space), if the signal is insufficient between the controller and unit, use the signal repeater RFRP-20N or protocol component RFIO2 that support this feature.
- The BOX design lets you mount it right in an installation box, a ceiling or light cover.

Device description

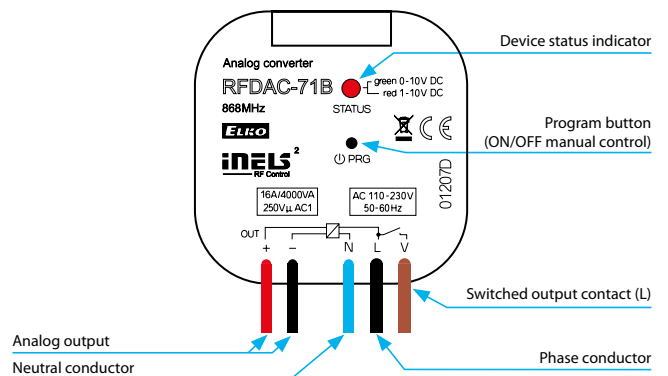

Connection

Connection example: dimming of fluorescent tubes with dimmable ballast

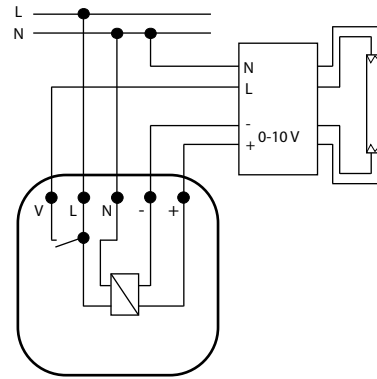

Connection example: with thermo valve

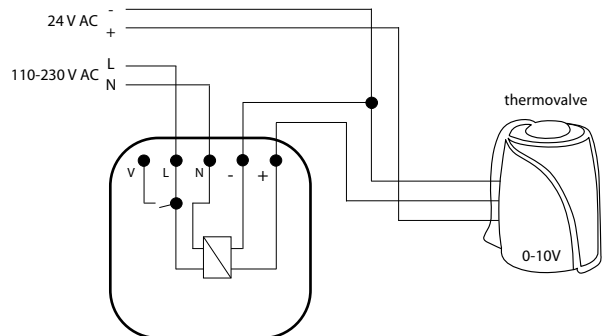



EAN code:  
RFDEL-71B-SL: 8595188183611

Technical parameters		RFDEL-71B-SL/230V
Supply voltage:		230 V AC / 50 Hz
Supply voltage frequency:		50-60 Hz
Apparent power:		5 VA / $\cos \varphi = 0.1$
Dissipated power:		0.5 W
Supply voltage tolerance:		+10/-15 %
Connection:		4-wire, with "NEUTRAL"
Output		
Dimmed load:		R, L, C, LED, ESL
Contactless:		2 x MOSFET
Load capacity*:		max. 300 W*
Control		
Wireless:		up to 25-channels (buttons)
Communication protocol:		RFIO2
Frequency:		866-922 MHz (for more information see p. 77)
Repeaterfunction:		yes
Range:		up to 200 m
Manual control:		tlačítko PROG (ON/OFF)
External button / switch:		yes
Other data		
Operating temperature:		-15 to + 45 °C
Working position:		any
Mounting:		free at lead-in wires
Protection:		IP40
Overvoltage category:		III.
Contamination degree:		2
Connection:		screwless terminals
Connecting conductor:		0.2-1.5 mm <sup>2</sup> solid/flexible
Dimensions:		43 x 44 x 22 mm
Weight:		30 g
Related standards:		EN 60730, EN 63044, EN 300 220, EN 301 489

- Universal built-in dimmer is used to regulate light sources:
  - R – classic light bulbs,
  - L – halogen bulbs with wound transformer,
  - C – halogen bulbs with electronic transformer,
  - ESL – dimmable energy saving lamps,
  - LED – LED light sources (230 V).
- They can be combined with Detectors, Controllers or iNELS Wireless System Elements.
- 7 light functions - smooth start or stop with time setting 2 s-30 min., function description p. 82.
- Min. brightness eliminates flickering LED and ESL light sources.
- The universal dimmer can be controlled by up to 25 channels
- Control input "S" for connecting an existing wired button.
- The programming button on the device also serves as a manual output control.
- Possibility to set memory status in case of power failure.
- The repeater function of the components can be set via the RFAF / USB service device.
- Range up to 200 m (outdoors), in case of insufficient signal between the controller and the component, use the RFRP-20N signal repeater or components with the RFIO2 protocol that support this function.
- The BOX version offers mounting directly in the installation box, ceiling or luminaire cover.

#### Device description

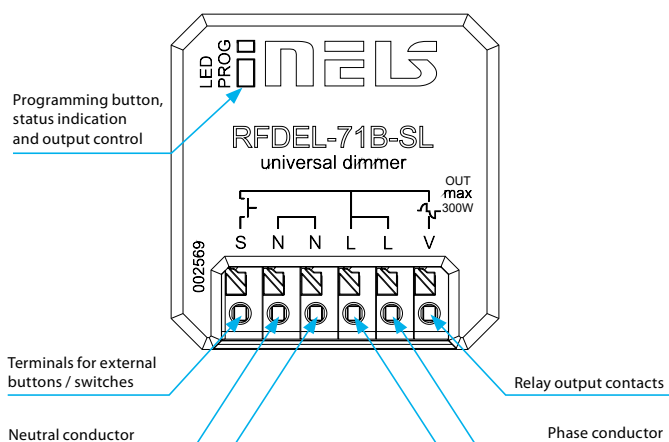

#### Connection

#### Types of connectable loads

R resistive	L inductive	C capacitive	LED light	ESL saving

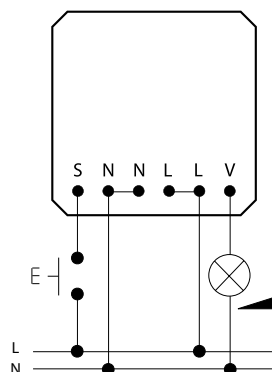

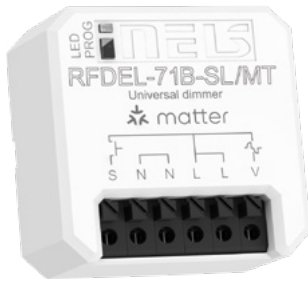

EAN code:  
RFDEL-71B-SL: 8595188189551

Technical parameters	RFDEL-71B-SL/MT
Supply voltage:	230 V AC / 50 Hz
Supply voltage frequency:	50-60 Hz
Apparent power:	5 VA / $\cos \varphi = 0.1$
Dissipated power:	0.5 W
Supply voltage tolerance:	+10/ -15 %
Connection:	4-wire, with "NEUTRAL"
<b>Output</b>	
Dimmed load:	R, L, C, LED, ESL
Contactless:	2 x MOSFET
Load capacity*:	max. 300 W*
<b>Control</b>	
Application protocol:	Matter
Communication protocol:	THREAD
Signal transmission method:	MESH
Frequency:	2.4 GHz
Range:	up to 200 m
Manual control:	button PROG (ON/OFF)
External button / switch:	yes
<b>Other data</b>	
Operating temperature:	-15 to +45 °C
Working position:	any
Mounting:	free at lead-in wires
Protection:	IP40
Overvoltage category:	III.
Contamination degree:	2
Connection:	screwless terminals
Connecting conductor:	0.2-1.5 mm <sup>2</sup> solid/flexible
Dimensions:	43 x 44 x 22 mm
Weight:	30 g
Related standards:	EN 60730, EN 63044, EN 300 220, EN 301 489

The given value is for load R, see table p. 70

**Types of connectable loads**

R resistive	L inductive	C capacitive	ESL light bulbs	LED light bulbs

- Universal built-in dimmer is used to regulate light sources:
  - R – classic light bulbs,
  - L – halogen bulbs with wound transformer,
  - C – halogen bulbs with electronic transformer,
  - ESL – dimmable energy saving lamps,
  - LED – LED light sources (230 V).
- The Thread protocol guarantees compatibility with other products with the Matter support.
- Control input "S" for connection of the existing wired pushbutton.
- The programming pushbutton on the element can also be used as manual control of the output.
- The applicable reach is up to 200m (in free area).
- The BOX design offers installation directly in the junction box, soffit or cover of the light fitting.
- The element with the controller can be paired through a border router supporting Matter and through an application supporting Matter. The border router is understood as equipment such as HomePod Mini, Google Nest Hub or Samsung SmartThings Station.

**Device description**

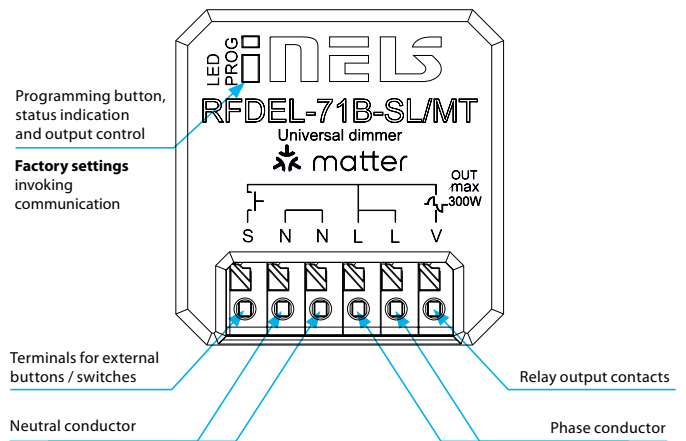

**Connection**

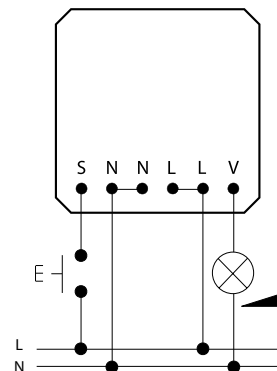



EAN code:  
RFDALI-04B-SL: 8595188185271

RFDALI-32B-SL: 8595188184342

Technical parameters	RFDALI-04B-SL   RFDALI-32B-SL
Supply voltage:	100-230 V AC / 50 Hz
Supply voltage frequency:	50/60 Hz
Apparent power:	5 VA / $\cos \varphi = 0.1$
Dissipated power:	3 W
Supply voltage tolerance:	+10/-15 %
Connection:	4-wire, L, N, DA+, DA-
<b>Output DALI</b>	
Number of devices:	max. 4   max. 32
Power supply:	16V/100 mA
<b>Control</b>	
Wireless:	128-channels
Communication protocol:	iNELS Wireless
Frequency:	866-922 MHz (for more information see p. 77)
Repeater function:	yes
Range:	up to 200 m
Manual control:	button PROG (ON/OFF)
External button / switch:	yes
<b>Configuration</b>	
Interface	WiFi AP 2.4 GHz, webserver
Application	Internet browser
<b>Other data</b>	
Operating temperature:	-15 to + 50 °C
Working position:	any
Mounting:	free at lead-in wires
Protection:	IP40
Overvoltage category:	III.
Contamination degree:	2
Connection:	screwless terminals
Connecting conductor:	0.2-1.5 mm <sup>2</sup> solid/flexible
Dimensions:	43 x 44 x 22 mm
Weight:	52g
Related standards:	EN 60730, EN 63044, EN 300 220, EN 301 489, EN 300 328

- The DALI controllers RFDALI-04B-SL and RFDALI-32B-SL are designed to control devices with a DALI interface, such as dimmers, electronic ballasts, LED converters and more.
- The control is performed by components from the iNELS Wireless system, detectors, controllers or system devices.
- Assignment and configuration of DALI devices is performed via webserver.
- The DALI bus is powered by the DALI controller.
- Control input "S" for connecting and controlling external buttons.
- The PROG button on the transmitter also serves as a manual output control.
- Possibility to set memory status in case of power failure.
- The repeater function of the components can be set via webserver.
- Range up to 200 m (outdoors), in case of insufficient signal between the controller and the device, use the RFRP-20N signal repeater or components with the RFIO2 protocol that support this function.
- The BOX version offers mounting directly in the installation box, ceiling or luminaire cover, screwless terminals for connection.

### Device description

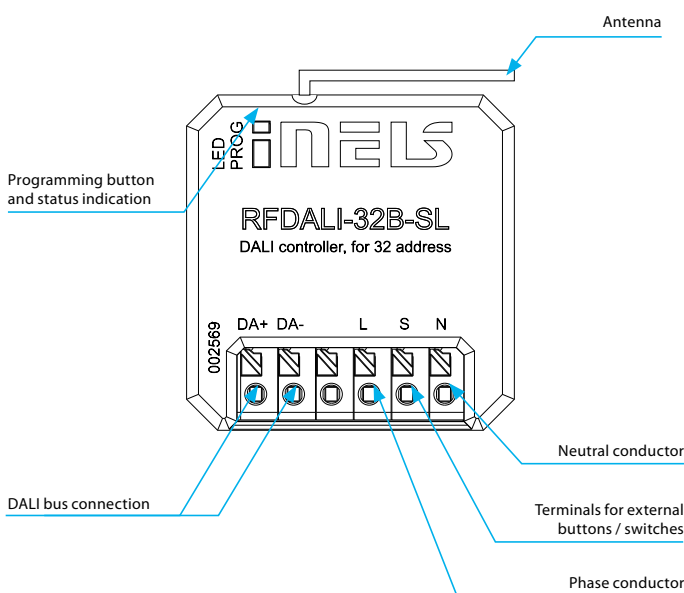

### Connection

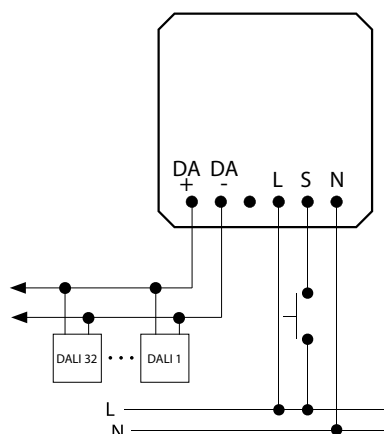



EAN code:  
RFDEL-71M: 8595188148979

Technical parameters	RFDEL-71M/230V	RFDEL-71M/120V
Supply voltage:	230 V AC	120 V AC
Supply voltage frequency:	50 Hz	60 Hz
Apparent power:	2.5 VA	1.1 VA
Dissipated power:	0.8 W	0.6 W
Supply voltage tolerance:	+10/-15 %	
<b>Output</b>		
Dimmed load:	R,L,C, LED, ESL	
Contactless:	2 x MOSFET	
Load capacity*:	max. 600 W	max. 300 W*
<b>Control</b>		
Wireless:	up to 32 channels (buttons)	
Communication protocol:	RFIO2	
Frequency:	866–922 MHz (for more information see p. 77)	
Repeater function:	yes	
Range:	in open space up to 160 m	
Manual control:	SW (ON/OFF) button	
External button:	max. 50 m cable	
Glow lamps connection:	no	
Analog control:	potentiometer or 0 (1)–10 V	
Wireless Antenna:	AN-I included (SMA connector**)	
<b>Other data</b>		
Operating temperature:	-20 to +35 °C	
Storage temperature:	-30 to +70 °C	
Operating position:	vertical	
Mounting:	DIN rail EN 60715	
Protection:	IP20 under normal conditions	
Overvoltage category:	II.	
Contamination degree:	2	
Cross-section of connecting wires:	max. 1x 2.5, max. 2x 1.5/with a hollow max. 1x 2.5	
Dimensions:	90 x 52 x 65 mm	
Weight:	125 g	
Related standards:	EN 60730, EN 63044, EN 300 220, EN 301 489	

- The universal modular dimmer is used to regulate light sources:
  - R – classic lamps (resistive load)
  - L – halogen lamps with wound transformer (inductive load)
  - C – halogen lamps with electronic transformer (capacity load)
  - ESL – dimmable energy-efficient fluorescent lamps
  - LED – LED light sources equipped with LED.
- Control can be performed by:
  - a) detectors, Controllers and System units iNELS Wireless
  - b) by control signal 0(1)–10 V
  - c) potentiometer
  - d) existing button in the installation.
- 6 light functions – smooth increase or decrease with time setting 2 s–30 min. Function description can be found on p. 82.
- Thanks to setting the min. brightness by potentiometer, you will eliminate flashing of the LED and ESL light sources.
- The universal dimmer may be controlled by up to 32-channels.
- The programming button on the controller is also used for manual control of the output.
- The package includes an internal antenna AN-I, in case of locating the unit in a metal switchboard, you can use the external antenna AN-E for better signal reception, see accessories on p. 75.
- Memory status can be pre-set in the event of a power failure.
- Range up to 160 m (in open space), if the signal is insufficient between the controller and unit, use the signal repeater RFRP-20N or protocol component RFIO2 that support this feature.
- The unit's 3-MODULE design with switchboard mounting.

**Device description**

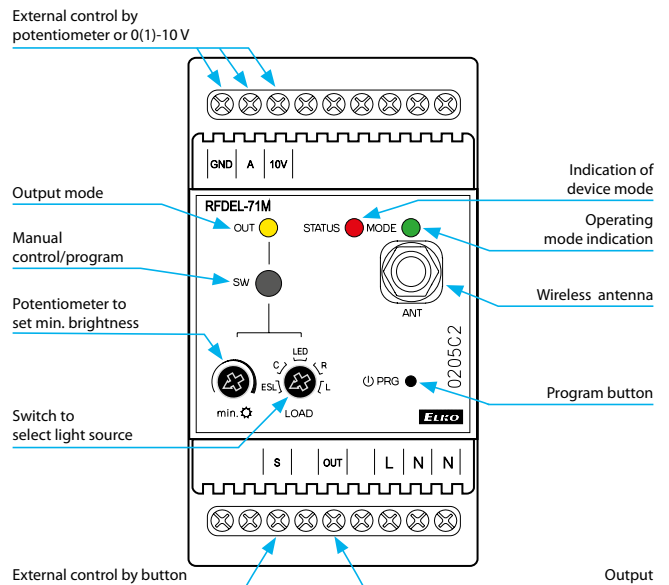

**Connection and external control options**

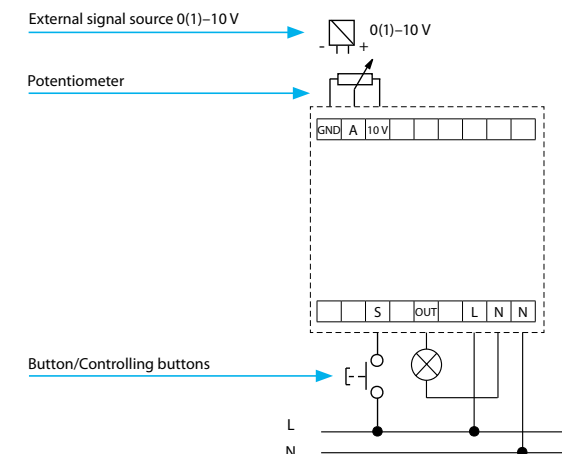

\* See page 79 for the load chart for each light source.

\*\* Max. Tightening Torque for antenna connector is 0.56 Nm.



EAN code:

RFDEL-76M/230V: 8595188182058

RFDEL-76M/120V: 8595188182096

### Technical parameters RFDEL-76M/230V RFDEL-76M/120V

Supply voltage:	230 V AC	120 V AC
Supply voltage frequency:	50 Hz	60 Hz
Power supply indication:	green LED Un	
Supply voltage tolerance:	+10/-15 %	
<b>Output</b>		
Output:	12x MOSFET transistor	
Load type *:	R - resistive, L - inductive, C - capacitive, ESL - economical, LED	
Minimum output power:	10 VA	
Max. output power/channel:	150 VA	75 VA
Possible to connect outputs:	yes	
Maximum power when connecting all outputs:	max. 900 VA	max. 450 VA
Output protection:	thermal/short-term overload/longterm overload/short circuit	
Output indication:	red LED STATUS	

### Control

Input for buttons:	potential "L" or external voltage AC 20–230 V (50–60 Hz)/DC 20–230 V
Wireless	up to 32-channels (with iNELS Wireless controllers)
Communication protocol:	RFIO2
Function repeater:	yes
Range:	in the open up to 160 m (524.11 ft)
Wireless antenna:	AN-I included (SMA connector)

### Other information

Operating temperature:	-20 to + 50 °C (-4 to 122 °F)
Storage temperature:	-30 to +70 °C (-22 to 158 °F)
Ingress protection:	IP20 under normal conditions
Overvoltage category:	II.
Contamination degree:	2
Connecting conductor:	max. 2.5 mm <sup>2</sup> /1.5 mm <sup>2</sup> with sleeve
Operating position:	vertical
Installation:	in the switchboard on DIN rail EN 60715
Design:	6-MODULE
Dimensions:	90 x 105 x 65 mm (3.5" x 4.1" x 2.6")
Weight	320 g (11 oz.)

\*Warning: it is not allowed to simultaneously connect loads of inductive and capacitive type in the same channel.

- RFDEL-76M is a universal 6-channels actuator, which is used to control the brightness intensity of dimmable sources R - L - C - LED - ESL.
- The maximum possible load is 150 VA for 230 V and 75 VA for 120 V for each channel.
- The individual channels of the dimmer can be connected in parallel and thus increase the maximum output load at the expense of the number of outputs.
- Each of the output channels is individually controllable and addressable.
- By setting the min. brightness eliminates flickering of different types of light sources, setting min. brightness and type of load is done using the PROG buttons.
- Electronic overcurrent, thermal and short-circuit protection, which switches off the output.
- 6 galvanically isolated inputs for wired buttons, which can be used to control the outputs independently of the iNELS Wireless.
- The package includes an internal AN-I antenna, in case of placement of a sheet metal distribution element, you can use an external AN-E antenna to improve the signal.



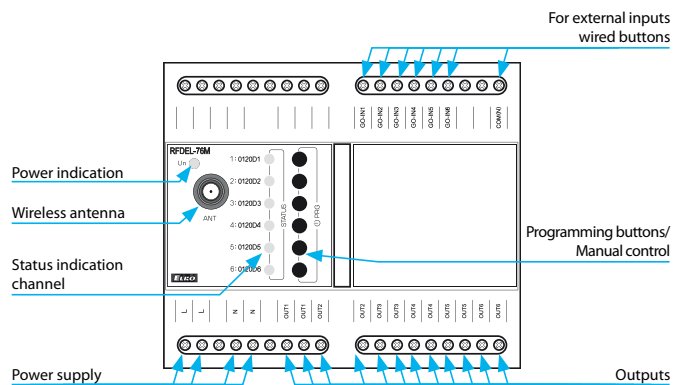

### Description

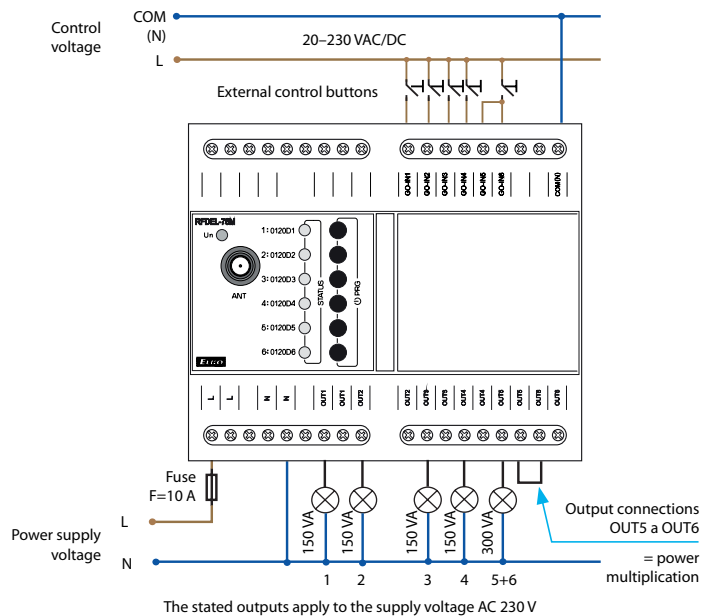

### Connection



### Types of connectable loads

 HAL 230 V	 HAL 12-24 V			
R resistive	L inductive	C capacitive	LED light	ESL saving



EAN code:  
RFDA-73M/RGB: 8595188146814

Technical parameters	RFDA-73M/RGB
Supply terminals:	Un+, GND
Supply voltage:	12–24 V DC stabilized
Maximum power without load:	0.8 W
<b>Output</b>	
Dimmed load:	LED strip 12 V, 24 V with common anode RGB LED strips 12 V, 24 V with common anode
Number of channels:	3
Rated current:	3x5 A
Peak current:	3x10 A
Switching voltage:	Un
<b>Control</b>	
Wireless:	up to 32-channels (buttons)
Communication protocol:	RFIO2
Frequency:	866–922 MHz (for more information see p. 77)
Repeater function:	yes
Load capacity of output +10 V:	10 mA
Ext. signal:	0–10 V, 1–10 V
Range:	in open space up to 160 m
Wireless Antenna:	AN-I included (SMA connector*)
<b>Other data</b>	
Operating temperature:	-20 to +50 °C
Storage temperature:	-30 to +70 °C
Working position:	any
Mounting:	DIN rail EN 60715
Protection:	IP20 from front panel
Contamination degree:	2
Cross-section of connecting wires (mm <sup>2</sup> ):	max. 1x 2.5, max. 2x 1.5/ with a hollow max. 1x 2.5
Dimensions:	90 x 52 x 65 mm
Weight:	130 g
Related standards:	EN 60730, EN 63044, EN 300 220, EN 301 489

\* Max Tightening Torque for antenna connector is 0.56 Nm.

- The dimmer for LED strips is used for independent control of 3 single-colour LED strips or one RGB LED strip.
- The expanded selection of control modes enables it to be combined with:
  - a) detectors, controllers and system units iNELS Wireless
  - b) device with output signal 0 (1)–10 V
  - c) potentiometer.
- The unit's 3-MODULE design with switchboard mounting enables connection of dimmed load 3x 5 A, which represents:
  - a) single-colour LED strip 7.2 W – 3x 8 m
  - b) RGB LED strip 14.2 W–10 m.
- 6 light functions – smooth increase or decrease with time setting 2 s – 30 min. Function description can be found on p. 82.
- The dimmer may be controlled by up to 32-channels.
- The power supply of the unit is in the range of 12–24 V DC, and is indicated by a green LED.
- The package includes an internal antenna AN-I, in case of locating the unit in a metal switchboard, you can use the external antenna AN-E for better signal reception, see accessories on p. 75.
- Memory status can be pre-set in the event of a power failure.
- Range up to 160 m (in open space), if the signal is insufficient between the controller and unit, use the signal repeater RFRP-20N or protocol component RFIO2 that support this feature.

**Device description**

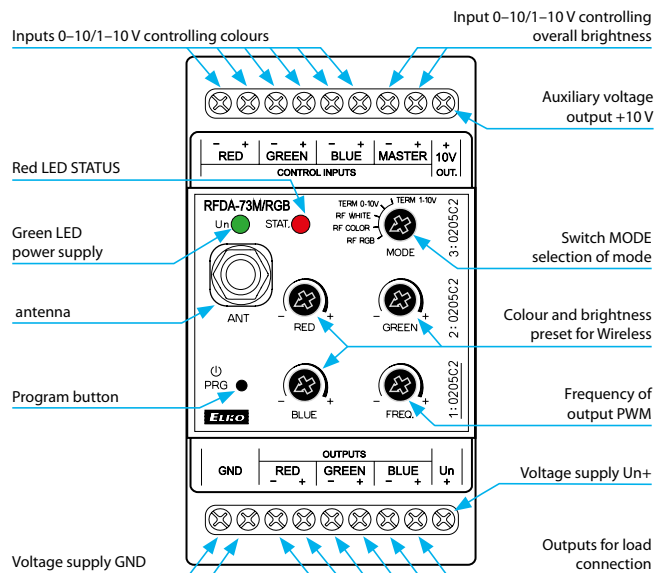

**Output variations and external control options**

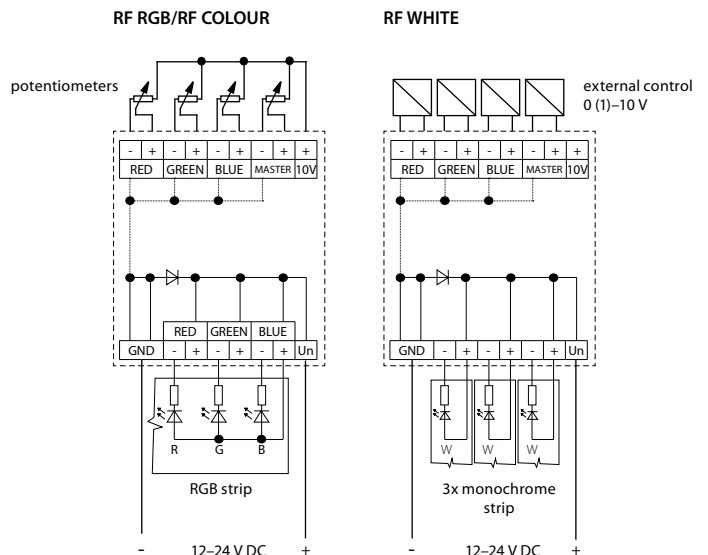

Control modes

RF RGB

Switch settings in MODE:

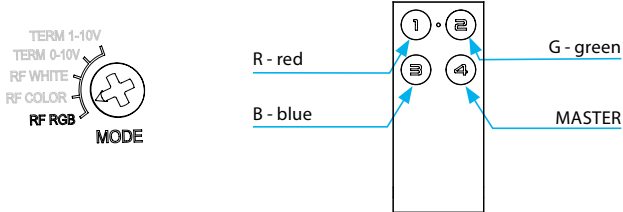

RF RGB mode for controlling RGB LED strips. In the RF RGB programming mode, colours are automatically assigned to individual transmitter buttons.

Note: The mode can be controlled by RF Touch, RF Pilot, RFWB-40/G, RF KEY, and eLAN-RF.

RF Color

Switch settings in MODE:

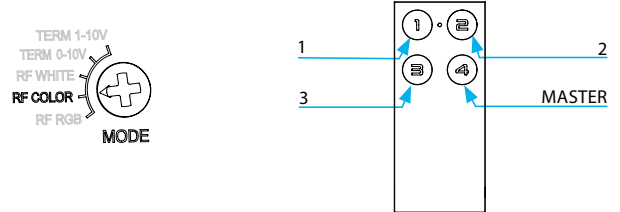

RF COLOUR mode for controlling RGB LED strips, where you can choose the colour for individual transmitter buttons. A long press of the button starts the colour search mode. After releasing the button, the current colour is set for the given button.

Note: The mode can be controlled by RF Touch, RF Pilot, RFWB-40/G, RF KEY, and eLAN-RF.

RF WHITE

Switch settings in MODE:

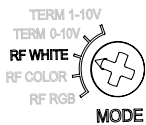

This works in a mode where it acts like three independent dimmers for 12–24 V. Each channel can be programmed independently of one another and has its own address.

Note: The mode can be controlled by RF Touch, RF Pilot, RFWB-20/G, RFWB-40/G, RF KEY and eLAN-RF.

TERM 0–10 V and TERM 1–10 V

Switch settings in MODE:



Modes TERM 0–10 V and TERM 1–10 V. Inputs 0–10 V and 1–10 V used to control one RGB LED strip or three independent single-colour LED strips (see modes above) from the iNELS BUS System. For controlling, you can use the application iHC for smartphones and tablets.

Control options

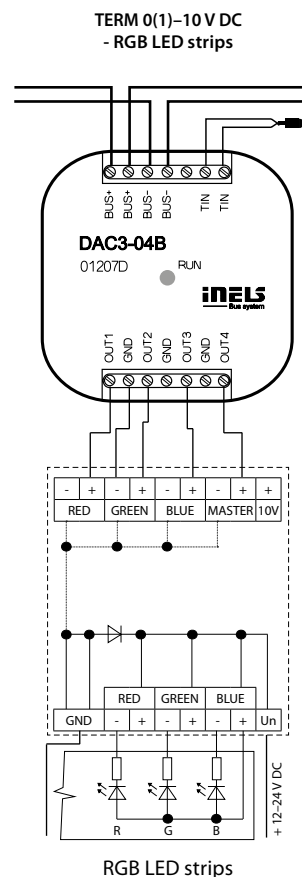
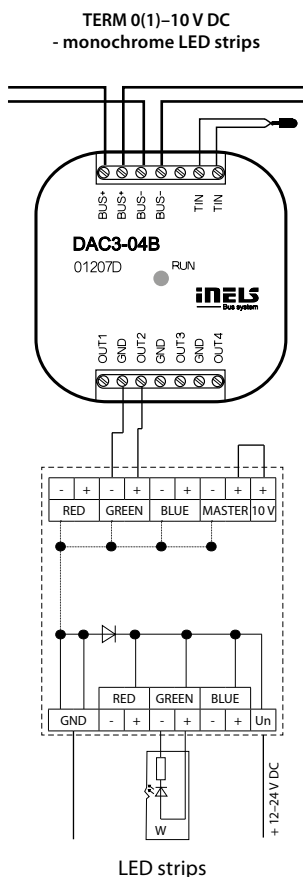





EAN code:  
 RFDSC-71N/Schuko: 8595188183604 RFDSC-71N/British: 8595188183581  
 RFDSC-71N/French: 8595188183598

Technical parameters		RFDSC-71N/230V
Supply voltage:		230 V
Supply voltage frequency:		50-60 Hz
Apparent power:		1.1 VA
Dissipated power:		0.8 W
Supply voltage tolerance:		+10/-15 %
<b>Output</b>		
Contactless:		2 x MOSFET
Load capacity:*		max. 200 W
Dimming load:		R, L, C, LED, ESL
<b>Control</b>		
Wireless:		up to 32-channels (buttons)
Communication protocol:		RFIO2
Frequency:		866-922 MHz (for more information see p. 77)
Repeater function:		no
Range:		in open space up to 160 m
Manual control:		button PROG (ON/OFF)
<b>Other data</b>		
Operating temperature:		-20 to + 35 °C
Storage temperature:		-30 to +70°C
Working position:		any
Mounting:		plug into a socket
Protection:		IP30
Overvoltage category:		III.
Contamination degree:		2
Dimensions:		63 x 110 x 74 mm
Weight:		118 g
Related standards:		EN 60730, EN63044, EN 300 220, EN 301 489

- The dimmable socket is used to regulate the brightness of the luminaires, which are connected by a power cord with a plug:
  - R - classic light bulbs (resistive load)
  - L - halogen bulbs with wound transformer (inductive load)
  - C - halogen bulbs with electronic transformer (capacitive load)
  - ESL - dimmable energy saving lamps
  - LED - light sources equipped with LED
- Multifunction - 6 light functions - smooth start or stop with time setting 2 s - 30 min. Description of functions on p. 82.
- Min. brightness potentiometer eliminates flickering of LED and ESL light sources.
- The universal dimmer can be controlled by up to 32 channels.
- The programming button on the socket also serves as a manual output control.
- Possibility to set the output status memory in case of failure and subsequent power recovery.
- Range up to 160 m (outdoors), in case of insufficient signal between the controller and the device, use the RFRP-20N signal repeater or components with the RFIO2 protocol that support this function.



**Device description**

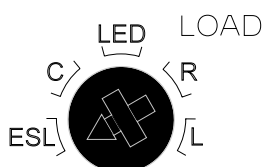
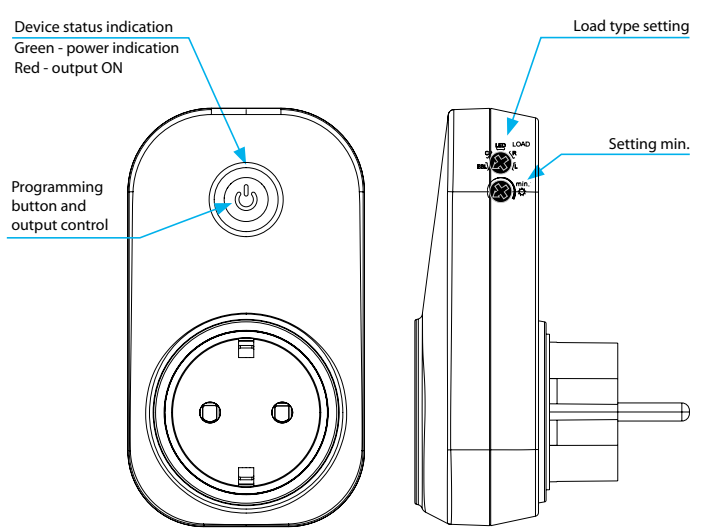

**Types of loads**

ESL	dimmable energy saving lamps
C	halogen bulbs with electronic transformer (capacitive load)
LED	LED light sources
R	classic light bulbs (resistive load)
L	halogen bulbs with wound transformer (inductive load)

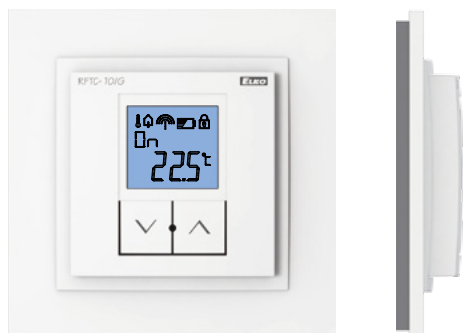

EAN code:  
RFTC-10/G: 8595188145329

Technical parameters	RFTC-10/G
Supply voltage:	2 x 1.5 V AAA batteries
Battery life:	1 year based on frequency of use
Temperature correction:	2 buttons $\nabla/\blacktriangle$
Temperature offset:	$\pm 5\text{ }^{\circ}\text{C}$
Display:	LCD, characters/see Display description
Backlighting:	active 10 s after pressing
Transmission indication/function:	symbols
Temperature measurement:	1x internal sensor
Temp. measurement range and accuracy:	0 to +55 $^{\circ}\text{C}$ ; 0.3 $^{\circ}\text{C}$ of the range

Control	
Communication protocol:	RFIO
Frequency:	866–922 MHz (for more information see p. 77)
Repeater function:	no
Signal transmission method:	bidirectionally addressed message
Range:	in open space up to 100 m
Minimum control distance:	20 mm

Other data	
Max. number of control.	
RFSA-6x:	1
Program:	x
Operating temperature:	0 to +55 $^{\circ}\text{C}$
Operating position:	wall-mounted
Mounting:	glue/screws
Protection:	IP30
Contamination degree:	2
Dimensions frame	
- plastic:	85 x 85 x 20 mm
- metal, glass, wood, granite:	94 x 94 x 20 mm
Weight:	66 g (without batteries)
Related standards:	EN 60730, EN 63044, EN 300 220, EN 301 489

Compatibility				
RF Touch	eLAN-RF	RFSA-6x/RFSAI-6x	RFSTI-11B-SL	RFATV-2
✓	✓	✓	-	-

### Display description

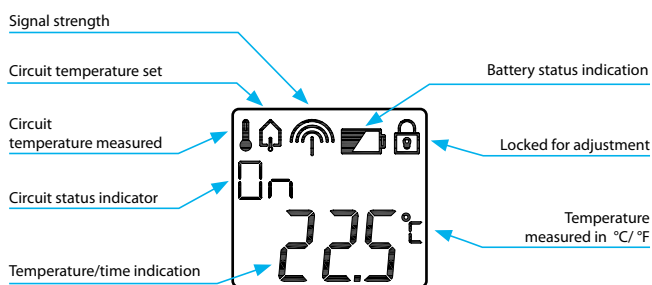

- RFTC-10/G is used for temperature measurement (in the range of 0 to 55  $^{\circ}\text{C}$ ) and correction of the pre-set temperature in RF Touch or eLAN-Wireless system devices in the range of  $\pm 5\text{ }^{\circ}\text{C}$ . The temperature correction is valid until the next program change in the given system device.
- The backlit LCD display displays the current and set temperature, status (ON/OFF), battery status, etc.
- Range up to 100 m (in open space), if the signal is insufficient between the controller and unit, use the signal repeater RFRP-20N or protocol component RFIO2 that support this feature.
- Colour combination of heating unit in design of frames LOGUS<sup>90</sup> (plastic, glass, wood, metal, stone).

### Device description

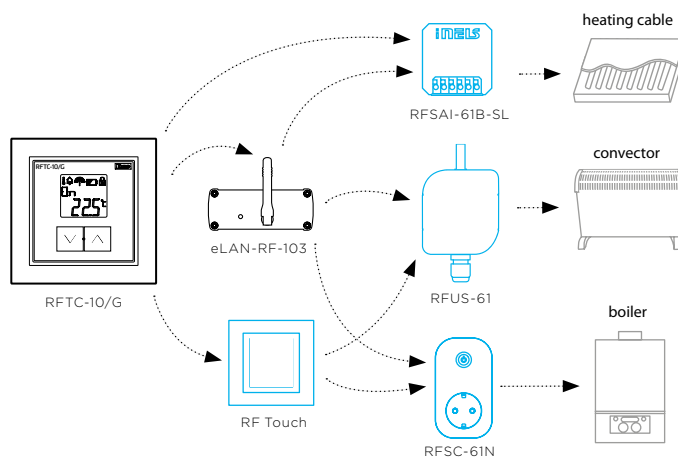
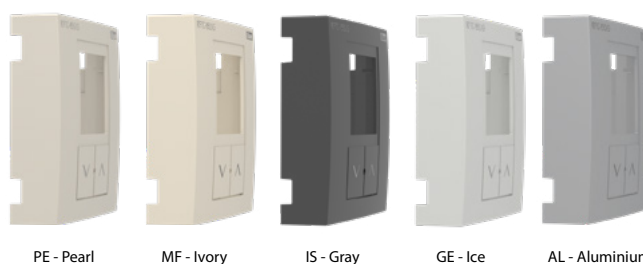
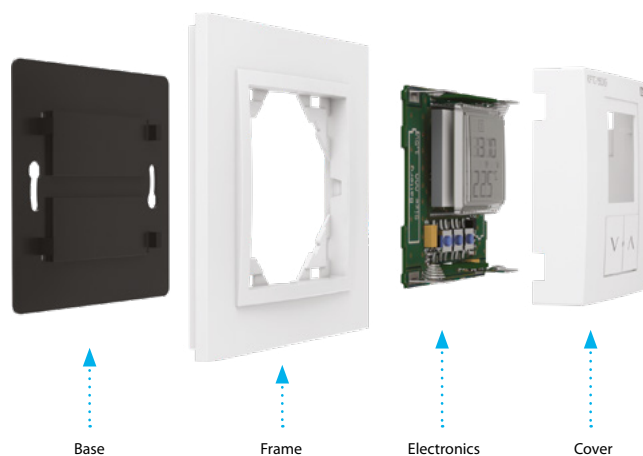



EAN code:  
RFTC-50/G: 8595188148641

Technical parameters		RFTC-50/G
Supply voltage:	2x 1.5 V AAA batteries	
Battery life:	1 year based on frequency of use according to the number of controlling actuators	
Temperature correction:	2 buttons √ / ∧	
Temperature offset:	± 5 °C	
Display:	LCD, characters/see Display description	
Backlighting:	active 10 s after pressing	
Transmission indication/function:	symbols	
Temperature measurement:	1x internal sensor	
Temp. measurement range and accuracy:	0 to +55 °C; 0.3 °C of the range	
Control		
Communication protocol:	RFIO	
Frequency:	866–922 MHz (for more information see p. 77)	
Repeater function:	no	
Signal transmission method:	bidirectionally addressed message	
Range:	in open space up to 100 m	
Minimum control distance:	20 mm	
Other data		
Max. number of control.	4	
RFSA-6x:	Weekly	
Operating temperature:	0 to + 55 °C	
Operating position:	on the wall	
Mounting:	by gluing/screwing	
Protection:	IP30	
Contamination degree:	2	
Dimensions frame		
- plastic:	85 x 85 x 20 mm	
- metal, glass, wood, granite:	94 x 94 x 20 mm	
Weight:	66 g (without batteries)	
Related standards:	EN 60730, EN 63044, EN 300 220, EN 301 489	

Compatibility				
RF Touch	eLAN-RF	RFSA-6x/RFSAI-6x	RFSTI-11B-SL	RFATV-2
-	-	✓	✓	-

Display description

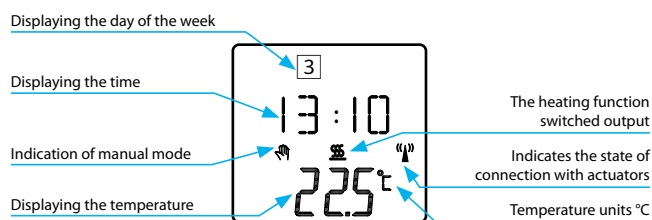

- RFTC-50/G is a separate thermostat that allows wireless control of up to 4 multifunctional switching components, e.g. RFSAI-6x, RFUS-61, RFSTI-11B.
- Temperature measurement with built-in sensor in the range of 0.55 °C, temperature setting in the range of 0 to +55 °C in the weekly program.
- The backlit LCD display displays the current and set temperature, status (ON/OFF), battery status, day of the week, current time, etc.
- Battery power (2x 1.5 V AAA batteries - included in supply) with battery life of around 1 year based on frequency of use.
- Range up to 100 m (in open space), if the signal is insufficient between the controller and unit, use the signal repeater RFRP-20N or protocol component RFIO2 that support this feature.
- Colour combination of temperature unit in design of frames LOGUS<sup>90</sup> (plastic, glass, wood, metal, stone).

Device description

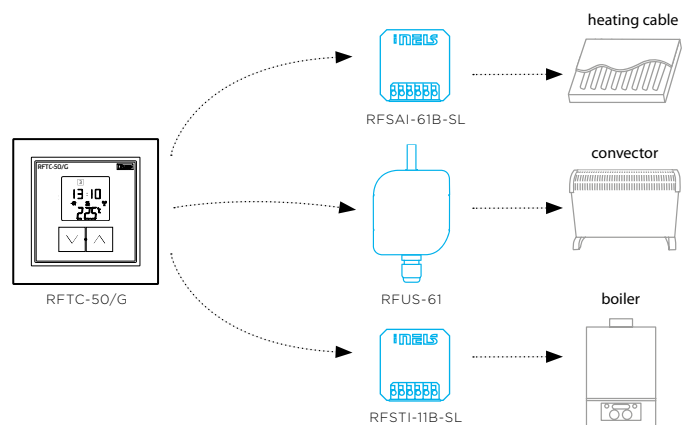
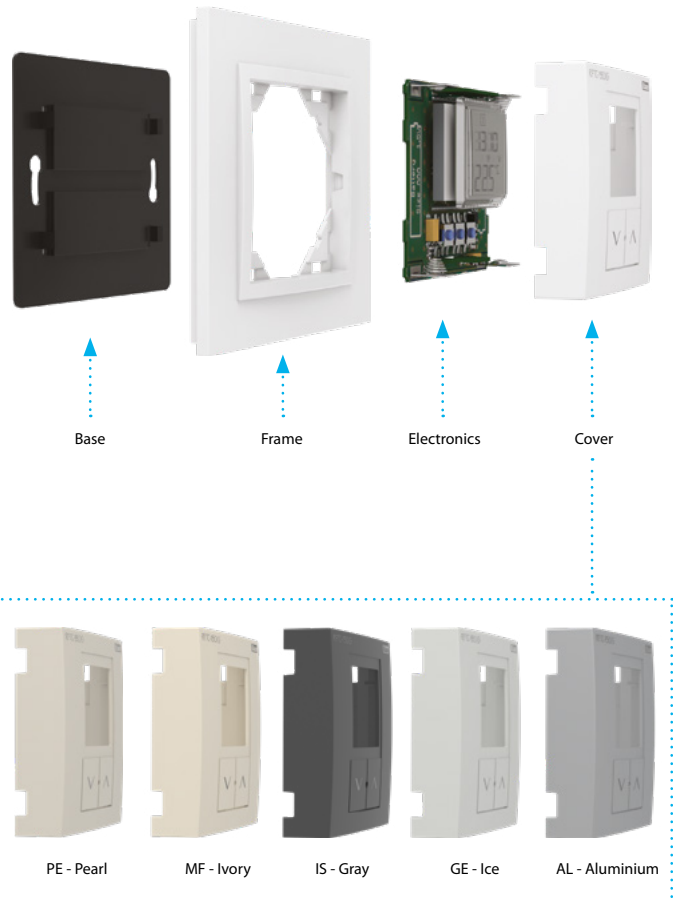



EAN code:  
RFSTI-11B-SL: 8595188184045

Technical parameters	RFSTI-11B-SL
Supply voltage:	230 V AC
Supply voltage frequency:	50-60 Hz
Apparent input:	7 VA / $\cos \varphi = 0.1$
Dissipated power:	0.7 W
Supply voltage tolerance:	+10 %; -15 %
Temp. measurement range and accuracy:	-20 to +50 °C 0.5 °C of the range
<b>Output</b>	
Number of contacts:	1x switching
Rated current:	8 A / AC1
Switching power:	2000 VA / AC1
Peak current:	10 A / <3 s
Switching voltage:	250 V AC1
Mechanical service life:	1x10 <sup>7</sup>
Electrical service life (AC1):	1x10 <sup>5</sup>
<b>Control</b>	
Wireless:	25-channels
Communication protocol:	RFIO2
Frequency:	866-922 MHz (for more information see p. 77)
Repeater function:	yes
Manual control:	button PROG (ON/OFF)
External button/switch:	yes
Range:	in open space up to 200 m
<b>Other data</b>	
Operating temperature:	-15 to +50 °C
Operating position:	any
Mounting:	free at lead-in wires
Protection:	IP40
Overvoltage category:	III.
Contamination degree:	2
Connection:	screwless terminals
Connecting conductor:	0.2-1.5 mm <sup>2</sup> solid/flexible
Dimensions:	43 x 44 x 22 mm
Weight:	31g
Related standards:	EN 60730, EN 63044, EN 300 220, EN 301 489

- The temperature element measures the temperature with an external sensor and at the same time controls the heating circuit (electric under-floor heating, air conditioning, boiler...).
- They can be combined with Detectors, Controllers or iNELS Wireless system components.
- It measures the temperature in the range -20 to +50 °C and sends it to the system component in a regular 5 min. intervals. It sends a signal when the temperature changes suddenly.
- The heating/cooling, hysteresis and offset functions are set in the system component or application.
- It allows the connection of a switched load up to 8 A (2,000 W).
- Range up to 200 m (outdoors), in case of insufficient signal between the controller and the device, use the RFRP-20N signal repeater or component with the RFIO2 protocol that support this function.
- The BOX version offers installation directly in the installation box, ceiling or cover of the controlled appliance. Easy installation thanks to screwless terminals.
- External sensor TC (-20 to +80 °C) or TZ (-40 to +125 °C) with a length of 3 m, 6 m, 12 m. See „Accessories“ on page 44.

### Device description

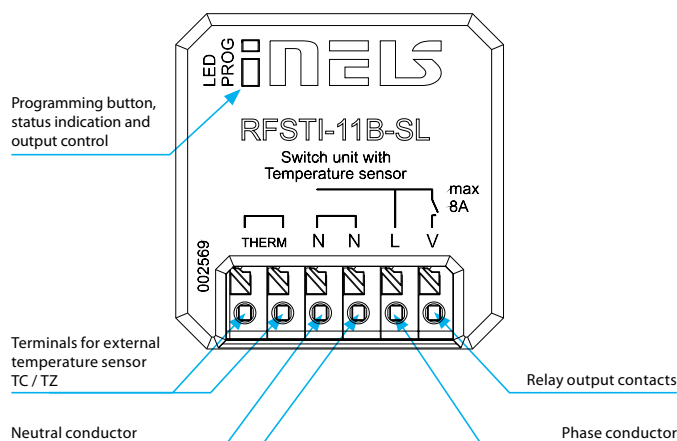

### Connection

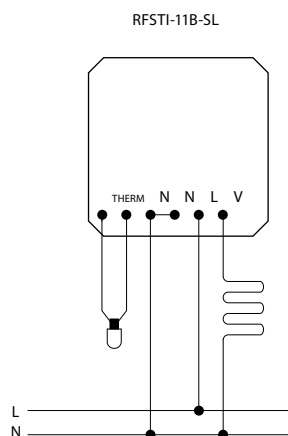



- With an integrated digital sensor, it measures temperature and humidity in the range of -10 to +50 °C and at regular intervals of 20 min. sends it to the system device (eLAN-RF, RF-Touch).
- In the event of a sudden change in temperature and humidity, it sends a signal within 1 min.
- (2x 3 V batteries CR 2032 - included in the package) with a lifetime approx. 1 year (according to ambient temperature cycling).
- Range up to 160m (in open space), in case of insufficient signal between the controller and the device, use RFRP-20N signal repeater or devices with RFIO2 protocol that support this function.

EAN code:  
RFTI-20: 8595188134019

Technical parameters		RFTI-20
Supply voltage:	2x 3 V CR 2032 battery	
Battery life:	up to 1 year, according to the number of activations	
Transmission indication/function:	red LED	
Temperature and humidity measurement:	integrated digital sensor	
Temperature measurement range and accuracy:	-10 to +50 °C; 0.5 °C of range	
Humidity measurement range and accuracy:	0 to 90 %; ±3 % of range	
Output		
Communication protocol:	RFIO	
Frequency:	866–922 MHz (see p. 77)	
Repeater function:	no	
Signal transmission:	unidirectional message	
Range:	in open space up to 160 m	
Other data		
Operating temperature:	-10 to +50 °C	
Working position:	any	
Mounting:	glue/screws/loose	
Protection:	IP30	
Contamination degree:	2	
Dimensions:	75 x 25 x 14 mm	
Weight:	45 g	
Related standards:	EN 60730, EN 63044, EN 300 220, EN 301 489	

Device description





EAN code:  
RFATV-2: 8595188182591

Technical parameters		RFATV-2
Supply voltage:	2x 1.5 V battery AA	
Battery life:	1 year based of frequency use	
<b>Control</b>		
Communication protocol:	RFIO	
Frequency:	866-922 MHz (for more information see p. 77)	
Wireless command from controller:	eLAN-RF-103, RF Touch 2	
Range:	in open space up to 200 m	
<b>Other data</b>		
Operating temperature:	0 °C to +50 °C	
Operating position:	any	
Protection:	IP40	
Dimension:	52 x 52 x 70 mm	
Thermo-valve nuts:	M 30 x 1.5	
Related standards:	EN 60730	

- The wireless thermovalve is used to regulate the temperature in the room. It is installed directly on the radiator valve, where it immediately measures the temperature in the room with the help of an internal temperature sensor and regulates the radiator valve with the built-in motor. The valve can also be installed on valves in distribution boards, when a temperature sensor from another element of the iNELS Wireless system will be used to measure the temperature in the room.
- To use the functions of the valve, it is necessary to connect it to the eLAN-RF or RF Touch system units, which will ensure heating and control of the valve from the app (Android, iOS, Samsung Smart TV) and the system unit with manual or automatic temperature modes.
- The valve measures the temperature in the range of 0°C...50°C and receives control instructions from the system units at a regular interval of every 6 minutes.
- The valve supports functions of anti-freeze mode, open window detection, communication failure with system unit and valve stiffening, which are described in detail below.
- The valve supports hysteresis and offset functions that can be set in the application or system unit.
- Battery power 2x AA 1.5 V batteries (included in the package)
- Communication range with system unit up to 200 m (in open space), to increase the range or change the direction of the signal, it is possible to use the RFRP-20NN repeater or other units of the system with support for the repeater function.
- In the base, the head is compatible with M30x1,5 valves, adapters that are not included in the package can be used for other valves.

**Device description**

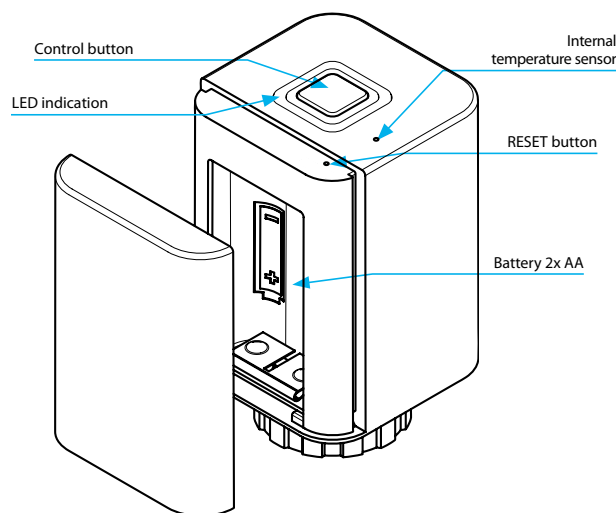

**Accessories (not included)**

RE-C Reduction Coterm	
RE-DRTD Reduction Danfoss RTD	
RE-D Reduction Danfoss	
RE-G Reduction Giacomini	
RE-M Reduction Myjava	
RE-H Reduction Herz	

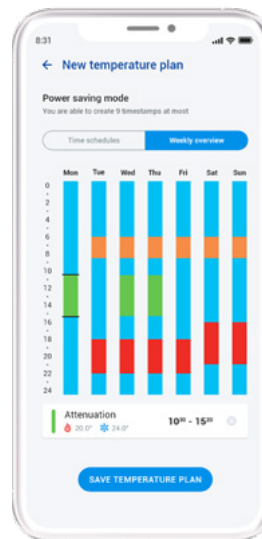

TC, TZ | Temperature sensors



EAN code:  
 TC-0: 8595188110075 TC-6: 8595188110082  
 TC-3: 8595188110617 TC-12: 8595188110099

Technical parameters	TC	TZ
Range:	-20 to +80 °C (-4 to 176 °F)	-40 to +125 °C (-40 to 257 °F)
Scanning element:	NTC 12K	NTC 12K
Tolerance:	±(0.15 °C + 0.002 t )	±(0.15 °C + 0.002 t )
In air/in water:	(τ0.5) ≤ 18 s	(τ65) 62 s/8 s
In air/in water:	(τ0.9) ≤ 48 s	(τ95) 216 s/23 s
Cable material:	PVC unshielded, 2x 0.25 mm <sup>2</sup>	silicon VO3SS-F 2D x 0.5 mm <sup>2</sup>
Terminal material:	polyamide	stainless steel
Protection degree:	IP67	IP67
Electrical strength:	2500 VAC	2500 VAC
Insulation resistance:	> 200 MΩ at 500 VDC	> 200 MΩ at 500 VDC

Types of temperature sensors:		
	TC-0	TZ-0
- length:	100 mm	110 mm
- weight:	5 g	4.5 g
	TC-3	TZ-3
- length:	3 m	3 m
- weight:	70 g	106 g
	TC-6	TZ-6
- length:	6 m	6 m
- weight:	130 g	216 g
	TC-12	TZ-12
- length:	12 m	12 m
- weight:	250 g	418 g

τ65 (95): time, which sensor needs to heat up on 65 (95) % of ambient temperature of environment, in which is located.

- Thermister temperature sensors are made of Negative Temperature Coefficient (NTC) embedded in a PVC or metal sleeve with a thermally-conductive sealer.
- **Sensor TC**  
- lead-in cable to sensor TC is made of wire CYSY 2D x 0.5 mm/0.02".
- **Sensor TZ**  
- cable VO3SS-F 2D x 0.5 mm/0.02" with silicone insulation for use in high temperature applications.  
- silicone insulation for use in high temperature applications.
- Temperature sensors can be connected directly to the terminal block
- Cable lengths can not be changed, connected or modified.

Resistive values of sensors in dependance on temperature

Temperature ( °C)	Sensor NTC (kΩ)
20	14.7
30	9.8
40	6.6
50	4.6
60	3.2
70	2.3

Tolerance of sensor NTC 12 kΩ is ± 5% by 25 °C/77 °F.

Diagramm of sensor warm up via air

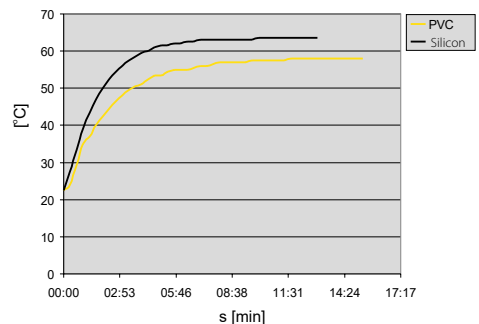

PVC -reaction to water temperature from 22.5 °C to 58 °C.  
 Silicone - reaction to water temperature from 22.5 °C to 63.5 °C.

Design and dimensions

TC

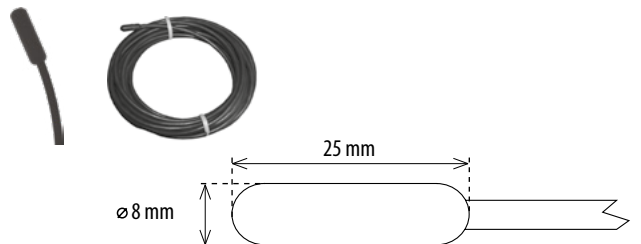

TZ

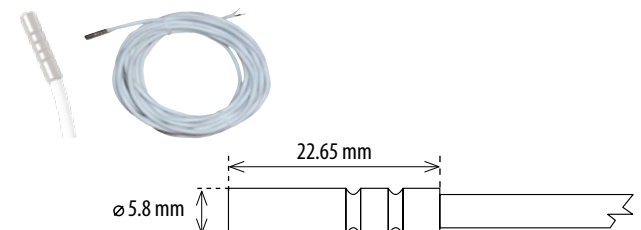

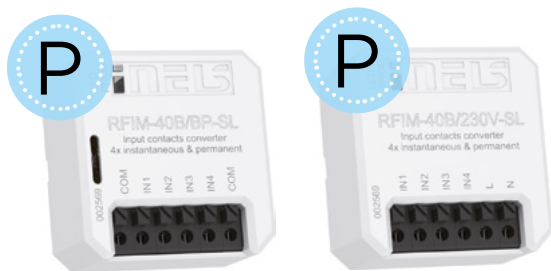

EAN code:  
RFIM-40B/BP-SL: 8595188184069

RFIM-40B/230-SL: 8595188184076

Technical parameters	RFIM-40B/BP-SL	RFIM-40B/230-SL
Supply voltage:	1x 3 V battery CR 123A	230 V AC
Battery life:	8 years based of frequency use	
Indications/transfer function:	red LED	
Number of inputs:	4	4
Supply voltage tolerance:	+10 %; -15 %	
<b>Control</b>		
Communication protocol:	RFIO2	
Frequency:	866–922 MHz (for more information see p. 77)	
Repeater function:	no	
Signal transmission method:	unidirectionally addressed message	
Range:	in open space up to 200 m	
<b>Other data</b>		
Operating temperature:	-10 to +50 °C	
Operating position:	any	
Line resistance between terminals		
- for closed button:	< 300 Ω	
- for open contact:	> 10 kΩ	
Mounting:	free at lead-in wires	
Protection:	IP40	
Surge category:	III.	
Contamination degree:	2	
Connection:	screwless terminals	
Dimensions:	43 x 44 x 22 mm	
Weight:	37 g	25 g
Contact voltage:	3 V	230 VA
Length of cable to contact:	max. 5 m	max. 100 m
		of parallel lines
Related standards:	EN 60730, EN 63044, EN 300 220, EN 301 489	

- **RFIM-40B / BP-SL:** the wireless contact converter changes the wired button / switch to wireless.
  - 4 inputs allow to control 4 devices independently,
  - battery supply (3 V battery CR123A - included in the package) with a lifespan of about 8 years according to the frequency of use,
  - the contact can be permanently closed.
- **RFIM-40B / 230-SL:** the contact converter changes the button / switch with local mains supply to wireless.
  - 4 inputs allow to control 4 devices independently,
  - mains supply, the inputs respond to the supply of mains supply
- It can be used to transmit contact closing information (detector, buttons, technology, logic output).
- When the button is pressed, it sends the set command (ON / OFF, dimming, time off / on, pull / pull).
- Ability to set scenes where you control multiple iNELS Wireless components with a single press.
- Range up to 200 m (outdoors), in case of insufficient signal between the controller and the component, use the RFRP-20N signal repeater or elements with the RFIO2 protocol that support this function.
- The BOX version offers mounting directly in the installation box under the button / switch.
- Attention: The controller is paired with the elements using the pairing button. Ord. codes for controllers with pairing button: RFIM-40B/BP-SL Order No.: 8406, RFIM-40B/230-SL Order No.: 8407, see Pairing controllers on p. 77.

#### Device description

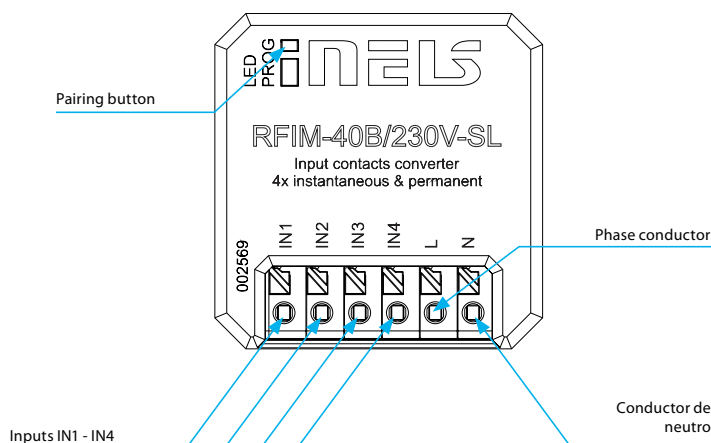
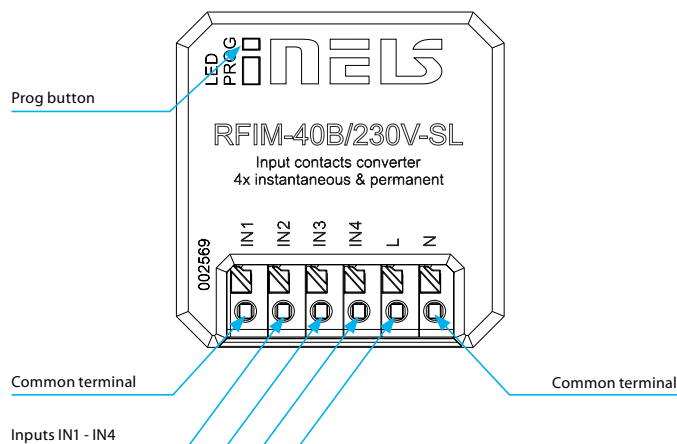

#### Connection

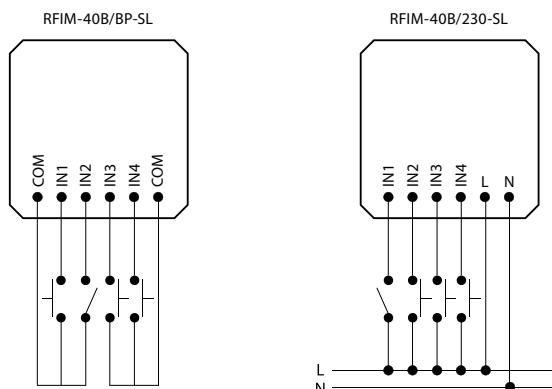





EAN code:  
RFSG-1M: 8595188142847

Technical parameters		RFSG-1M
Supply voltage:		110–230 V AC
Supply voltage frequency:		50–60 Hz
Apparent input:		2 VA
Dissipated power:		0.2 W
Supply voltage tolerance:		+10 %/-25 %
Power supply indication:		green LED
Input		
Control voltage:		AC 12–230 V/DC 12–230 V
Control input power:		AC 0.025 VA/DC 0.1 W
Control terminals:		S–S
The length of control impulse:		min. 25 ms (max. unlimited)
Transmission indication/function:		red LED
Control		
Communication protocol:		RFIO
Frequency:		866–922 MHz (for more information see p. 77)
Repeater function:		no
Signal transmission method:		unidirectionally addressed message
Range:		in open space up to 160 m
Minimum control distance:		20 mm
Wireless antenna:		AN-I included (SMA connector)*
Other data		
Operating temperature:		-15 to +50 °C
Operating position:		any
Mounting:		DIN rail support EN 60715
Protection:		IP20 from the front panel
Overvoltage category:		III.
Contamination degree:		2
Connecting conductor cross-section: (mm <sup>2</sup> ):		max. 1x 2.5, max. 2x 1.5/ with a hollow max. 1x 2.5
Dimensions:		90 x 17.6 x 64 mm
Weight:		62 g
Related standards:		EN 60730, EN 63044, EN 300 220, EN 301 489

\* Max Tightening Torque for antenna connector is 0.56 Nm.

- This wireless contact converter is especially appropriate for wireless transmission of information on switching HDO.
- Thanks to the permanent power supply, it can also be used for partial transmission of information for control of an appliance or device.
- After leading in power to the “S” terminals, it periodically transmits the command switch on in an interval of 2 min. When disconnecting the power supply, immediately switch off.
- The button TEST on the controller is used to assign to a switching unit.
- The package includes an internal antenna AN-I, in case of locating the converter in a metal switchboard, you can use the external antenna AN-E for better signal reception, see accessories on page 66.
- Range up to 160 m (in open space), if the signal is insufficient between the controller and unit, use the signal repeater RFRP-20N.
- 1-MODULE design of the unit with mounting into switchboard.
- The product is suitable for the transmission of control signals within photovoltaic electrical installations.
- Attention: The controller is paired with the elements using the pairing button. Ord. codes for controllers with pairing button: RFSG-1M Order No.: 8240, see Pairing controllers on p. 77.

Device description

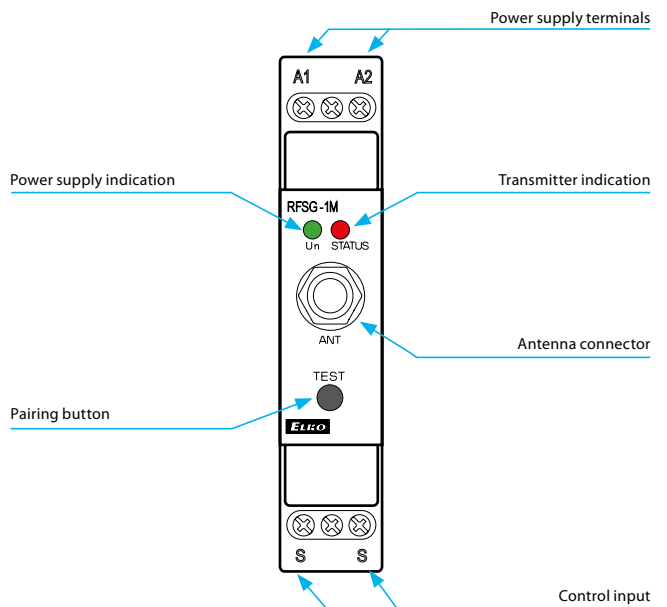

Connection

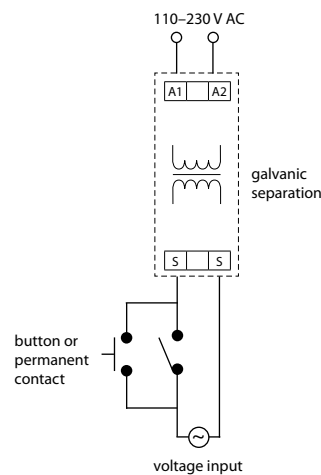



Technical parameters		RFTM-1
Power supply:	2x 1.5 AAA batteries	
Battery Life:	Appr. 2 years, (depending on the type of sensor, frequency of transmissions and pulses)	
Indication		
Setting mode:	Green LED flashes - active Red LED - flashes during impulse sensor registration	
Communications Test	Green LED - communication OK	
- Wireless STATUS:	Red LED - communication ERR	
Normal operation:	no indication	
Control		
Manual control:	button SET	
Sensor Selection:	rotary potentiometer	
Supported sensors	LS (LED sensor)	
(not included in the package):	MS, WS (magnetic sensor) S0 (Contact, open collector, reed magnetic contacts)	
Output		
Communication protocol:	RFIO	
Frequency	866–922 MHz (for more information see p. 77)	
Range:	in open space up to 100 m	
Other data		
Working temperature:	-20 to +50 °C *	
Storage temperature:	-30 to +70°C	
Operating position:	any	
Protection:	IP65	
Cross-section of connecting wires:	max. 0.5 - 1 mm <sup>2</sup>	
Dimension:	72 x 62 x 34 mm	
Weight:	104 g	

\* Pay attention to the operating temperature of batteries.

- The wireless pulse converter detects home energy meters (electric, water, gas) by means of sensors, and sends them to the wireless unit eLAN-RF-103.
- Measured values are displayed in the iNELS application iHC-MAIRF/iHC-MIIRF, in daily, weekly or monthly overview in graphs.
- The sensor is designed for use on existing meters and even without the impulse output "S0" (The gauge must support scan).
- RFTM-1 transfers consumption from meters using sensors - LS (LED sensor), WS (Magnetic sensor for meter), MS (Magnetic sensor) or by impulse output („S0“).
- For each consumption meter, it is necessary to have one pulse converter RFTM-1.
- Battery power (2x 1.5 V AAA batteries - included in package) with average battery life of around 2 years (according to the type of scan, frequency of transmissions and pulses).
- Range up to 100 m (in open space), if the signal between the controller and the user is weak, use the signal repeater RFRP-20N or protocol component RFIO2 that support this feature.
- The increased IP65 protection is appropriate for mounting in risers, switchboards and other demanding environments.

### Device description

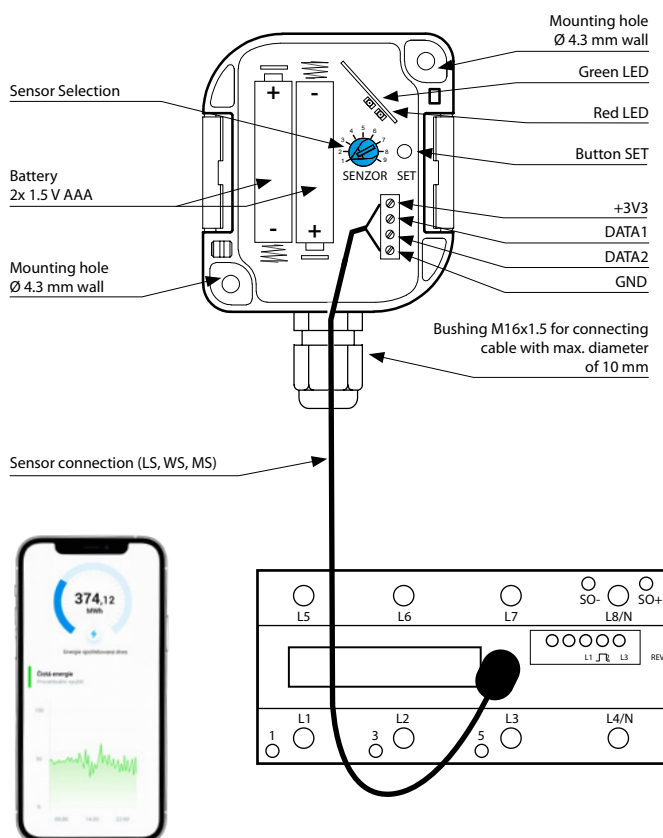



EAN code:  
RFSF-100: 8595188176828

Technical parameters		RFSF-100
<b>Power supply</b>		
Battery power:	2x 1.5 V AAA batteries	
Battery life by frequency 1x 12 hours:	3 years	
<b>Setting</b>		
Alarm Detection:	optical and audible alarm	
Battery status view:	low battery is indicated by 5 flashes every 15 minutes or by display in the system element	
Acoustic signal:	greater than 45 dB/1m	
<b>Detection</b>		
Sensor:	contacts for flooding	
Detection principle:	contact between the sensor sensed liquid	
Response Time:	2 s after connecting the scanning contacts	
Measurement accuracy:	99.8 %	
Sensitivity:	in the range 0–170 kΩ	
<b>Control</b>		
Communication protocol:	RFIO	
Frequency:	866–922 MHz (for more information see p. 77)	
Repeater function:	no	
Signal transmission method:	unidirectionally addressed message	
Range:	in open space up to 160 m	
<b>Other parameters</b>		
Working temperature:	0 to +50 °C (Pay attention to the operating temperature of batteries)	
Storage temperature:	-20 to +60 °C	
Operation position:	capture contacts for flooding downwards	
Mounting:	loose	
Protection degree:	IP62	
Dimension:	Ø 89 x 23 mm	
Weight:	92 g	

- The flood detector is used to detect water leakage - the activation occurs the moment the flooding of the contacts located on the underside of the detector occurs.
- Upon detecting water, the flood detector immediately sends a signal to the switched unit, which further switches on a pump or closes a pipe valve.
- Flood detection is signalled by optical and acoustic signalling.
- Range up to 160 m (in open space); if the signal is insufficient between the controller and unit, use the signal repeater RFRP-20N or protocol component RFIO2 that support this feature.

**Description**

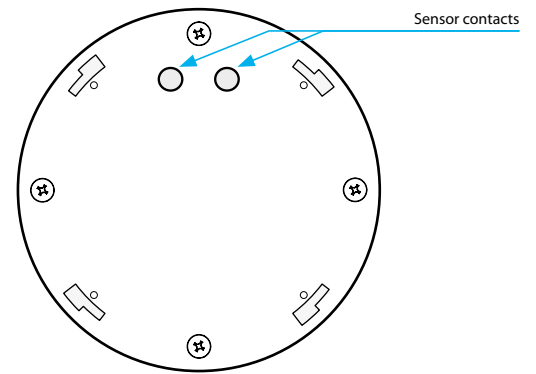

**Function**

When the scanning contact is connected, the detector sends the message and starts alarm.

**Conductivity of liquids**

Liquids suitable for detection		Inadmissible liquids
Type of liquid	Resistivity [Ωcm]*	
Drinking water	5–10 kΩ	Demineralised water
Well water	2–5 kΩ	Deionised water
River water	2–15 kΩ	Bourbon
Rain water	15–25 kΩ	Gasoline
Waste water	0.5–2 kΩ	Oil
Seawater	~0.03 kΩ	Liquid gases
Salt water	~2.2 kΩ	Paraffin
Natural/hard water	~5 kΩ	Ethylene glycol
Chlorinated water	~5 kΩ	Paints
Condensed water	~18 kΩ	High alcohol-content liquids
Milk	~1 kΩ	
Milk serum	~1 kΩ	
Fruit juices	~1 kΩ	
Vegetable Juices	~1 kΩ	
Broths	~1 kΩ	
Wine	~2.2 kΩ	
Beer	~2.2 kΩ	
Coffee	~2.2 kΩ	
Soap toam	~18 kΩ	

\* Resistivity characterizes the resistive properties of materials which conduct electric current.



EAN code:  
RFSOU-1: 8595188147071

Technical parameters	RFSOU-1
Power supply:	2 x 1.5 AAA batteries
Battery Life:	Appr. 2 years, according to the number of controlled units
<b>Setting the range of light levels</b>	
Function ☾ (twilight switch)	
- Range 1:	1 to 10 lx
- Range 2:	10 to 100 lx
- Range 3:	100 to 1.000 lx
Function ☀ (light switch)	
- Range 1:	100 to 1 000 lx
- Range 2:	1 000 to 10 000 lx
- Range 3:	10 000 to 100 000 lx
Function setting:	rotary switch
The level of lighting gently:	0.1 to 1 x range
Fine adjustment of lighting levels:	potentiometer
The time delay t:	0/1 min./2 min.
Setting the delay time t:	rotary switch
<b>Control</b>	
Communication protocol:	RFIO
Frequency:	866–922 MHz (for more information see p. 77)
Repeater function:	no
Range:	in open space up to 160 m
<b>Other data</b>	
Working temperature:	-20 to +50 °C
Storage temperature:	-30 to +70 °C
Operating position:	sensor side down
Protection:	IP65
Degree of pollution:	2
Dimension:	72 x 62 x 34 mm
Weight:	104 g
Standards:	EN 60730, EN 63044, EN 300 220, EN 301 489

- The twilight switch measures the light intensity and based on a set value, it sends the command to switch on the lights or pull the blinds up or down.
- It can be combined with multifunctional switching units and blind switches.
- Integrated sensor for measuring illumination, settable in 3 ranges 1-100,000 lx.
- Selection of function:
  - a) twilight switch – automatically switches on upon a decrease in ambient light intensity, switches off upon an increase (appropriate for garden lights, advertisements, public lighting, etc.).
  - b) light switch – automatically switches on upon an increase in ambient light intensity, switches off upon a decrease (appropriate for offices, restaurants, rooms, etc.).
- Settable delay up to 2 minutes to eliminate unwanted switching caused by surrounding influences.
- The twilight switch may control up to 32 units in the installation.
- The programming button on the regulator is used for:
  - a) setting a function with a switching or blind unit
  - b) ascertaining battery status
  - c) ascertaining signal quality between the unit and dimmer.
- Battery power (2x 1.5 V AAA batteries - included in supply) with battery life of around 2 years based on the number of controlled units.
- Range up to 160 m (in open space), if the signal is insufficient between the controller and unit, use the signal repeater RFRP-20N or protocol component RFIO2 that support this feature.

### Device description

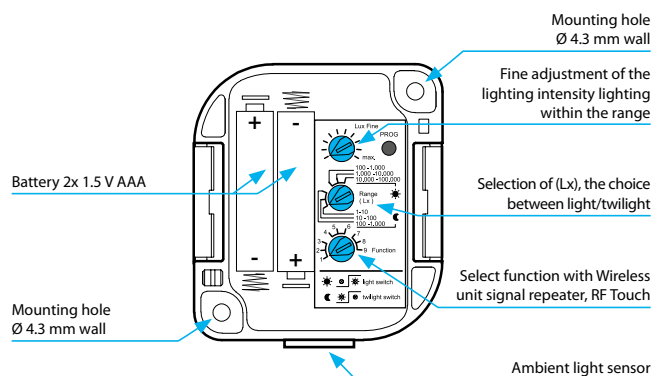



EAN code:  
RFWD-100: 8595188150279

Technical parameters		RFWD-100
Power supply:		1x 3 V CR 2032 battery
Drained battery indicator:		yes
<b>Control</b>		
Communication protocol:		RFIO
Frequency:		866–922 MHz (for more information see p. 77)
Repeater function:		no
<b>Other data</b>		
Working temperature:		-10 to +50 °C
Protection:		IP20
Colour:		white
Dimension:		25 x 75 x 16 mm
Magnet dimension:		15 x 75 x 14 mm

- The Window/Door detector is used to detect opening where activation occurs when the magnet and the sensor become separated.
- Use:
  - in combination with the switching unit for automatic light control (cellar, garage, etc.).
  - by means of the Smart RF gate, detection can be displayed on your smart phone in the form of a notification; alarms are stored in the history, which is visualized in the iNELS application.
- Anti-tamper function: an alarm is triggered if there is an unauthorized interference to detector.
- Power supply: 1x 3 V CR 2032 battery, the battery life is around 1 year, thanks to the ability to turn off the LED indicator it is possible to extend up to 3 years.
- “Low Battery” Alerts on Your iNELS App.
- The detectors are compatible with switching components marked with the RFIO2 communication protocol and the eLAN-RF system components.

RFWD-100/MT | Window/Door detector MATTER



EAN code:  
RFMD-100: 8595188189533

Technical parameters		RFWD-100/MT
Power supply:		1x 3 V CR 2032 battery
Battery life:		up to 1 year, according to the number of activations
Drained battery indicator:		yes
<b>Control</b>		
Application protocol:		Matter
Communication protocol:		THREAD
Frequency:		2,4 GHz
Detection angle:		105°
<b>Other data</b>		
Working temperature:		-10 to +50 °C
Protection:		IP20
Colour:		white
Dimension:		25 x 75 x 16 mm
Magnet dimension:		15 x 75 x 14 mm

- The Window/Door detector is used to detect opening where activation occurs when the magnet and the sensor become separated
- It communicates on the Thread protocol that guarantees compatibility with other products with the Matter support
- Use:
  - in combination with the switching unit for automatic light control (cellar, garage, etc.)
  - by means of the Matter application, detection can be displayed on your smart phone in the form of a notification
- Power supply: 1x 3 V CR 2032 battery, the battery life is around 1 year
- Display of battery percentage in the form of Matter Application
- The pairing of the detector with the element is done via a border router supporting Matter and via a Matter-enabled application. Border router means a device such as a HomePod Mini, Google Nest Hub or Samsung SmartThings Station.



EAN code:  
RFMD-100: 8595188150293

Technical parameters		RFMD-100
Power supply:	2x 1.5 V AA batteries	
Battery life:	up to 1 year, according to the number of activations	
Drained battery indicator:	yes	
Control		
Communication protocol:	RFIO	
Frequency:	866–922 MHz (for more information see p. 77)	
Repeater function:	no	
Detection angle:	105°	
Detection distance:	max. 12 m	
Recommended working height:	max. 2.4 m	
Other data		
Working temperature:	-10 to +50 °C	
Protection:	IP20	
Colour:	white	
Dimension:	46 x 105 x 43 mm	
Weight:	57 g	

- The motion detector PIR is used to detect persons moving inside the building interior.
- Use:
  - in combination with a switching unit for automatic control of lighting or triggering an alarm.
  - by means of the Smart RF gate, detection can be displayed on your smart phone in the form of a notification; alarms are stored in the history, which is visualized in the iNELS application.
- Sensitivity settings of the PIR detector for eliminating unwanted triggering.
- Integrated lighting sensor, thanks to which you can set the detector's reaction time.
- Option of activation/deactivation of the LED indicator on the detector cover.
- Anti-tamper function: an alarm is triggered if there is an unauthorized interference to detector.
- Power supply: 2x 1.5 V AA batteries, the battery life is around 1 year.
- "Low Battery" Alerts by double LED flashing or on iHC App.
- The detectors are compatible with switching components marked with the RFIO2 communication protocol and the eLAN-Wireless system components.

#### Detection field

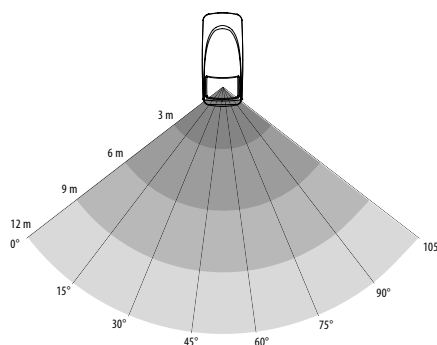



EAN code:  
RFMD-200: 8595188189194

Technical parameters	RFMD-200
Power supply:	2x 1.5 V AA batteries
Battery life:	up to 1 year, according to the number of activations
Drained battery indicator:	yes
<b>Control</b>	
Communication protocol:	RFIO
Frequency:	866-922 MHz (for more information see p. 77)
Repeater function:	no
Detection angle:	110°
Detection distance:	max. 9.5 m
Recommended working height:	max. 2.5 m
<b>Other data</b>	
Working temperature:	-10 to +50 °C
Protection:	IP20
Colour:	white
Dimension:	46 x 105 x 43 mm
Weight:	113 g

- The motion detector PIR is used to detect presence persons moving inside the building interior.
- Use:
  - in combination with a switching unit for automatic control of lighting or triggering an alarm.
  - by means of the Smart RF gate, detection can be displayed on your smart phone in the form of a notification; alarms are stored in the history, which is visualized in the iNELS application.
- In combination with hotel elements (HRESK) it can serve as a room occupancy sensor
- Sensitivity settings of the PIR detector for eliminating unwanted triggering.
- Option of activation/deactivation of the LED indicator on the detector cover.
- Power supply: 2x 1.5 V AA batteries, the battery life is around 1 year.
- "Low Battery" Alerts by double LED flashing or on iHC App.
- The detectors are compatible with switching components marked with the RFIO2 communication protocol and the eLAN-Wireless system components.

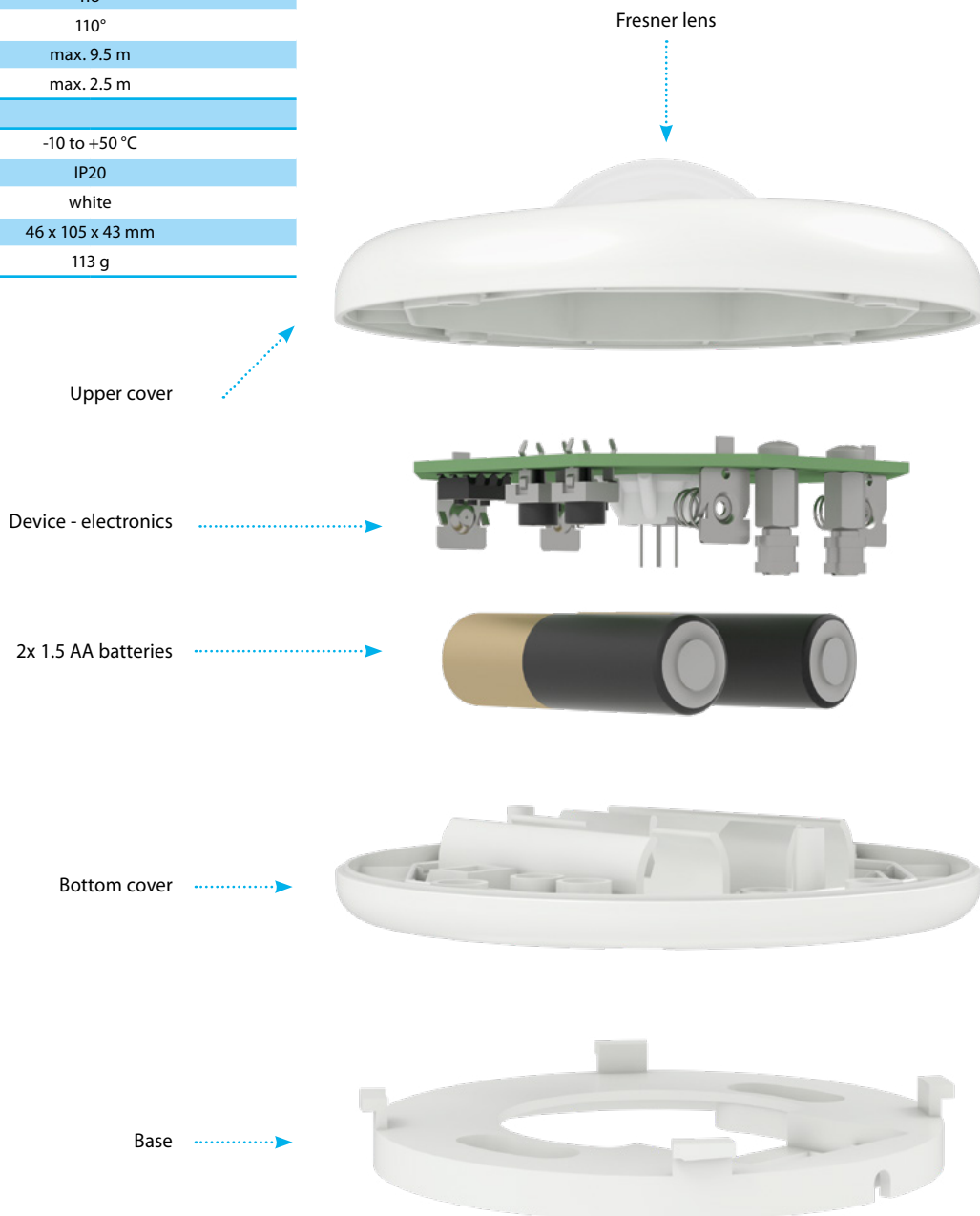



EAN code:  
8595188183994

Technical parameters		RFSLT-S3
Power supply:	Battery (lithium cell, 3V6-AA-LS)	
Input	Pressure sensor with digital connection	
Probe cable length:	standard 3m	
Measuring range:	standard 0-3m H <sub>2</sub> O (other by agreement)	
Measurement frequency:	1x / min	

Output	
Relay:	up to 6 relays
Alarm:	wireless relay
Output update frequency:	1x min (only when changing the level)
Accuracy:	± 0,5%
Time response:	≤ 100ms
long-term stability:	≤ ± 0,2 % span / year under reference conditions
Mechanical stability:	
vibrations	10g, 25 Hz...2 kHz
shocks	100g / 1ms

Electrical resistance	
Short circuit protection:	permanent
Reverse polarity protection:	approx. 1 year (according to ambient temperature cycling)
Electromagnetic compatibility:	radiation and immunity to interference according to EN 61326

Control	
<i>INELS standard</i>	
Communication protocol:	RFIO
Frequency:	866-922 MHz (for more information see p. 77)
Repeater function:	no
Manual control:	application
Range:	in open space up to 200 m
Minimum control distance:	20 m
<i>Bluetooth</i>	
Communication protocol:	Bluetooth Low Energy
Frequency:	2,4GHz
Repeater function:	no
Manual control:	application
Range:	in open space up to 50 m

Other data	
Operating temperature:	-20 to +40 °C
Working position:	any
Mounting:	screws
Protection:	IP65, probe IP68
Recommended power cable:	The sensor including the cable is included in the package
Dimension:	136 x 62 x 34 mm
Weight:	150 g
Standards:	EN 60730, EN 63044, EN 300 220, EN 301 489, EN 300 328

- It measures the level of liquids based on the principle of hydrostatic pressure measurement.
- It consists of a communication unit in a plastic case with IP65 protection placed above the surface and a stainless steel pressure probe connected by a cable lowered to the bottom of the tank.
- The standard length of the probe cable is 3m or 9m.
- The unit communicates wirelessly via the RFIO2 protocol with the devices of the iNELS RF Control system and is powered by a 3V6 lithium battery. The range of the switching actuators from the unit is determined by the building/location, in open space it is normally 200 meters.
- The unit can also communicate with the eLAN-RF-103 gateway, which conveys level information to the iNELS application.
- In the application, it is possible to manage switching actors, edit notifications, continuously monitor the level, pressure, temperature and battery discharge status in the unit.
- The unit itself is set up via the iSonda application from an Android/iOS smartphone via the Bluetooth interface (LowEnergy, 4.1 and higher).

### Function

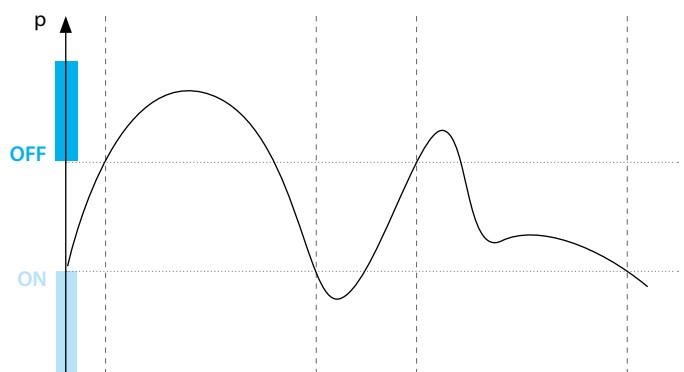
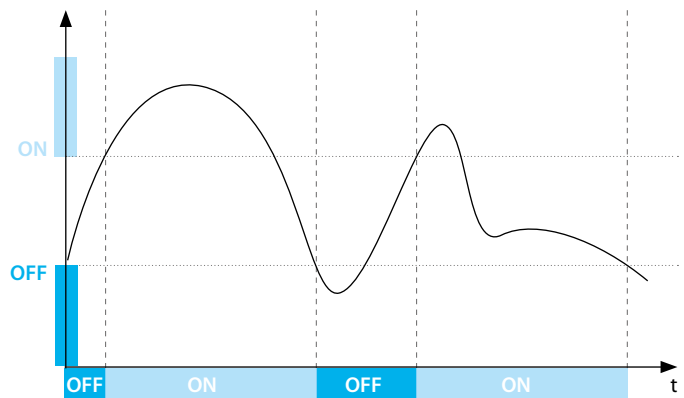

### Materials (in contact with the medium)

Housing:	stainless steel 1.4301 (304)
Seal:	FKM
Membrane:	stainless steel 1.4435 (316 L)
Cable jacket:	PUR



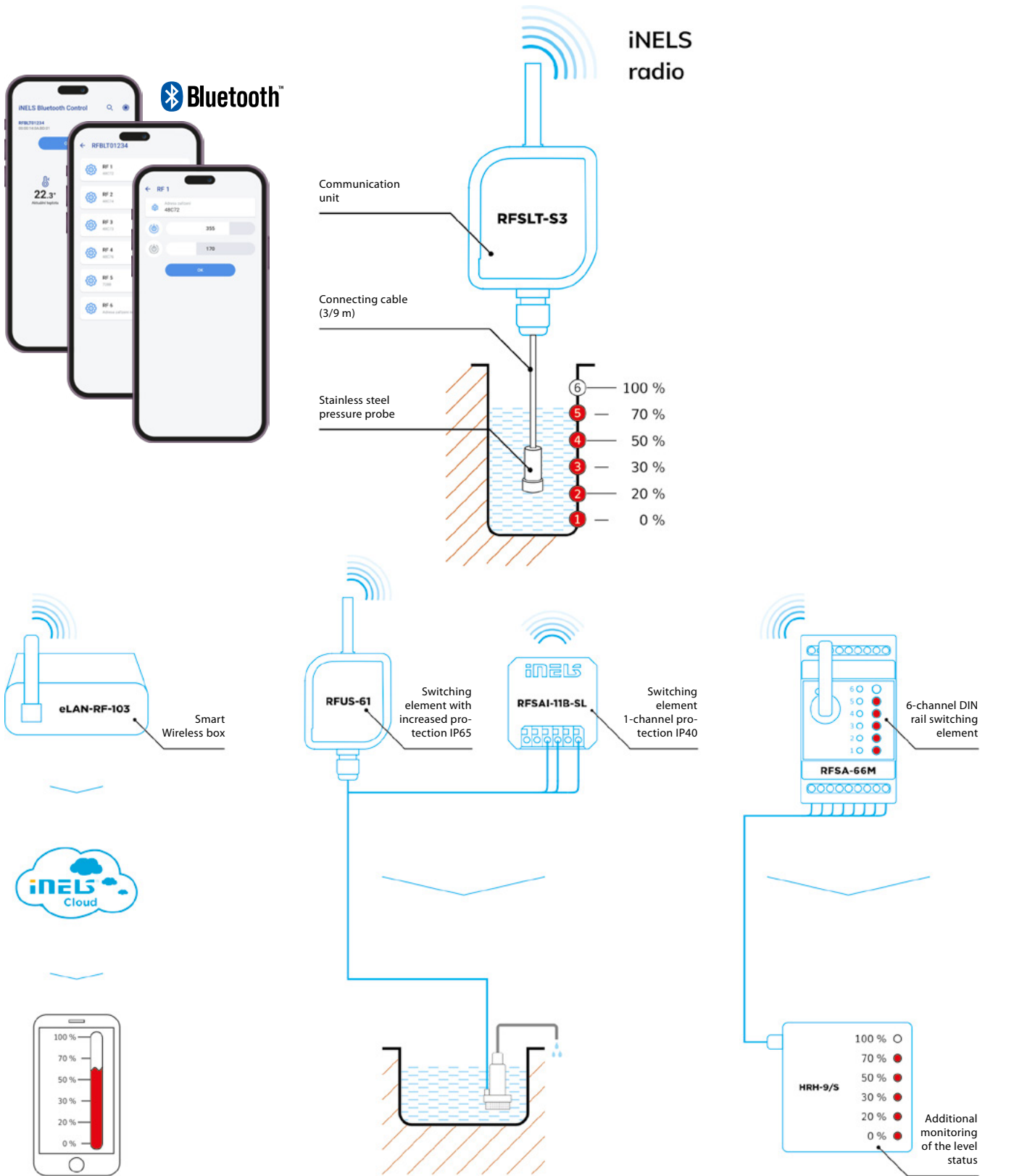

Signaling via the application on the phone

Control of 1 pump: **RFSAI-11B-SL, RFUS-61**  
Control of 2 pumps: **RFS-62B-SL**

Control/signaling, 6x output (eg: MAX / MIN / CRITICAL MAX / CRITICAL MIN)



EAN code:  
RF TOUCH-2/BE: 8595188182669  
RF TOUCH-2/BR: 8595188189743

Technical parameters	RF Touch-2/BE	RF Touch-2/BR
<b>Display</b>		
Type:	color TFT LCD 4"	
Distinction:	480 x 480 pixels	
Aspect Ratio:	72 x 72 mm	
Visible area:	active (white LED)	
Backlight:	capacitive	
<b>Power supply</b>		
USB-C	5V	5V
Passive PoE:	24V	—
Terminal plate:	(10-30V DC)	
Power consumption:	max. 3 W	
<b>Communication</b>		
<b>Radio</b>		
Communication protocol:	RFIO2	
Frequency:	866–922 MHz (for more information see p.69)	
Range:	open space up to 200 m	
Min. distance RF Touch component:	1 m	
<b>WiFi</b>		
Protocols:	802.11 b/g/n (802.11n to 150 Mbps) A-MPDU and A-MSDU	
Frequency:	2.4 GHz	
<b>LAN</b>		
Ethernet:	100 Mbit/s	
<b>Sensors and notifications</b>		
Temperature sensor	0-50 °C; 0.2 °C out of range	
Humidity sensor	0-100%; 2% of range (RH)	
Proximity sensor	15cm	
Notification LED	RGB	
<b>Operating conditions</b>		
Operating temperature:	0 to +50 °C	
Storage temperature:	- 20 to +70 °C	
Cover:	IP20	
Surge category:	III.	
Degree of pollution:	2	
Working position:	any	
Installation:	into the installation box	
Dimensions:	86 x 86 x 10 (37)	
Weight (plastic):	120 g	
Related standards:	EN 60730, EN 63044, EN 300 220, EN 301 489, EN 300 328	

- RF Touch-2 touch control unit is a system element used for automatic and manual control of switching, dimming, or blind elements and heating control elements within the iNELS Wireless system.
- The control unit is available in two versions:
  - RF Touch-2/BE – professional version powered via PoE, USB-C, or 10-30V DC screwless terminals and communicating via Wi-Fi and LAN for connection in new home installations, hotels, hospitals, and office buildings
  - RF Touch-2/BR – simpler version with powered via USB-C or 10-30V DC screwless terminals and communicating via Wi-Fi for easy connection in renovated rooms without having to connect to the local network
- Both versions communicate wirelessly with iNELS Wireless units using radio frequency and allow up to 40 wireless element addresses and 30 detectors to be connected in this way.
- RF Touch-2 touch unit also serves as a communication gateway, so besides direct control via the 4" capacitive display, it allows communication with the system via the iNELS app and provides connection to the iNELS Cloud.
- A great advantage of the unit is that it supports the MQTT protocol, thus allowing controlling it via HomeKit, Home Assistant, and other Smart Home and professional BMS integrations.
- RF Touch-2 unit offers a range of automatic functions that can be used even when not connected to a local network, such as controlling heating modes, timers, light scenes, and leaving buttons.
- RF Touch-2 features integrated temperature and humidity sensors for controlling heating modes and a proximity sensor for non-contact lighting of the display.
- Innovative design allows for easy installation in a mounting box

### Device description

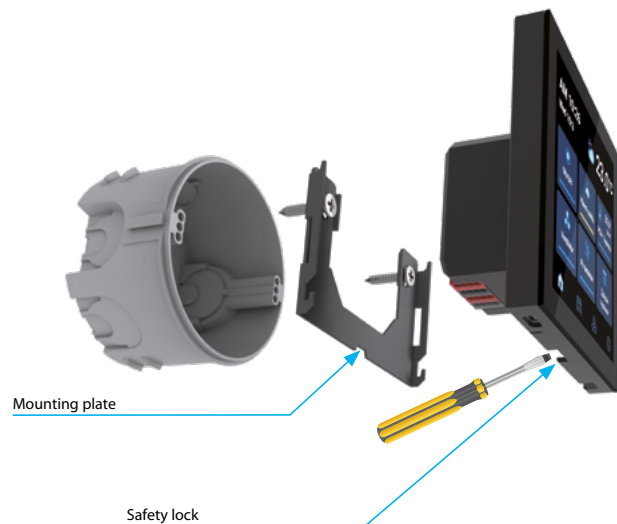
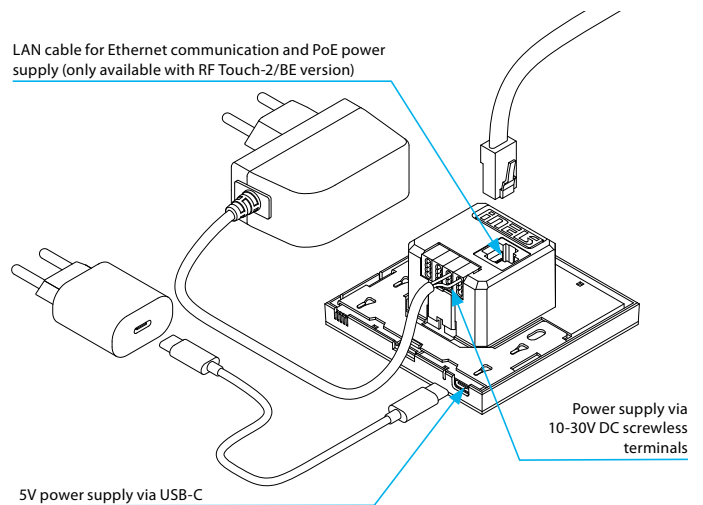

Communication diagram

Communication with RF Touch-2 can be direct (fixed IP) or indirect (via iNELS cloud).



Screen preview

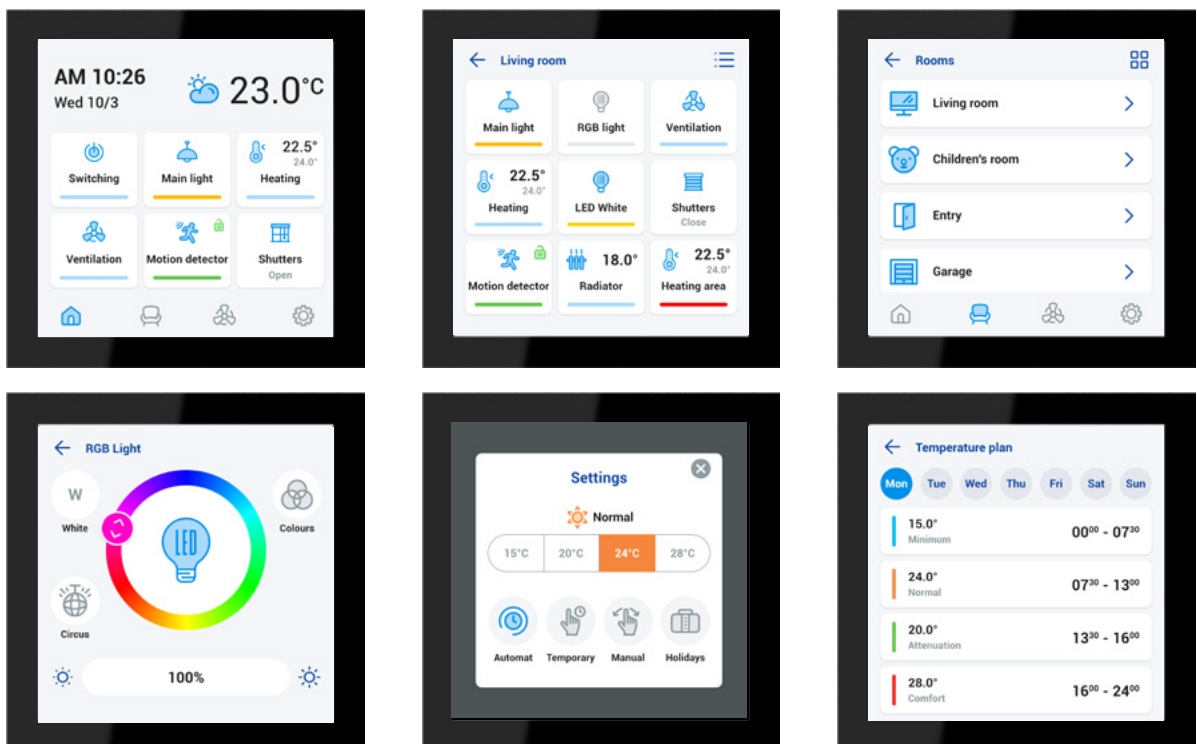



EAN code:  
eLAN-RF-103: 8595188180443

Technical parameters		eLAN-RF-103
<b>Interface Wireless Control</b>		
Communication protocol:	RFIO2	
Broadcasting frequency:	866–922 MHz (for more information see p. 77)	
Signal transfer method:	two-way addressed message	
Output for antenna:	SMA connector*	
Antenna Wireless:	AN-I 1 dB	
Indications Wireless communications:	1x green RF LED	
Range:	in open space up to 100 m	
<b>Interface Ethernet</b>		
ETH operating status indicator:	green LED	
ETH communication indicator:	yellow LED	
Communications interface:	100 Mbps (RJ45)	
Preset IP address:	DHCP	
<b>Power supply</b>		
Supply voltage/current:	5 V DC/0.5 A	
Power source:	110–230 V AC/5 V DC–2 A (connector USB-C)	
<b>Button RESET</b>		
- short press:	restart the device	
- press > 5 s	reset network settings	
- press > 10 s:	reset to factory settings	
<b>Indication LED STATUS</b>		
- green:	normal mode	
- red:	error condition	
- orange:	initialization/start	
<b>Other data</b>		
Operating temperature:	-20 to +50 °C	
Storage temperature:	-25 to +70 °C	
Protection:	IP20	
Contamination degree:	2	
Working position:	any	
Dimensions:	90 x 52 x 65 mm	
Weight:	136 g	

\* Max Tightening Torque for antenna connector is 0.56 Nm.

- The Smart Wireless Box is a gateway between iNELS Wireless elements and applications for smartphones, tablets, watches, televisions, voice assistants (Google Home & Alexa) and other third-party devices.
- It is produced in two versions:
  - a) eLAN-RF-103: LAN communication
- It communicates from up to 70 iNELS Wireless elements, processes set programs for automatic control.
- Thanks to two-way communication, it displays the current status of individual elements.
- Powered by 5 V DC/2 A adapter, USB-C connector (included).
- Configuration is done via the iHC application.
- The package includes an internal antenna AN-I, in case the Smart Wireless gate is located in a metal switchboard, you can use the external antenna AN-E for better signal reception, see accessories on p. 75. For the eLAN-RF-Wi-103 version.
- Supports the MQTT protocol, which enables two-way communication between the eLAN-RF-103 and therefore also with the entire iNELS Wireless system with platforms such as Home Assistant, HomeKit and other Smart Home and building management systems.

**Device description**

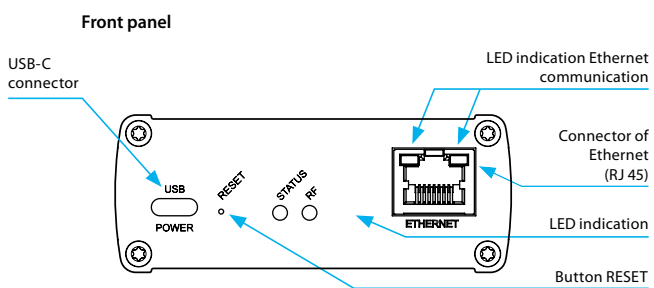

**Back panel**

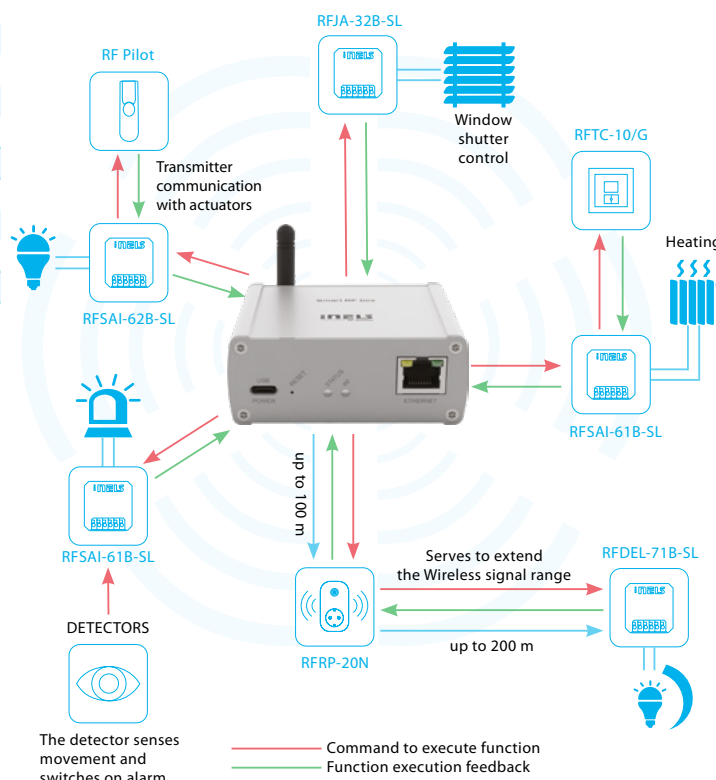
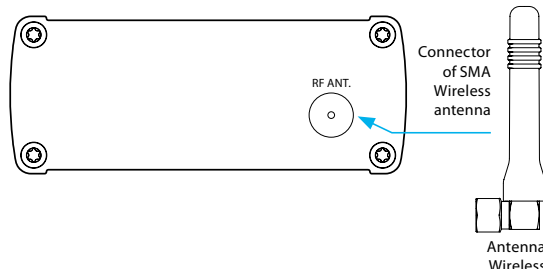



- The signal repeater is used to increase the range between the controller and the device by up to 200 meters.
- It is designed for signal transmission up to 20 components.
- Indications:
  - green LED - supply voltage,
  - red LED - active status (receiving and transmitting Wireless signal).
- Programming is done with the key.
- Thanks to the socket design, installation is simple by plugging it directly into the existing socket, the function of the through socket will be retained.

EAN code:  
 RFRP-20NN/Schuko: 8595188145473 RFRP-20NN/British: 8595188145480  
 RFRP-20NN/French: 8595188145107

Technical parameters		RFRP-20N/230V
Supply voltage:	230V	
Supply voltage frequency:	50-60 Hz	
Apparent input:	7 VA / $\cos \varphi = 0.1$	
Dissipated power:	0.7 W	
Supply voltage tolerance:	+10%/-15%	
Control		
Communication protocol:	RFIO2	
Frequency:	866-922 MHz (for more information see p. 77)	
Range:	in open space up to 200 m	
Minimum control distance:	20 mm	
Programming:	button - green LED/red LED	
Other data		
Operating temperature:	-20 to +55 °C	
Storage temperature:	-30 to +70 °C	
Mounting:	plug into a socket	
Protection:	IP20 Device	
Dimensions:	63 x 110 x 74 mm	
Weight:	115 g	
Related standards:	EN 60730, EN 63044, EN 300 220, EN 301 489	

Produced in 3 designs of sockets/plugs:



Signal transmission and extension for up to 20 components.

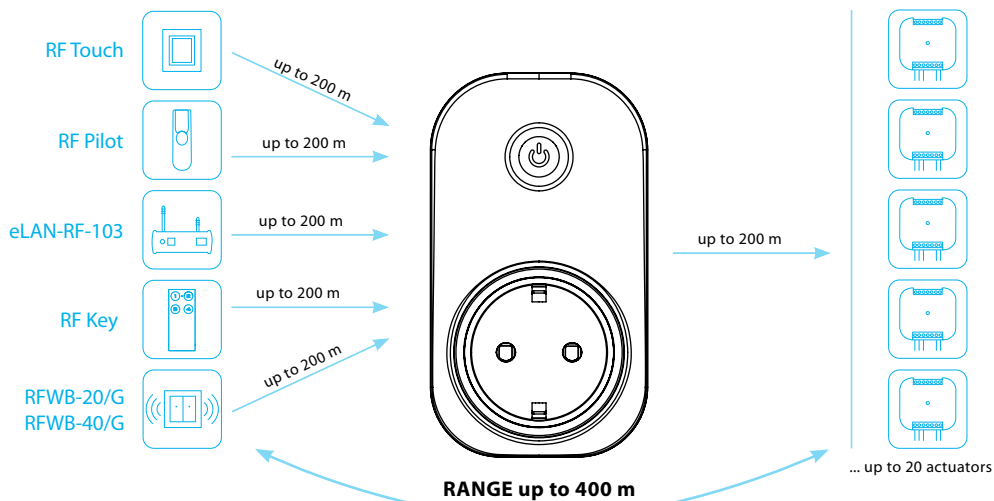

Lined writing area with horizontal blue lines for text entry.

# Hotel Room Energy Saving Kit (HRESK)

Cost savings, increased comfort,  
introduction of automation into a hotel room

hresk

N



RFGS-30/SW

(WHITE glass, SHARP edges)

Technical parameters	RFGS-30/S
Supply voltage:	230 V AC / 50-60 Hz or 24 V AC / DC
Apparent/loss power input:	1.1 VA / 0.8 W
Supply voltage tolerance:	±10 %
<b>Output</b>	
Relay:	2x switching / 8 A / 250 V AC1 / 2000 VA
Peak Current:	$I_{peak} < 110A$ 300us / max. input capacitance 125 uF
Contact Life:	mechanical 10 mil. / electrical 100,000 cycles
<b>Control</b>	
Number of Buttons:	1
Communication:	RFIO2
Frequency:	866-922 MHz (more on page 69)
Repeater Function:	yes
Range:	in open areas up to 200 m
<b>Connection</b>	
Terminal block:	screwless - push in
Wire gauge:	0.2 - 1.5 mm <sup>2</sup> solid flexible
<b>Other data</b>	
Operating Temperature:	-10 to +50 °C
Storage temperature:	-30 to +70 °C
Enclosure:	front IP60 / rear IP20
Overvoltage Category:	II.
Pollution Degree:	2
Working position:	Any
Installation:	in to the installation box
Dimension:	94 x 94 x 39 mm
Weight:	128 g
EAN for 230 V, WHITE, SHARP:	<b>RFGS-30/SW/230:</b> 8595188189477
EAN for 230 V, BLACK, SHARP:	<b>RFGS-30/SB/230:</b> 8595188189200
EAN for 24 V, WHITE, SHARP:	<b>RFGS-30/SW/24:</b> 8595188191586
EAN for 24 V, BLACK, SHARP:	<b>RFGS-30/SB/24:</b> 8595188191579

Create your glass design here:  
[icons.inels.com](https://icons.inels.com)

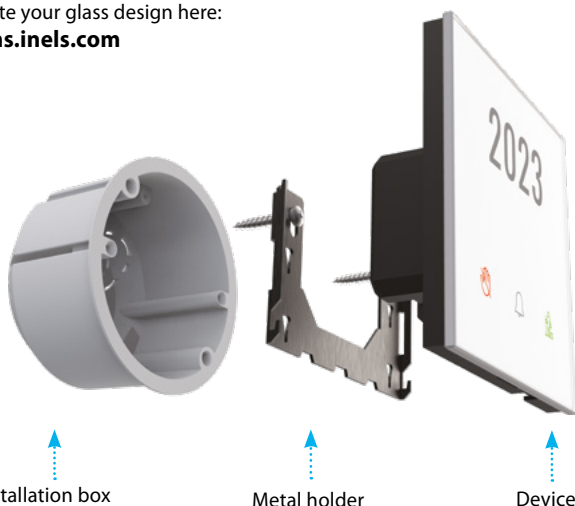

Installation box

Metal holder

Device

- In connection with the RFSW-62/S room unit (or RFTC-3 thermostat), it is used to signal the status of MUR, green LED and DND, red LED
- MUR and DND buttons are interlocked
- Also includes a bell button for controlling a room bell connected to the switched output of this unit or any iNELS Wireless switching element. The button has 2 colors of backlighting (explained below)
- The second switched output of this unit can be used to switch the in front door light and control it from the schedule HRS system, by time or intensity
- The unit can be mounted in an installation box, for example replace a bell button or light switch, only requires a 230V AC power supply. Communication is then wireless
- The unit can be controlled by up to 4 indoor units (RFSW-62/S or RFTC-3)
- Setup and programming is done by a pairing button + signaled by service LEDs
- The unit can be connected to the HRS (Hotel Reception Software) via the eLAN-RF gateway or the RFTC-3 thermostat. The functions can then be controlled from the reception PC console or the iNELS application.
- Standard glass colour white/black, room number and hotel logo can be defined when ordering

### Instrument description

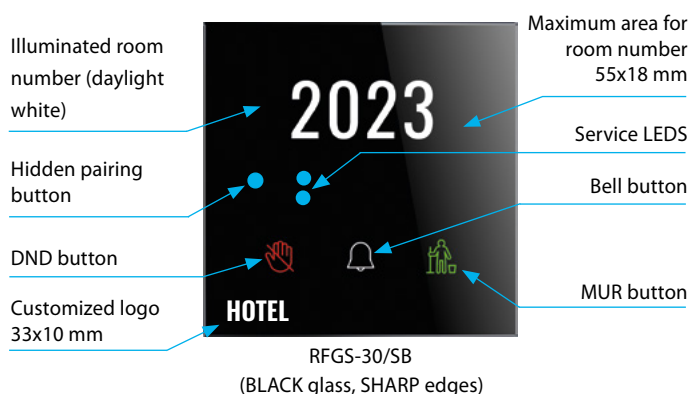

RFGS-30/SB

(BLACK glass, SHARP edges)

### Button legend



### Connection

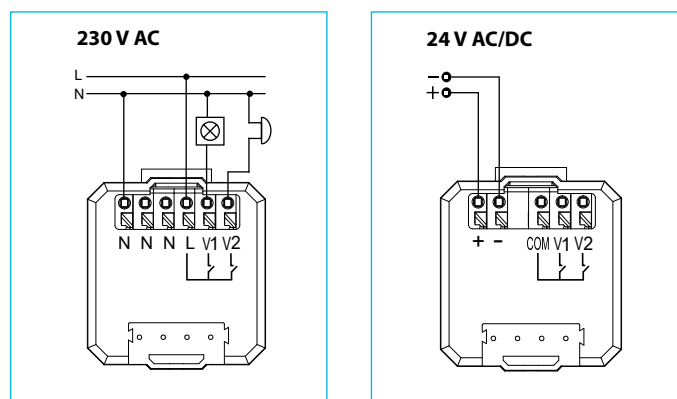

### BELL button backlight meaning

	Colour	Room	Ring
	White	vacant	YES
	Blue	occupied	YES
	Blue+DND active	occupied, but „Do not disturb“	NO



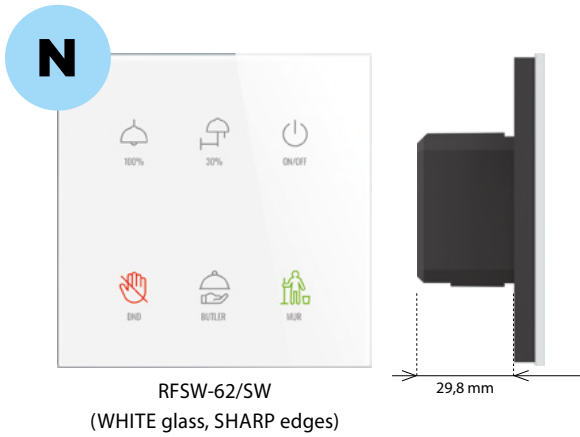

- The wireless glass remote control with symbols is used for:
- Control of iNELS Wireless elements (lighting, blinds or curtains)
- Control of the RFGS-30/S front door unit for MUR/DND
- Switching of 2x light circuits
- MUR (Make Up Room, green LED) and DND (Do not Disturb, red LED) buttons are interlocked
- Butler button calls hotel service (set in HRS)
- the top 3 buttons can be freely defined to control local outputs of the unit or any iNELS Wireless element located in the room (switching, dimming, HVAC, shading)
- Setup and programming is done by pairing button + signaling by service LEDs
- The unit can be connected to the HRS (Hotel Reception Software) system via eLAN-RF gateway or RFTC-3 thermostat. The functions can then be controlled from the reception PC console or the iNELS application of the phone.
- Standard glass colour white/black, buttons and descriptions at the top - or hotel logo when ordering

**Technical parameters**

**RFSW-62/S**

Supply voltage:	230 V AC / 50-60 Hz or 24 V AC / DC
Apparent/loss power input:	1.1 VA / 0.8 W
Supply voltage tolerance:	±10 %

**Output**

Relay:	2x switching / 8 A / 250 V AC1 / 2000 VA
Peak Current:	$I_{peak} < 110A$ 300us / max. input capacitance 125 uF
Contact Life:	mechanical 10 mil. / electrical 100,000 cycles

**Control**

Number of Buttons:	6
Communication:	wireless, iNELS RFIO2 protocol
Frequency:	866-922 MHz (more on page 69)
Repeater Function:	yes
Range:	in open areas up to 200 m

**Connection**

Terminal block:	screwless - push in
Wire gauge:	0.2 - 1.5 mm <sup>2</sup> solid flexible

**Other data**

Operating Temperature:	-10 to +50 °C
Storage temperature:	-30 to +70 °C
Enclosure:	front IP60 / rear IP20
Overvoltage Category:	II.
Pollution Degree:	2
Working position:	Any
Installation:	in to the installation box
Dimension:	94 x 94 x 39 mm
Weight:	131 g

EAN for 230 V, WHITE, SHARP:	<b>RFSW-62/SW/230:</b> 8595188189484
EAN for 230 V, BLACK, SHARP:	<b>RFSW-62/SB/230:</b> 8595188189255
EAN for 24 V, WHITE, SHARP:	<b>RFSW-62/SW/24:</b> 8595188191289
EAN for 24 V, BLACK, SHARP:	<b>RFSW-62/SB/24:</b> 8595188191296

**Device description**

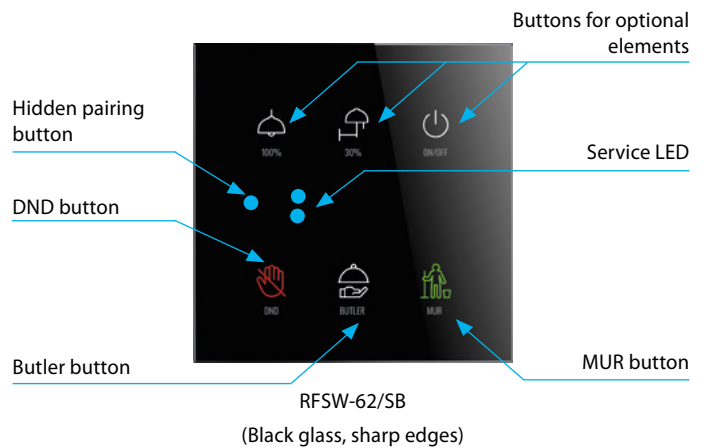

**Legend of buttons**



**Connection**

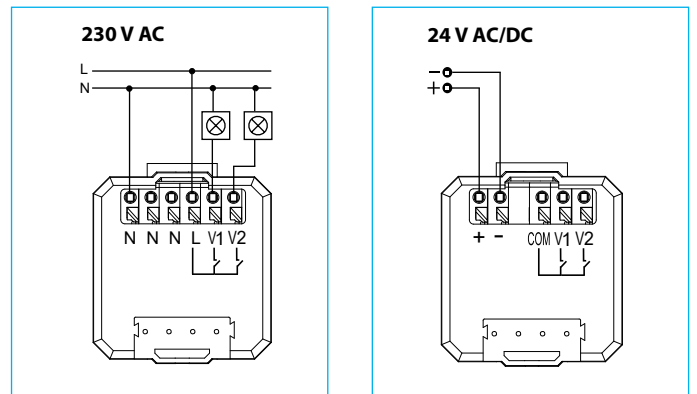

**ZERO CROSS** Friendly Light switching  
the relay contacts switch the phase potential (L) and are equipped with zero cross switching technology

The output contacts (V1, V2) are galvanically isolated from the power supply and share a common COM terminal

Create your glass design here:  
[icons.inels.com](http://icons.inels.com)





EAN code:  
RFTC-150/G: 8595188134576

Technical parameters	RFTC-150/G
Supply voltage:	2x 1.5 V AAA batteries
Battery life:	up to 1 year
Temperature correction:	2 buttons $\vee/\wedge$
Temperature offset:	$\pm 5\text{ }^{\circ}\text{C}$
Display:	LCD, characters
Backlighting:	active 10 s after pressing
Transmission indication/function:	symbols
Temperature measurement input:	1x internal sensor
Temp. measurement range and accuracy:	0 to +55 $^{\circ}\text{C}$ ; 0.3 $^{\circ}\text{C}$ of the range
<b>Control</b>	
Communication protocol:	RFIO
Frequency:	866–922 MHz (for more information see p. 77)
Repeater function:	no
Signal transmission method:	bidirectionally addressed message
Range:	in open space up to 100 m
Minimum control distance:	20 mm
<b>Other data</b>	
Max. number of controlling actuators RFS-A-166M:	1
Program:	weekly
Operating temperature:	0 to +55 $^{\circ}\text{C}$
Operating position:	on the wall
Mounting:	by gluing/screwing
Protection:	IP30
Contamination degree:	2
Dimensions	
- plastic:	85 x 85 x 20 mm
- metal, glass, wood, granite:	94 x 94 x 20 mm
Weight:	66 g (without batteries)
Related standards:	EN 60730, EN 63044, EN 300 220, EN 301 489

- The wireless controller RFTC-150/G measures the room temperature by internal sensor. On the basis of a set program it sends commands to the switching component RFS-A-166M Switching fan coil.
- It is possible to set automatic or manual mode.
- Range of measured temperature 0 to 55  $^{\circ}\text{C}$ .
- The backlit LCD display displays the current and set temperature, status (ON/OFF), battery status, day of the week, current time, etc.
- Battery power (2x 1.5 V AAA batteries - included in supply) with battery life of around 1 year based on frequency of use.
- The flat rear side of the device enables its placement anywhere in the room.
- Components support communication with Wireless detectors.
- Range up to 100 m (in open space), if the signal is insufficient between the controller and unit, use the signal repeater RFRP-20N or protocol component RFIO2 that support this feature.

### Connection

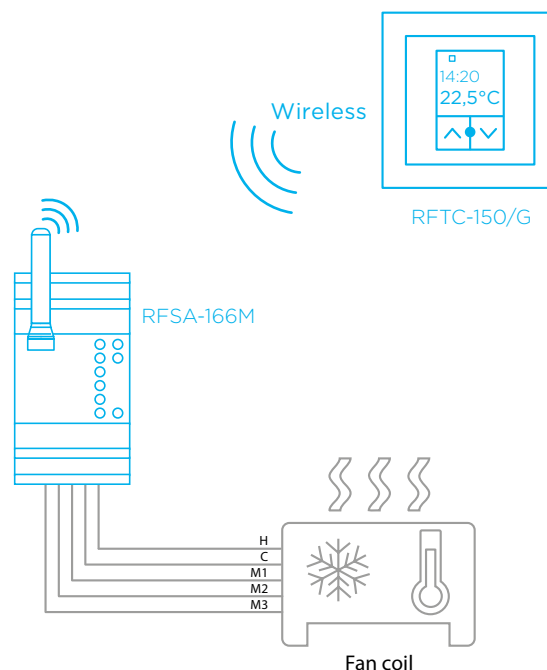



EAN code:  
RFS-266M: 8595188189781

Technical parameters	RFS-266M/230V
Supply voltage:	110–230 V AC
Supply voltage frequency:	50–60 Hz
Apparent input:	min. 2 VA/max. 5 VA
Dissipated power:	min. 0.5 W/max. 2.5 W
Supply voltage tolerance:	+10%/-25 %
<b>Output</b>	
Number of contacts:	5x switching (AgSnO <sub>2</sub> ) / 7 A/AC1 / 10 A/<3 s
Switching power:	1750 VA/AC1
Switching voltage:	250 V AC1
Mech. / el. service life (AC1):	5x 10 <sup>6</sup> / 6x10 <sup>4</sup>
Analog output	2x 0 – 10V (OUT1, OUT2)
<b>Input</b>	
Analog	YES, 2x terminals INT1/GND, INT2/GND / 2x NTC 12 ICR (TC/TZ sensor)
<b>Control</b>	
Communication protocol:	YES, terminals IN1/GND, IN2/GND
Frequency:	866–922 MHz (for more info see p. 77)
Repeater function:	yes
Range:	in open space up to 160 m - RFS-66MI
<b>Other data</b>	
Operating temperature:	-15 °C to +50 °C
Operating position:	any
Mounting:	DIN rail EN 60715
Protection:	IP20 from the front panel
Overvoltage category:	III.
Contamination degree:	2
Connecting conductor cross-section (mm <sup>2</sup> ):	max. 1x 2.5, max. 2x 1.5/ with a hollow max. 1x 2.5
Dimensions:	90 x 52 x 65 mm
Weight:	264 g
Related standards:	EN 60730, EN 63044, EN 300 220, EN 301 489

- Thanks to the 5-channel design of the switching component it can control the heating/cooling mode and 3 speed levels.
- The RFS-266M wireless switch unit can be combined with the RFCT-4.
- The input channels are used to connect to external TC/TZ temperature sensor.
- The product is independently functional when connected to the MODBUS, otherwise it must be connected to control element, e.g. RFCT-4.
- Support for both 2-pipe fancoil and 4-pipe fancoil.
- Fancoil controls the cooling or heating of the room and provides up to 3 speed levels.
- In case of insufficient signal between the controller and the switch unit, use the signal repeater RFRP-20N or elements with RFIO2 protocol that support this function.

Connection for fancoil control

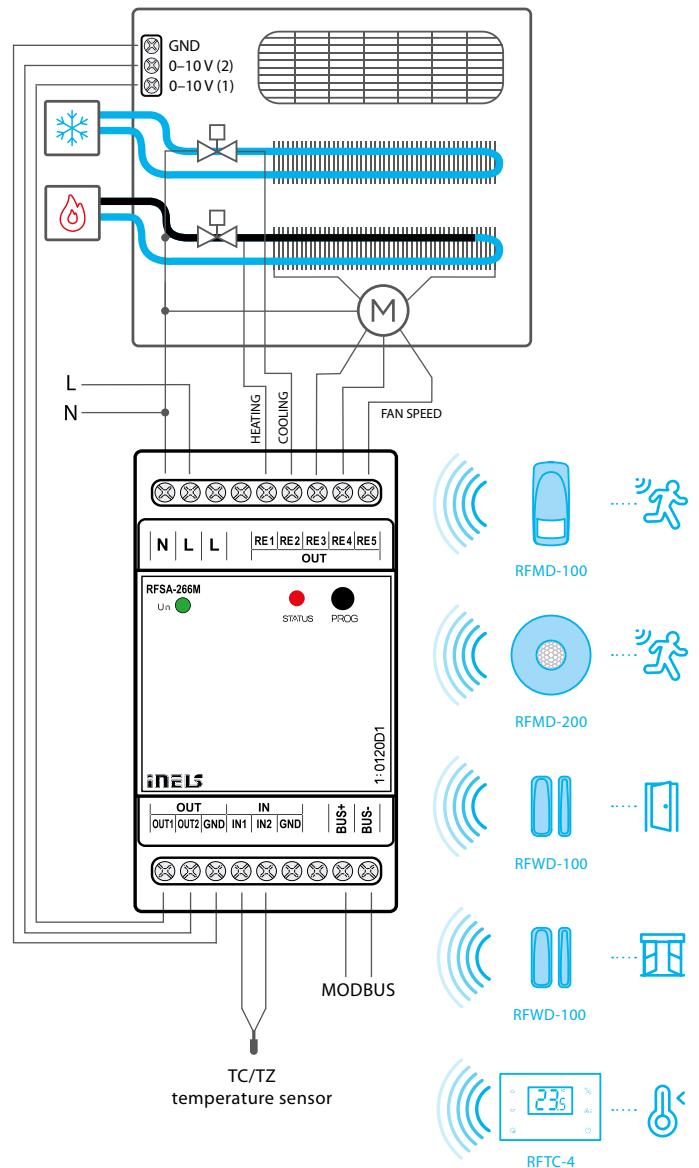



EAN code:  
RFSAI-161B: 8595188149341

### Technical parameters RFSAI-161B/230V RFSAI-161B/120V

Supply voltage:	230 V AC	120 V AC
Supply voltage frequency:	50–60 Hz	60 Hz
Apparent power:	9 VA	9 VA
Dissipated power:	0.7 W	
Supply voltage tolerance:	+10 %; -15 %	

### Output

Number of contacts:	1x switching (AgSnO <sub>2</sub> )
Rated current:	12 A/AC1
Switching power:	3000 VA/AC1, 288 W/DC
Peak current:	30 A, max. 4 s at 10%
Switching voltage:	250 V AC1/24 V DC
Min. switching power DC:	100 mA/10 V
Insulation voltage between outputs and internal circuits:	basic insulation (Cat. III surges by EN 60664-1)

Isolation voltage open contact:	1 kV
Mechanical service life:	3x10 <sup>7</sup>
Electrical service life (AC1):	5x10 <sup>4</sup>
Indication of relay switch:	red LED

### Control

Communication protocol:	RFIO2
Frequency:	866–922 MHz (for more information see p. 77)
Repeater button:	yes
Manual control:	button PROG (ON/OFF)
External button:	cable length max. 12 m $\Delta$ /*
Range:	in open space up to 160 m

### Other data

Open contact voltage external switch:	3 V
Resistor for the management of external switch:	<1 k $\Omega$
Resist. of connection for open contact:	>10 k $\Omega$
Galvanic isolation of input:	no
Operating temperature:	-15 to +50 °C
Storage temperature:	-30 to +70 °C
Working position:	any
Mounting:	free at lead-in wires
Protection:	IP30
Overvoltage category:	III.
Contamination degree:	2
Terminals:	0.5–1 mm <sup>2</sup>
Terminals (CY wire, Cross-section):	2x 0.75 mm <sup>2</sup> , 2x 2.5 mm <sup>2</sup>
Terminal length:	90 mm
Dimensions:	49 x 49 x 21 mm
Weight:	50 g

\* We recommend using a twisted pair cable for this distance.  
Control button input is at the supply voltage potential.

- Switch component with one output channel which is used in combination with detectors for automatic lighting control.
- RFSAI-161B has a pre-set control algorithm (scene) adapted to the requirements of hotel room control, see wiring.
- Each RFSAI-161B can be programmed with 1x RFMD-100, 1x RFWD-100 and 1x wireless controller (RFBW-40/G or RF KEY).
- The terminals on the component give you the opportunity to connect a wired detector or an existing key installation.
- It enables connection of the switched load up to 1x 12 A (3000 VA).
- The programming button on the unit is also used for manual control of the output.
- Range up to 160 m (in open space), if the signal is insufficient between the controller and unit, use the signal repeater RFRP-20N or protocol component RFIO2 that support this feature.

### Device description

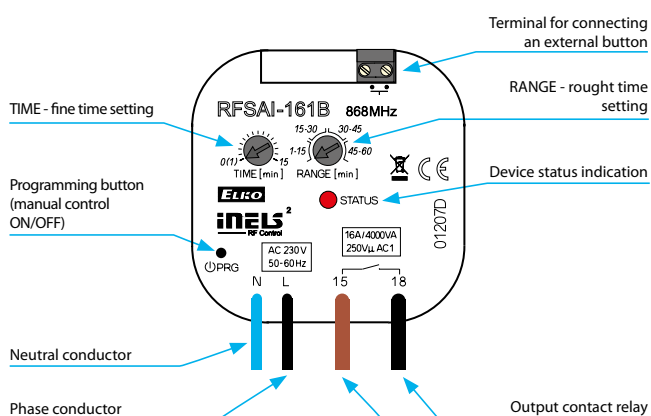

Compatible wireless detectors:  
Movement: RFMD-100  
Door/Window: RFWD-100

### Connection

RFSAI-161B/230V  
RFSAI-161B/120V

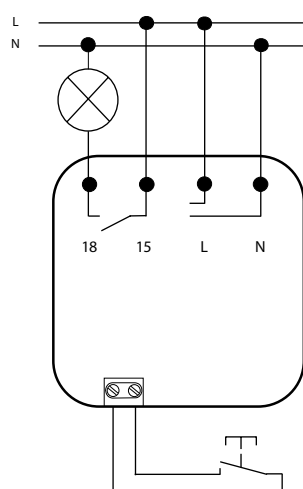

Example

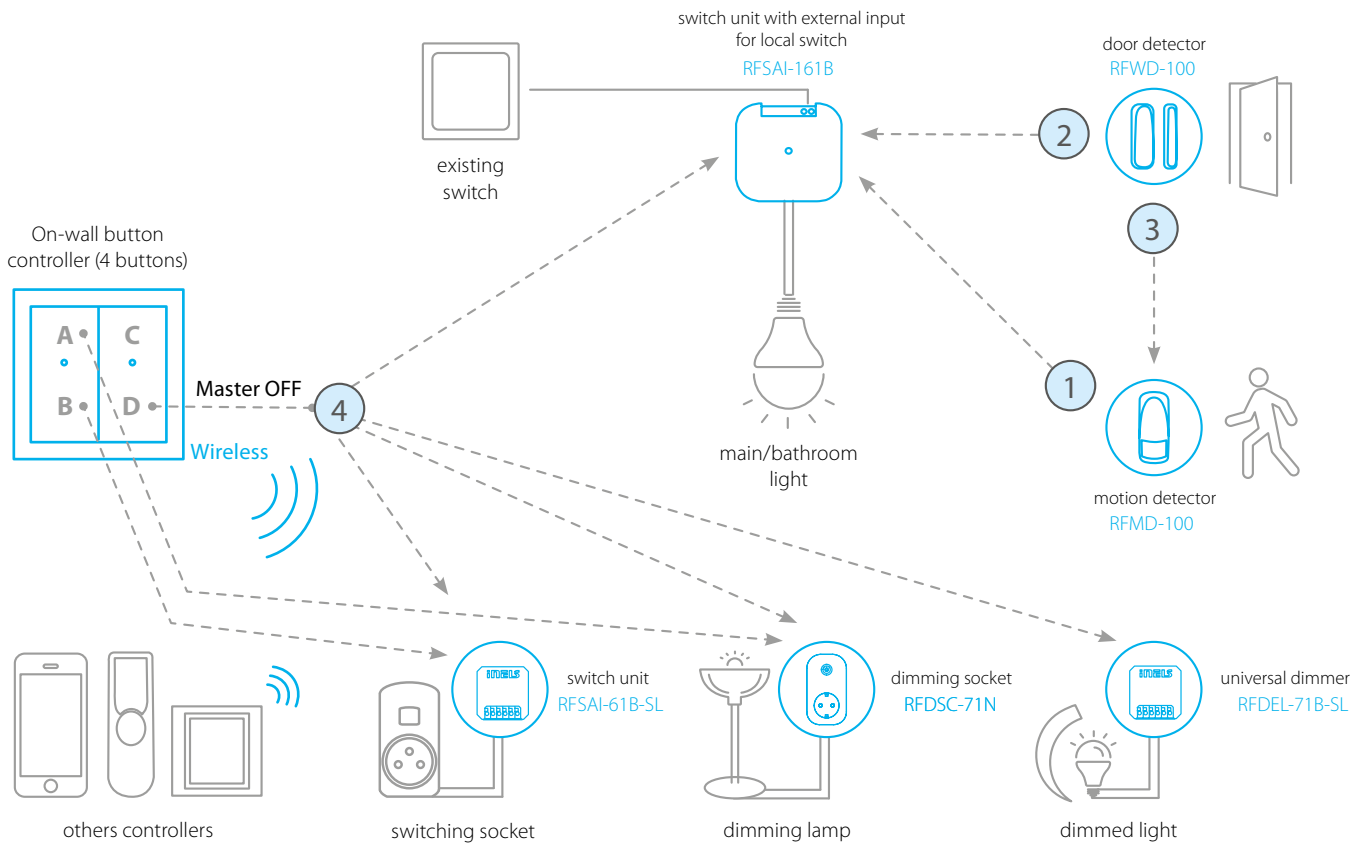

Function

- 1 When RFMD-100 motion detector captures the movement of the guest, the light ON command is sent.
- 2 The functionality of RFWD-100 door detector is delayed OFF= after the guest (or cleaner) close the door than the timer starts running (which you can set) and the light will turn OFF.
- 3 If there is movement the command from RFWD-100 door detector (delay off) will be cancelled by the motion detector RFMD-100 command.
- 4 Pressing the button at position D of RFWB-40 On-wall button controller sends an OFF command to all components that are controlled from that button while blocking the response to RFMD-100 motion detector.
- 5 You are able to control other units with other channels (A, B, C) on RFWB-40 On-wall button controller.
- 6 When guest wakes up and presses any RFWB-40 button, then pressing on button makes all units working again after previous pressing button on position D and it also re-enable RFMD-100 motion detector primary function.



EAN code:  
RFSTI-111B: 8595188149150

### Technical parameters RFSTI-111B/230V RFSTI-111B/120V

Supply voltage:	230 V AC	120 V AC
Supply voltage frequency:	50–60 Hz	60 Hz
Apparent input:	9 VA/cos φ= 0.1	9 VA/cos φ= 0.1.
Dissipated power:	0.7 W	
Supply voltage tolerance:	+10 %; -15 %	
Temperature measurement input:	1x external TZ/TC temperature sensor input $\triangleleft$	
Temp. measurement range and accuracy:	+15 to +35 °C; 0.5 °C of the range	

### Output

Number of contacts:	1x switching (AgSnO <sup>2</sup> )
Rated current:	12 A/AC1
Switching power:	3000 VA/AC1, 288 W/DC
Peak current:	30 A/max. 4 s at 10%
Switching voltage:	250 V AC1/24 V DC
Min. switching power:	100 mA/10 V
Insulation voltage between relay outputs and internal circuits:	basic insulation (Cat. III surges by EN 60664-1)
Isolates. voltage open relay contact:	1 kV
Mechanical service life:	3x10 <sup>7</sup>
Electrical service life (AC1):	5x10 <sup>4</sup>

### Control

Communication protocol:	RFIO2
Frequency:	866–922 MHz (for more information see p. 77)
Repeater function:	yes
Range:	in open space up to 160 m

### Other data

Operating temperature:	-15 to +50 °C
Storage temperature:	-30 to +70 °C
Indication of relay switch:	red LED
Indication regulation:	green LED
Operating position:	any
Mounting:	free at lead-in wires
Protection:	IP30
Overvoltage category:	III.
Contamination degree:	2
Outlets (CY wire, cross-section, length):	2 x 0.75 mm <sup>2</sup> , 2 x 2.5 mm <sup>2</sup> , 90 mm
Dimensions:	49 x 49 x 21 mm
Weight:	50 g

$\triangleleft$  Temperature sensor input is at the supply voltage potential.

- The component measures temperature in the range of 15 to 35 °C with external sensor and on the basis of the set temperature switches air conditioning.
- It is particularly suitable for hotel rooms.
- With the Window/Door sensor programmed, when the window/door is opened, the device relay contact is automatically disconnected, there by saving unnecessary energy consumed for cooling when the window/door is open.
- It enables connection of the switched load up to 12 A (3000 VA).
- Up to 4 RFWD-100 detectors can be connected to one RFSTI-111B device.
- Range up to 160 m (in open space), if the signal is insufficient between the controller and unit, use the signal repeater RFRP-20N or protocol component RFIO2 that support this feature.
- The BOX design lets you mount it right in an installation box, a ceiling or controlled appliance cover.
- External sensor TC (-20 to +80 °C) or TZ (-40 to +125 °C) for length of 3 m, 6 m, 12 m. For more information see „Accessories“ on page 44.

### Device description

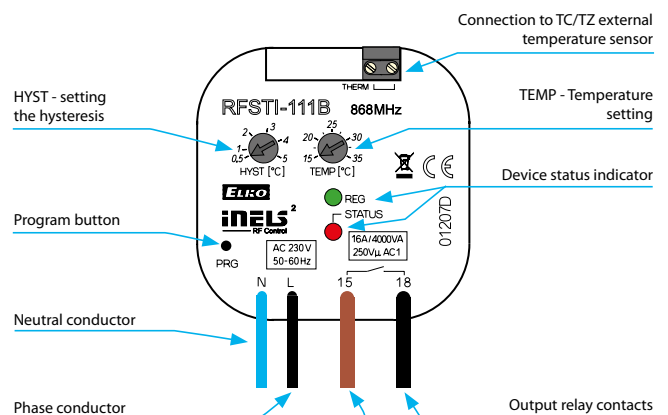

### Function

The external sensor senses the temperature of the room, turns the air conditioner on and off according to the set temperature. Responds to commands from the detector - when you open the window, turn off air conditioning.

### Connection

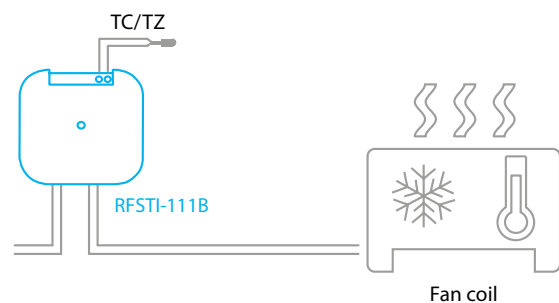

**AN-I** | Internal antenna



EAN code:  
AN-I: 8595188161862

Technical parameters	AN-I
Polarization:	vertical
Gain:	2.1 dBi
Dimensions:	17 x 44 x 8.5 mm
Impedance:	50 Ω
Colour:	black

The rod antenna with SMA connector is supplied as standard with the product.

AN-I antenna measurement graph

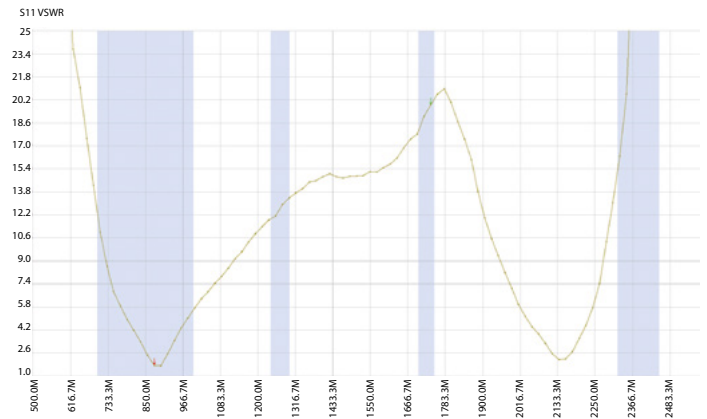

- The internal antenna is included in the standard package.

Extension cable for external antenna



10 m

Technical parameters	
Connector Type:	SMA (male/female)
Colour:	white
Cable Length:	10 m

Measured range between controllers and RFSA-66M

	RFGB	RFWB	RF KEY
<b>AN-I</b>	305 m	290 m	190 m
<b>AN-E</b>	300 m	290 m	200 m
<b>AN-E3</b>	275 m	260 m	180 m

The range is measured with direct visibility between the RFGB-x, RFWB-x, RF KEY and RFSA-66M actuators.

Connecting the antenna extension cable does not affect the range.

**RFAF/USB** | Service Key

Technical parameters	RFAF/USB
Power:	max. 1 W
Interface:	USB 1.1 and higher, plug. „A“
Range:	100 m
Min. distance of RF Touch-Actuator:	1 m
Communication protocol:	RFIO2
Frequency:	866–922 MHz (for more information see p. 77)
Power supply indication:	green LED
communication indication:	red LED
Other data	
Operating temperature:	0 to +55 °C
Storage temperature:	- 20 to +70 °C
Protection:	IP30
Contamination degree:	2
Work space:	any
Installation:	any
Dimensions:	22 x 85 x 15 mm
Weight:	20 g
Related standards:	EN 60730, EN 63044, EN 300 220, EN 301 489



EAN code:  
RFAF/USB: 8595188145039

- The RFAF/USB Service Key (in conjunction with the Wireless\_analyzer) is designed for iNELS Wireless Control system partners and serves for:
  - Setting the repeater (signal amplifier) through the iNELS Wireless Control elements labeled as RFIO2. This option allows you to communicate over longer distances (in the order of 50 m) via existing iNELS Wireless elements in the installation (eliminating the use of the RFRP-20N repeater).
  - upgrade of firmware in the iNELS Wireless elements (labeled RFIO2), in the case of new firmware versions that improve the functionality of the elements on which we are constantly working.
  - The Wireless Network Analyzer will reliably analyze the communication between the controller (where you plan to place it) and the component in the installation. Indicates signal strength/quality as well as possible frequencies that can interfere with communication.
  - SW Wireless analyzer can be found at inels.com/partners in section SW/FW Wireless Control

**AN-E1 | External antenna**



EAN code:  
AN-E1: 8595188190121

Technical parameters	AN-E1
Mounting:	Magnetic Mount
Cable Length:	3 m
Polarization:	vertical
Gain:	5 dBi
Impedance:	50 Ω
Colour:	black
Dimensions:	Ø 30 x 280 mm

AN-E antenna measurement graph

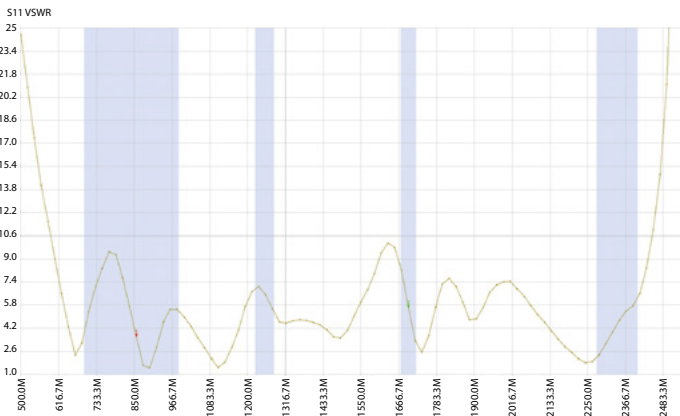

**AN-E3 | External antenna**



EAN code:  
AN-E3: 8595188190121

Technical parameters	AN-E3
Cable Length:	3 m
Polarization:	vertical
Gain:	3 dBi
Impedance:	50 Ω
Colour:	black
Dimensions:	Ø 50 x 88 mm

AN-E3 antenna measurement graph

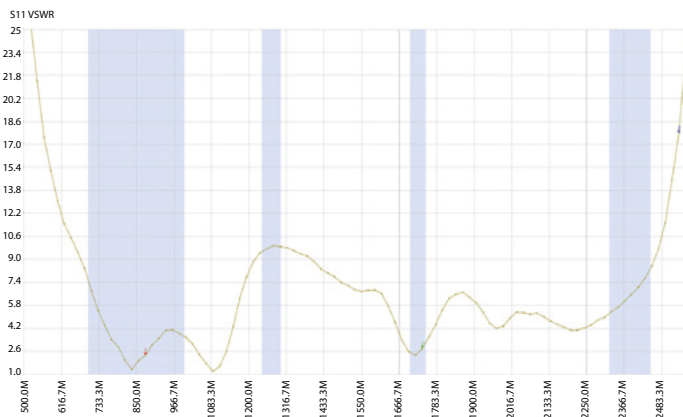

- The external antenna is intended for outdoor use.



**MS | Magnetic sensor**



- The LED sensor scans LED impulses on the meter, which indicates consumption by flashing.
- The LED sensor is particularly suitable for power meters that support LED pulse sensing (the LED on the meter is marked "imp").
- The sensor's scanner is affixed with glue above the LED diode of the meter signaling indication of consumption.
- The sensor is connected to the internal terminal of the RFTM-1 converter.

Technical parameters	MS
Voltage range:	1.6 to 3.6 V
Consumption	7uA *
Output load:	max. 3mA
Scanning period:	100ms
Switch sensing sensitivity (output L):	±(2.3 to 4.7)mT
Opening detection sensitivity (output->H):	±(0.9 to 3.8)mT
Hysteresis:	1mT
Working temperature:	-40 to 80 °C
<b>Other data</b>	
Cross-section of connecting wires:	max. 3.5 mm
Wire length:	1.5 m
Protection:	IP20

**LS | LED sensor**



- The LED sensor scans LED impulses on the meter, which indicates consumption by flashing.
- The LED sensor is particularly suitable for power meters that support LED pulse sensing (the LED on the meter is marked "imp").
- The sensor's scanner is affixed with glue above the LED diode of the meter signaling indication of consumption.
- The sensor is connected to the internal terminal of the RFTM-1 converter.

Technical parameters	LS
Voltage range:	2.5 to 3.7V
Minimum consumption (idle mode):	0.5uA *
Maximum power consumption (pulses 100Hz):	max. 2uA *
Working temperature:	-20 to 50 °C
<b>Other data</b>	
Cross-section of connecting wires:	max. 3.5 mm
Wire length:	1.5 m
Protection:	IP20

Sensor LS responds only to light pulses, i.e. it does not detect static state LEDs.

**WS | Magnetic sensor for water meter**



- A magnetic sensor that detects the pulse that is created by each rotation of the magnet placed on the unit dial meter.
- The WS sensor is especially suitable for water meters that support magnetic sensing.
- The sensing sensor is glued over the circular unit face of the gauge (the scanning dial is different from the other indicators, e.g. the white arrow wheel).
- The sensor is connected to the internal terminal of the RFTM-1 converter.

Technical parameters	WS
Voltage range:	1.65 to 5.5V
Consumption:	1.5uA *
Output load:	max. 150uA
Switch sensing sensitivity:	±(0.3 to 1.1)mT
Opening detection sensitivity:	±(0.2 to 0.9)mT
Hysteresis:	0.2mT
Working temperature:	-40 to 80 °C
<b>Other data</b>	
Cross-section of connecting wires:	max. 3.5 mm
Wire length:	1.5 m
Protection:	IP20

\* Measured at 3V, no load output.

## Smartphones



- Control application for smartphones and tablets with Android and iPhone operating systems - iHC-AiO. It allows you to easily control your house.
- The user-friendly and intuitive application environment offers central control from one place.
- The application enables control of the complete iNELS Wireless and BUS solution via the Smart RF gate, Connection server, Central unit and other supported third-party devices that are connected to the home Internet network.
- The application allows free remote control.
- IHC-AiO features:
  - unification of all iNELS devices under one application. Specifically, eLAN RF 003, eLAN RF 103, eLAN IR, CU3, CS and LARA
  - within BUS it is now possible to configure rooms without the need for a public server or CS
  - user management - in the application it will be possible to set rights for all users who will use one system
  - automation - creation of conditions within Wireless, BUS systems or in both systems
  - low battery notification, alarms, actuator status
  - history of states of individual actors
  - display of all added devices in a clear menu and the possibility of configuring your own dashboard.

Manual:

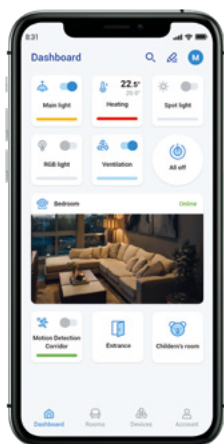

## Overview

Absolute control over the state of all technologies.

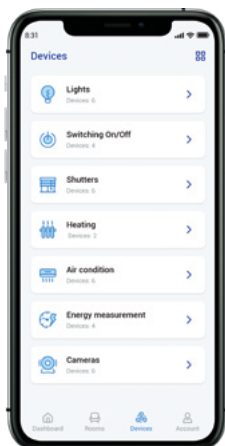

## Device list

Control the device from anywhere.

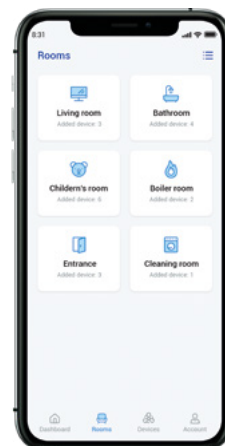

## Rooms management

Settings according to individual rooms.

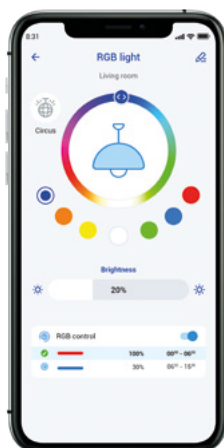

## Colour setting

Easy adjustment of the light scene with one touch - switching, dimming, colour.

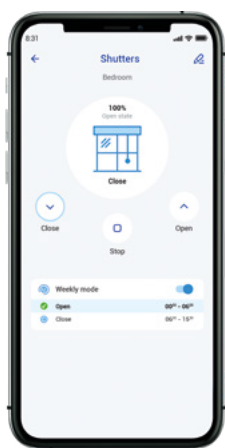

## Shutters/Blinds

Possibility of individual or joint control of shading technology.



## Temperature

You can set the temperature in each room exactly as you like.

## Smart TV



- Device control via Smart TV is possible not only in the wireless installation of iNELS Wireless Control using the smart box eLAN-RF, but also in the case of wired option iNELS BUS using the Connection server. The iHC-SMTV app is free to download from the app store on your Smart TV.
- The control of app works with a classic TV remote control.
- Every Smart TV that has been manufactured since 2015 and supports OS Tizen is compatible.
- Functionality:
  - ON/OFF switching, with the possibility of time schedules
  - dimming ON/OFF, smooth brightening/dimming, color change
  - scenes
  - heating (temperature correction, heating mode change, cooling/heating mode)
  - cameras (image, or live stream if supported by web browser on Smart TV).
- iHC-SMTV (Smart TV App) is free and is not licensed in any way.
- Here you will find a link to the application:

Download:

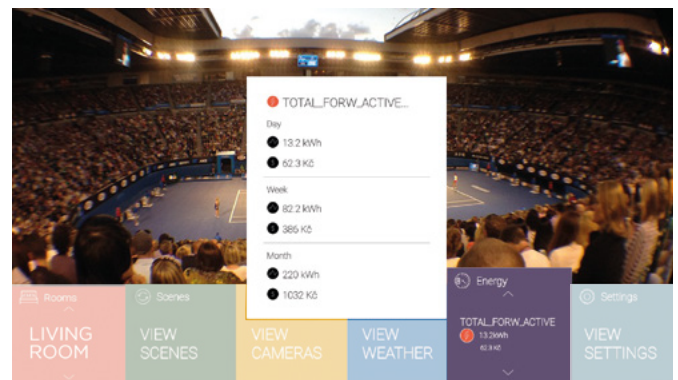
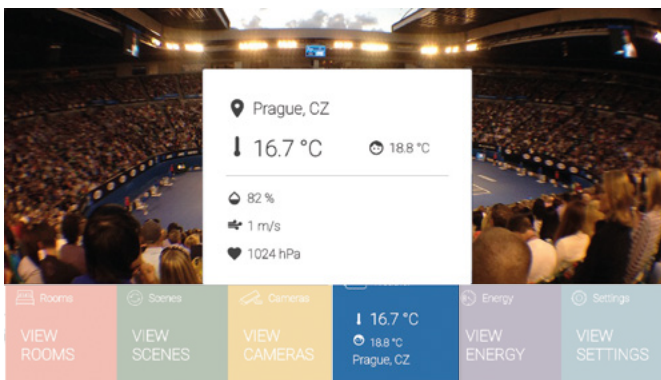
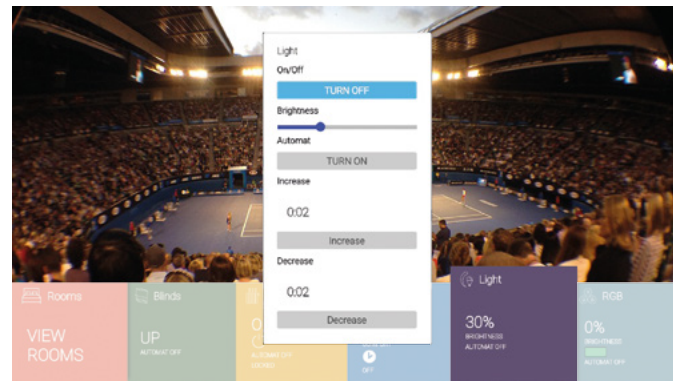
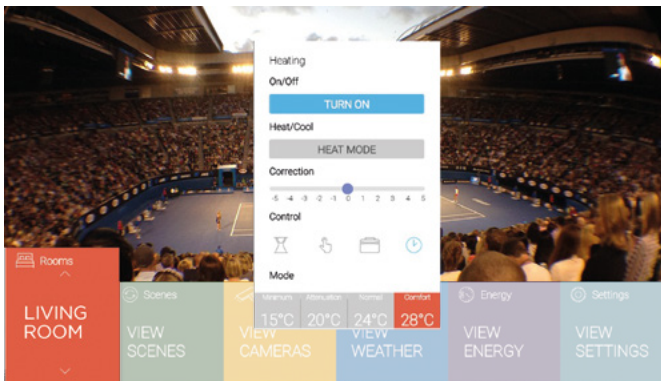
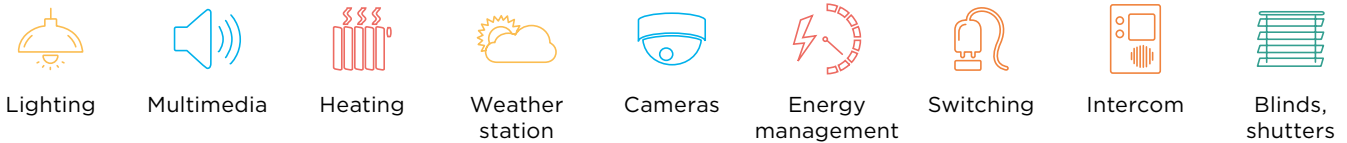

Amazon Alexa



- With Alexa Artificial Intelligence, you can simplify your daily life by setting an alarm, notifications, creating new items, or reminders in your calendar.
- The voice assistant can answer questions and control individual devices and smart homes.
- It is available on mobile phones, TVs, smart speakers and other devices.
- The voice assistant is designed to comfortably control the Wireless Control wiring by voice using your mobile phone or smart speaker.
- As a complement to Wireless Control, iNELS Smart Home Solution blends in with every modern home.
- Here you will find a link to the manual:



EN

Google Home



- Google Home can become a member of your smart home family.
- It communicates with the smart eLAN-RF box via the Cloud connection.
- This allows you to control, for example, the temperature setting or the light intensity by voice.
- The voice assistant is designed to conveniently control the Wireless Controlled electro-installations by voice using your mobile phone or smart speaker.
- As a complement to Wireless Control, iNELS Smart Home Solution blends in with every modern home.
- Here you will find a link to the manual:



EN

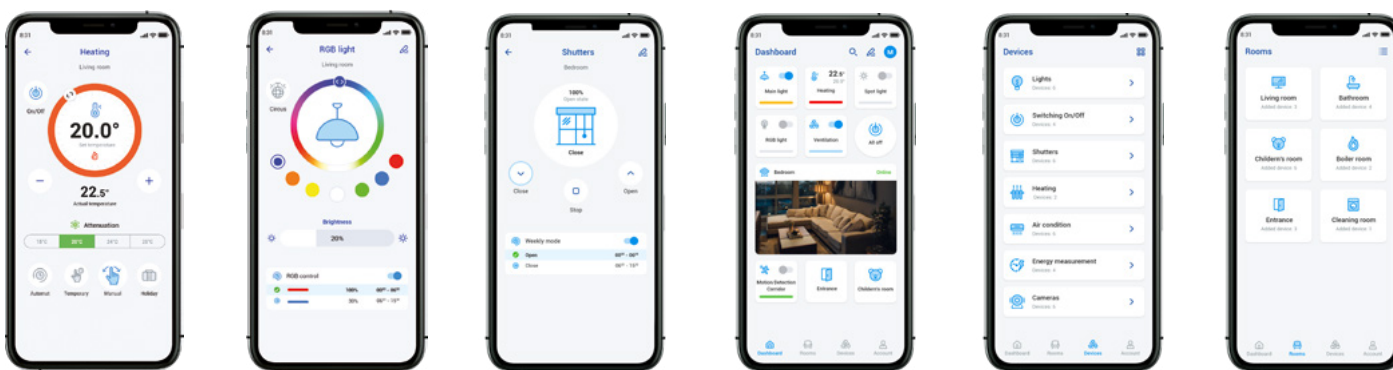

New mobile app for controlling all compatible elements from the iNELS portfolio.

Application iNELS:

- Designed for iOS 11+ and Android 7.0+.
- Optimized for devices with 1 024 x 768 screen resolution.
- The language of the application changes automatically according to the language set in Android/iOS.
- You can create a cloud account on the login screen in the app. The recommended minimum speed for connecting the eLAN-RF to the Cloud should be in the order of megabytes per second (3G - 1Mbit/s and higher).

The communication between the components is wireless at 866–922 MHz (according to country standards/regulations), using the unique RFIO and RFIO2 protocols. Both are proprietary wireless protocols from ELKO EP, which have a completely unique structure. RFIO2 is an extension of the RFIO protocol and allows users to use newly introduced features, such as unit signals (repeater), for selected features. This protocol is fully compatible with the previous version of the protocol (RFIO).

**Available frequency for individual territories:**

**865.15 MHz** India

**868.1 MHz** Russia

**868.5 MHz** EU, Ukraine, Middle East

**916 MHz** Australia, New Zealand, America, Israel

**Benefits of RFIO:**

- Communication is low-energy and reliably transfers small data packets.
- Fees or licenses are not required.
- No overlapping of communication space with unaddressed commands.
- Frequency used does not interfere with Wi-Fi/Bluetooth devices.
- Setting communication between components is not conditional on working with a computer or system.

**Benefits of RFIO2:**

- Products labeled as “RFIO2” will allow newly set selected components such as unit signals (repeaters).
- For components, you can easily update FW using the RFAF/USB service device.
- Enables communication with RFMD-100 and RFWD-100.
- Data transfer between wireless components takes place in such a way that other receivers within range can help transfer the information (packet) to a remote receiver that is out of reach. It is possible to cover large-scale objects (real estate) and also increase the reliability of transmission in more demanding buildings.
- Backward compatibility with RFIO elements is retained.

Problematic choice of suitable relay contact for a particular load switched with a product is described below. Mostly we experience problems with incorrect choice of load (meaning incorrect relay for a particular load) which results in permanent switching of contact (sealing) or damage on relay contact – which then results in malfunction. What load can you use? Detailed types of load according to standard EN 60947 are described in charts below – categories of use.

Category of use	Typical use	EN
AC current, $\cos\phi = P/S$ (-)		
AC-1	Non-inductive or slightly inductive load, resistance furnace Includes all appliances supplied by AC current with power factor ( $\cos\phi$ ) $\geq 0.95$ Examples of usage: resistance furnace, industrial loads	60947-4
AC-2	Motors with slip-ring armature, switching off	60947
AC-3	Motors with short-circuit armature, motor switching when in operation This category applies to switching off motors with short-circuit armature while in operation. While switching, contactor switches current which is 5 up to 7 times rated current of motor.	60947-4
AC-4	Electro-motors with short-circuit armature: start up, braking by backset, changeover	60947
AC-5a	Switching of electrical gas-filled lights, fluorescent lights	60947-4
AC-5b	El. bulb switching Enables low contact loading due to resistance of cold fiber is many times smaller than the one of hot fiber.	60947-4
AC-6a	Switching of transformers	60947-4
AC-6b	Switching of capacitors	60947-4
AC-7a	Switching low inductive loads of home appliances and similar applications	60947
AC-7b	Load of motors for home appliances	60947
AC-8a	Switching of hermetically sealed motors of cooling compressors with manual reset switches against overload Hermetically sealed cooling compressors have to be placed in one box without external shaft or shaft padding and motor must operate with cooling liquid	60947
AC-8b	Switching of hermetically sealed motors of cooling compressors with manual reset switches against overload Hermetically sealed cooling compressors have to be placed in one box without external shaft or shaft padding and motor must operate with cooling liquid	60947
AC-12	Switching of semiconductor loads with separation transformers	60947-5
AC-13	Switching of semiconductor loads with separation transformers	60947-5-1
AC-14	Switching of low electro-magnetic loads (max.72 VA)	60947-5-1
AC-15	Management of alternating electro-magnetic loads This category applies to switching inductive loads with input for closed electro-magnetic circuit higher than 72 VA Use: switching coils of contactors	60947-5
AC-20	Connecting and disconnecting in unloaded states	60947-3
AC-21	Switching resistive loads, including low loading	60947-3
AC-22	Switching of mixed resistive and inductive loads, including low overloading	60947-3
AC-23	Switching of motor loads or other high inductive loads	60947-3
AC-53a	Switching of motors with short-circuit armature with semiconductor contactors	60947

Note: Category AC 15 replaces formerly used category AC 11

DC current,  $t = L/R$  (s)

DC-1	Non-inductive or low inductive load, resistive furnaces	60947-4
DC-3	Shunt motors: start-up, braking by backset, reversion, resistive braking	60947-4-1
DC-5	Series motor: start-up, braking by backset, reversion, resistive braking	60947-4-1
DC-6	Non-inductive or low inductive loads, resistive furnaces – el. bulbs	60947-4-1
DC-12	Management of resistive loads and fixed loads with insulation by opto-electric element	60947-5-1
DC-13	Switching of electromagnets	60947-5-1
DC-14	Switching of electromagnetic loads in circuits with limiting resistor	60947-5-1
DC-20a(b)	Switching and breaking without load (a: frequent switching ,b: occasional switching)	60947-3
DC-21a(b)	Switching ohmic loads including limiting overloading (a: frequent switching ,b: occasional switching)	60947-3
DC-22a(b)	Switching of compound ohmic and inductive loads including limited overloads (e.g. shunt motors) (a: frequent switching, b: random switching)	60947-3
DC-23	Switching of highly inductive loads (e.g. series motors)	60947-3

How can you distinguish for which load is our product (relay) designated?

Our company record this information on a products and also in our catalogue, instruction manual and other promotional and technical material (website etc.).

It is important to realize that it is not always possible to point out load because of lack of information about the device (user cannot measure  $\cos\phi$ ) or it is not possible because of inconstancy of parameters of switched device. Manufacturer of relays records always guaranteed parameters in ideal conditions which are done by a norm (temperature, pressure, humidity, etc.) and reality can be in a lot of cases different. Category of use (classification) of a particular relay is done by material of output contacts.

Basic types of materials which are used for production of contacts for high-performance relay are:

a) AgCd – suitable for switching ohmic loads. Before of harmfulness of Cd, this type of contact is remitted.

b) AgNi – designated for switching resistive loads, good quality switching and conducting (contact doesn't oxidate) small currents/voltages, it is not designated for surge currents and loads with inductive component.

c) AgSn or AgSnO<sub>2</sub> – suitable for switching loads with inductive component, not suitable for switching small currents/voltages, it is more resistive to surge currents, suitable for DC voltage switching, less suitable for switching loads of ohmic type.

d) Wf (wolfram)-special contact designated for switching surge currents with inductive component.

e) with gold (AgNi/Au)- Used for "improving" contacts for low currents/ voltages , prevents oxidation.

RFJA-32B-SL; RFSA-62B-SL; RFSAI-62B-SL; RFSA-66M; RFSAI-11B-SL; RFSAI-62B-SL/TH; RFSW-62; RFSW-262; RFSTI-11B-SL; RFSAI-61B-SL; RFSA-61MI

Load type	$\cos \varphi \geq 0.95$								
Contact material AgSnO <sub>2</sub> , Contact 8 A	250 V/8 A	250 V/5 A	250 V/4 A	x	x	250 W	250 V/4 A	250 V/1 A	250 V/1 A
Load type									
Contact material AgSnO <sub>2</sub> , Contact 8 A	x	250 V/4 A	250 V/3 A	30 V/8 A	24 V/3 A	30 V/2 A	30 V/8 A	30 V/2 A	x

RFUS-61

Load type	$\cos \varphi \geq 0.95$								
Contact material AgSnO <sub>2</sub> , Contact 14 A	250 V/12 A	250 V/5 A	250 V/3 A	230 V/3 A (690 VA)	230 V/3 A (690 VA) up to max input C=14uF	1000 W	x	250 V/3 A	x
Load type									
Contact material AgSnO <sub>2</sub> , Contact 14 A	x	250 V/6 A	250 V/6 A	24 V/10 A	24 V/3 A	24 V/2 A	24 V/6 A	24 V/2 A	x

RFSA-61M; RFSC-61N; RFSA-61MI

Load type	$\cos \varphi \geq 0.95$								
Contact material AgSnO <sub>2</sub> , Contact 16 A	250 V/16 A	250 V/5 A	250 V/3 A	230 V/3 A (690 VA)	230 V/3 A (690 VA) up to max input C=14uF	1000 W	x	250 V/3 A	250 V/10 A
Load type									
Contact material AgSnO <sub>2</sub> , Contact 16 A	x	250 V/6 A	250 V/6 A	24 V/10 A	24 V/3 A	24 V/2 A	24 V/6 A	24 V/2 A	x

Rating of the light source ELKO lighting on dimmers ELKO EP

	LED bulb		LED spot lights			LED panels		LED / RGB strip					
	DLB-E27-806-2K7	DLB-E27-806-5K	DLSL-GU10-350-3K	LSL-GU10-350-3K	LSL-GU10-350-5K	LP-6060-3K	LP-6060-6K	LED strip 7.2W	LED strip 14.4W	LED strip 19.2W	LED strip 28.8W	RGB strip 7.2W	RGB strip 14.4W
RFDS-71N	✓ number 21	✓ number 21	✓ number 45	✓ number 25	✓ number -	-	-	-	-	-	-	-	-
RFDEL-71B-SL	✓ 11	✓ 11	✓ 25	✓ 13	✓ 13	-	-	-	-	-	-	-	-
RFDA-73M/RGB	-	-	-	-	-	-	-	✓ 3x8m	✓ 3x4m	✓ 3x5m	✓ 3x4m	✓ 20m	✓ 10m
RFDALI-32B-SL	-	-	-	-	-	✓ 50	✓ 50	-	-	-	-	-	-

**WARNING!**

May lead to different results based on the state of network cable length and other factors.

This table contains the results of tests that were conducted internally and therefore is ONLY for customers only informative. The products were tested in test laboratories ELKO EP, and therefore the company assumes no responsibility for any imitation test environment.

**Inductive and capacitive loads must not be connected simultaneously!**

Load capacity:

\* Due to the huge amount of type of light sources, the maximum load depends on internal construction of dimmable LED and ESL bulbs and their power factor  $\cos \varphi$ , capacity for power factor  $\cos \varphi=1$ . The power factor of dimmable LEDs and ESL bulbs ranges from  $\cos \varphi=0.95$  up to 0.4. An approximate value of maximum load may be obtained by multiplying the load capacity of the dimmer by the power factor of the connected light source.

There are different types of pairing according to the factory version of the driver. Due to technological advances, which are inevitable even in our products, you can have controllers with or without a pairing button. You can identify the controller with the pairing button by the mark  on the print on the back of the instrument panel and the physical presence of the pairing button on the controller.

To position the pairing buttons on your controllers:

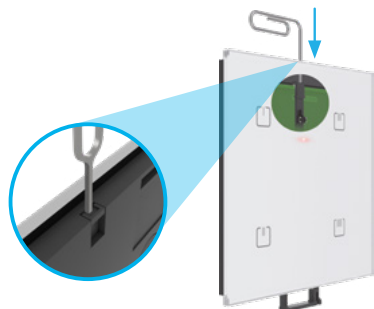

#### RFGB (both round and sharp versions):

Pressing on the upper control mandrel (paper clip, screwdriver) will eject the battery and the pairing button is released.

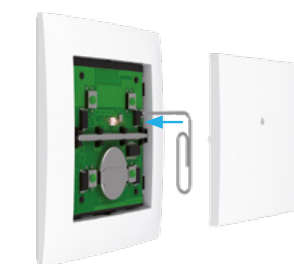

#### RFWB:

By removing the controller flap, the pairing button is accessed.

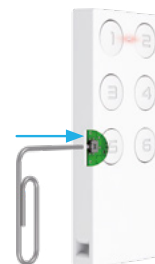

#### RF Key

It is located on the side near the button number 5.



## To assign a controller using the pairing button

Hold the pairing button for 1 second to put the controller into pairing mode – the red LED indicates with a short flash. Next, hold the PROG button on the device you want to control for 1s, 2 sec or 3 s (see **Tab 1** **PROG button modes**) Next, continue setting the functions (1 to 6) by pressing the appropriate button on the controller with the appropriate number of presses (see **Tab 2**). Finish programming by briefly pressing the PROG button on the device and briefly pressing the pairing button on the controller. We recommend that you first enter the controller into pairing mode and then the device. Putting the controller and the device into pairing mode is signaled by a red LED with a short blink.

Press (1s), Short press (>1s), Long press (1s >)

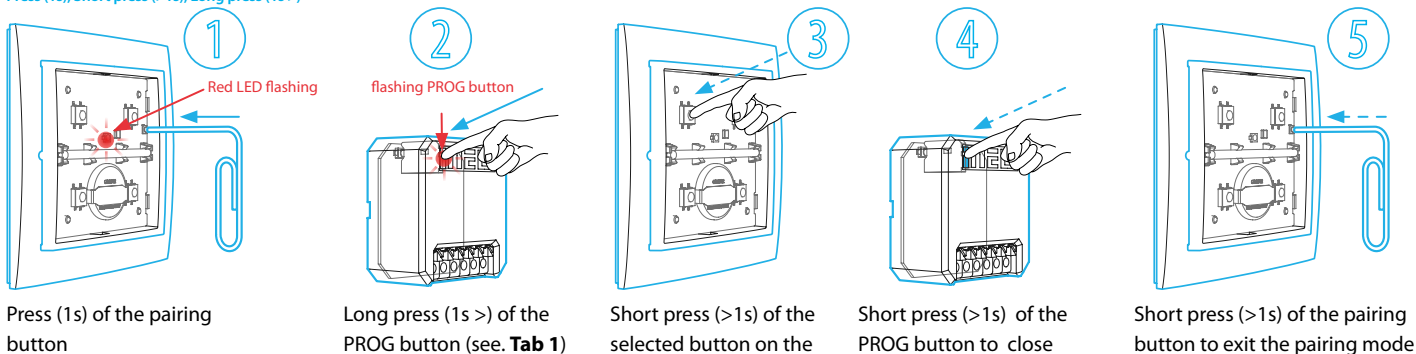

Controller = transmitter (i.e. RFGB, RFWB, RFKEY, etc.)

Device = receiver (e.g. RFSAx, RFIM, RFSG or RFDELxx etc.)

## Assign a controller without a pairing button

Procedures without a pairing button are used to assign older controls to devices, and two pairing options are possible, depending on the version of the device. This is a pairing without putting into the so-called „pairing“ „Compatibility Mode“ or with the introduction to „Compatibility Mode“ mode (the oldest possible version).

\*\*\*\*

#### Fast flashing:

The controller is in the state: Pairing in Compatibility Mode (VRK)

•\*•\*•

#### Short double flashes:

The driver is in the state: Pairing without compatibility mode (BRK)

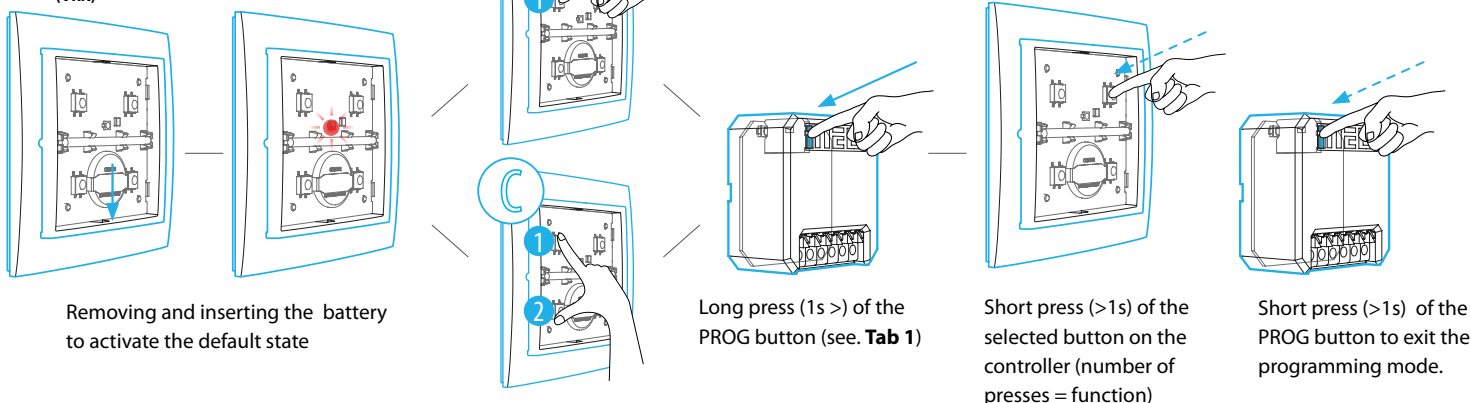

Removing and inserting the battery to activate the default state

Long press (1s >) of the PROG button (see. **Tab 1**)

Short press (>1s) of the selected button on the controller (number of presses = function)

Short press (>1s) of the PROG button to exit the programming mode.



## B Pairing without compatibility mode

First, insert the battery into the controller. If the battery has already been inserted into the controller, remove it for at least 5 s to restore it to its default state. After inserting the battery, while the red LED is lit (3 s), press and hold 1 until the controller starts to indicate the driver mode by briefly flashing the LED. Then release the button to make the controller ready for pairing. Next, hold down the PROG button on the device you want to control for 1, 2 or 3 s (see **Tab 1**) continue to set functions 1 to 6 by pressing the appropriate button on the controller with the appropriate number of presses (see **Tab 2**). Finish programming by briefly pressing the PROG button on the device and removing and reinserting the battery into the controller.

## C Pairing in compatibility mode

To pair the oldest versions of devices with drivers, it is necessary to switch the driver to Compatibility Mode. Remove the battery from the controller 5 s. After inserting the battery, the red LED is on for 3 s, press and hold 1 and 2 at the same time and keep them pressed until the controller signals the transition to Pairing in compatibility mode by flashing rapidly. Then the buttons must be released. The controller, which is in Compatibility Mode, is ready for pairing, so you only need to put the device into pairing mode. 1 s, 2 s or 3 s (depending on type see. table Modes of the PROG button) and continue setting functions 1 to 6 by pressing the appropriate button on the controller with the appropriate number of presses according to the manual of the device. Finish programming by briefly pressing the PROG button.

Switching between 1 and 2 modes also works the other way around, so you can switch back to Pairing without compatibility mode (transition indicator – double flash).

**Table 1) Modes of the PROG button on the devices**

Applies to:	Applies to: Entering pairing mode (Step 2)	Clearing channel/ button memory	Clear the memory of an entire device
RFSA-11B, RFSAI-11B-SL, RFSA-61B, RFSA-61B-SL, RFSA-61M, RFSA-61MI, RFSA-66M, RFSA-66MI, RFSC-61, RFUS-61, RFDA-11B, RFDEL-71B, RFDEL-71M, RFDEL-76M, RFDALI-04B, RFDALI-32B, RFDA-73M/RGB, RFDSC-71N	1 s	5 s	8 s
RFSAI-62B-SL, RFSA-62B, RFSAI-62BRFSW-62, RFSW-262, RFDW-71, RFDW-271	3 s	7 s	11 s
RFDAC-71B	2 s	5 s	10 s

### Clear the memory of the button

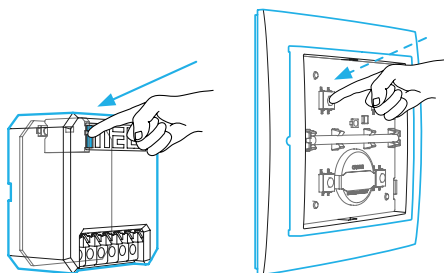

To clear an already paired channel to a button on the controller, press the PROG on the device for a period of time of 5 s or 7 s (see **Tab 1**). Clear the memory of the button and press the appropriate button on the controller that you want to unpair. After this step, it returns to its working state.

### Clear the memory of the whole device

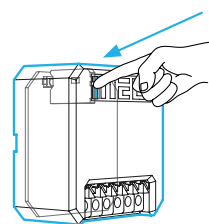

If you want to clear the memory of the whole device (unpair all buttons or delete all channels at once, press the PROG button on the device for 8/10/11 s according to the type of device (see. Tab 1). Clearing the memory of the entire device. The device remains in pairing mode.

## DRIVER DEVELOPMENT AXIS











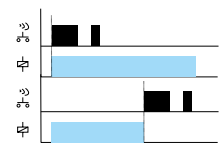
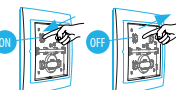







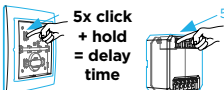
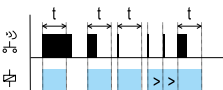
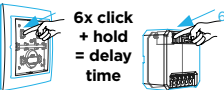
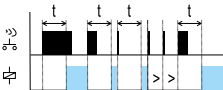

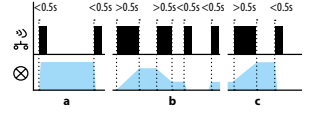

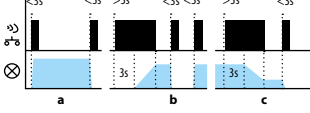

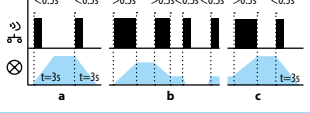

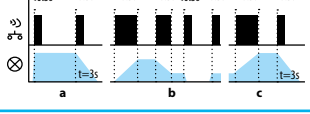
### Please note:

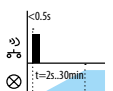
If you are pairing older versions of drivers or features with each other, it is not possible to clearly determine whether you need to use Compatibility Mode for pairing or not. Therefore, you need to try both ways.

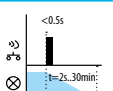
RF Key/W and RF Key/B key fobs and other drivers of the oldest possible version can no longer be paired with devices that have radio wavelet markings on the PROG button. RFSAI-62-SL, RFSA-62B, RFSAI-62B and RFDAC-71B units have a different pairing method. Always follow the instructions for the devices.

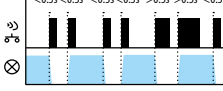
Table 2) Programming of feature functions

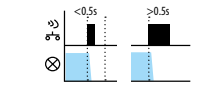
Single function - RFSA-11B-SL		
Assign a function	Feature description	Graph
 <p><b>1x click</b></p>	<p><b>Function button ON/OFF</b> The output contact closes by pressing one button position, and opens by releasing the button.</p>	
It is a single-function relay, so when programming the ON function on the upper pusher, the OFF function is assigned to the button below it automatically		
Spínací prvky multifunkční - RFSA-61B, RFSA-62B-SL, RFSA-61M, RFSA-66M, RFSAI-62B-SL, RFSC-61N, RFUS-61		
 <p><b>1x click</b></p>	<p><b>Function 1 - button</b> The output contact will be closed by pressing the button and opened by releasing the button.</p>	
 <p><b>2x click</b></p>	<p><b>Function 2 - switch on</b> The output contact will be closed by pressing the button.</p>	
 <p><b>3x click</b></p>	<p><b>Function 3 - switch off</b> The output contact will be opened by pressing the button.</p>	
 <p><b>4x click</b></p>	<p><b>Function 4 - impulse relay</b> The output contact will be switched to the opposite position by each press of the button. If the contact was closed, it will be opened and vice versa.</p>	
 <p><b>5x click + hold = delay time</b> 5 s hold</p>	<p><b>Function 5 - delayed off</b> The output contact will be closed by pressing the button and opened after the set time interval has elapsed. <math>t = 2\text{ s} - 60\text{ min}</math>.</p>	
 <p><b>6x click + hold = delay time</b> 6 s hold</p>	<p><b>Function 6 - delayed on</b> The output contact will be opened by pressing the button and closed after the set time interval has elapsed. <math>t = 2\text{ s} - 60\text{ min}</math>.</p>	
The timing function (5 and 6) is performed by combining multiple presses and tracking the time for which we want to activate the delayed return or start (see. Manual for switching devices).		
Stmívací prvky multifunkční RFDA-73M/RGB, RFDEL-71B-SL, RFDEL-71M, RFDCS-71N, RFDAC-71B, RFDW-71		
 <p><b>1x click</b></p>	<p><b>Light scene function 1</b> The brightness level is saved in the memory, and pressing the button shortly later will switch the light on/off to this intensity. It is possible to readjust the change in intensity at any time by a long press of the programmed button. The actuator remembers the adjusted value even after disconnecting from the power supply.</p>	
 <p><b>2x click</b></p>	<p><b>Light scene function 2</b> The brightness level is saved in the memory, and pressing the button shortly later will switch the light on/off to this intensity. It is possible to readjust the change in intensity at any time by pressing the programmed button for over 3 s. The actuator remembers the adjusted value even after disconnecting from the power supply.</p>	
 <p><b>3x click</b></p>	<p><b>Light scene function 3</b> The brightness level is saved in the memory, and pressing the button shortly later will switch the light on/off to this intensity. It is possible to readjust the change in intensity at any time by a long press of the programmed button. The actuator remembers the adjusted value even after disconnecting from the power supply.</p>	
 <p><b>4x click</b></p>	<p><b>Light scene function 4</b> The brightness level is saved in the memory, and pressing the button shortly later will switch the light on/off to this intensity. It is possible to readjust the change in intensity at any time by a long press of the programmed button. The actuator remembers the adjusted value even after disconnecting from the power supply.</p>	
 <p><b>5x Click + hold = time</b> 5s hold</p>	<p><b>Function sunrise</b> After pressing the programmed button, the light begins to illuminate in the programmed time interval in a range of 2 seconds to 30 minutes.</p>	
 <p><b>6x Click + hold = time</b> 6s hold</p>	<p><b>Function sunset</b> After pressing the programmed button, the light begins to dim in the programmed time interval in a range of 2 seconds to 30 minutes.</p>	
 <p><b>7x click</b></p>	<p><b>Function ON / OFF</b> If the light is switched off, pressing the programmed button will switch it on. If the light is switched on, pressing the programmed button will switch it off.</p>	
 <p><b>8x click</b></p>	<p><b>Function switch OFF</b> The dimmer output switches off by pressing the button.</p>	

The sunrise and sunset function is performed by combining multiple presses and tracking the time for which we want to activate the delayed return or start (see. Manual for switching devices).



**1) Surface mounted**

Wall mounted or in an installation box with spacing of 65 mm.

- |             |             |          |
|-------------|-------------|----------|
| RFWB-20/G   | RFGB-40B/MT | RFGB-220 |
| RFWB-40/G   | RFGB-40W/MT | RFGB-240 |
| RFWB-40G/MT | RFTC-10/G   |          |
| RFGB-20     | RFTC-50/G   |          |
| RFGB-40     | RFTC-150/G  |          |

**2) Flush mounted**

- |            |           |
|------------|-----------|
| RF Touch-2 | RFSW-62/S |
| RFDW-71    |           |
| RFDW-271   |           |
| RFGS-30/S  |           |

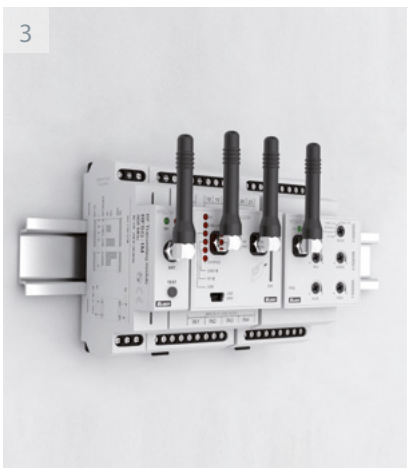

**3) DIN Rail mounted**

On DIN rail according to EN 60715.

- |              |           |
|--------------|-----------|
| RFSG-1M      | RFSA-61M  |
| RFDA-73M/RGB | RFSA-66M  |
| RFDEL-71M    | RFSA-66MI |
| RFSA-266M    | RFSA-61MI |
|              | RFDEL-76M |

**4) Flush mounted (BOX)**

- |                 |                 |
|-----------------|-----------------|
| RFIM-40B-BP-SL  | RFSAI-62B-SL    |
| RFIM-40B-230-SL | RFSAI-61BPF-SL  |
| RFDALI-32B-SL   | RFJA-32B-SL     |
| RFDALI-04B-SL   | RFSTI-11B-SL    |
| RFDEL-71B-SL    | RFSAI-161B      |
| RFSAI-11B-SL    | RFSTI-111B      |
| RFSA-61B        | RFSAI-62B-SL/MT |



**5) Mounted into the cover of appliance**

- |               |              |                 |
|---------------|--------------|-----------------|
| RFDALI-32B-SL | RFSAI-62B-SL | RFSTI-111B      |
| RFDALI-04B-SL | RFSAI-BPF-SL | RFSAI-62B-SL/MT |
| RFDEL-71B-SL  | RFJA-32B-SL  |                 |
| RFSAI-11B-SL  | RFSTI-11B-SL |                 |
| RFSA-61B      | RFSAI-161B   |                 |

**6) Surface mounted**

- |          |          |
|----------|----------|
| RFSOU-1  | RFWD-100 |
| RFUS-61  | RFOWB-20 |
| RFTM-100 | RFMD-200 |
| RFSF-100 | RFSLT-S3 |
| RFMD-100 |          |

Product dimension

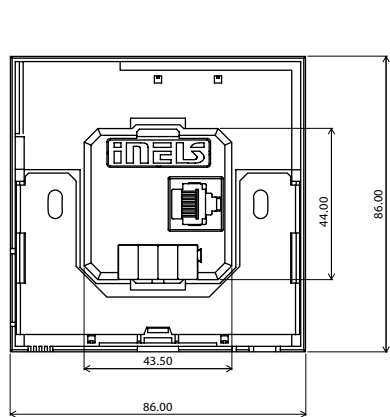

RF Touch 2

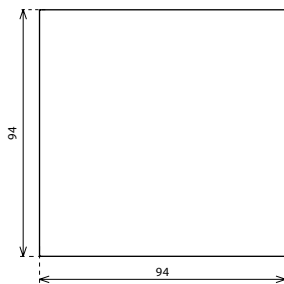
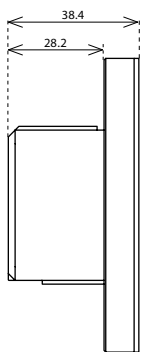

Flush-mounted

Surface-mounted

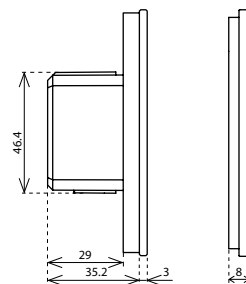

RFSW-62  
RFDW-71

RFGB-20/G  
RFGB-40/G  
RFBW-40G/MT

RFGB-40B/MT  
RFGB-40W/MT

Surface-mounted

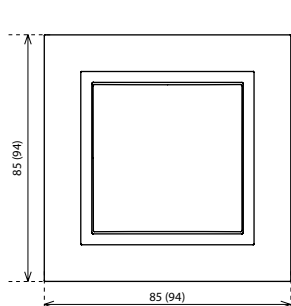

Frame dimensions are given (for metal frames, glass, wood, granite)



RFWB-20/G  
RFWB-40/G  
RFWB-40/MT

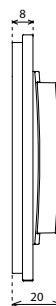

RFTC-10/G  
RFTC-50/G  
RFTC-150/G

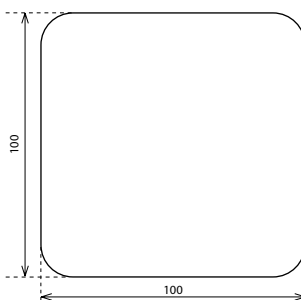

Flush-mounted

Surface-mounted

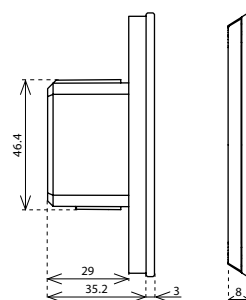

RFSW-262  
RFDW-271  
RFGS-30/S  
RFSW-62/S

RFGB-220/G  
RFGB-240/G

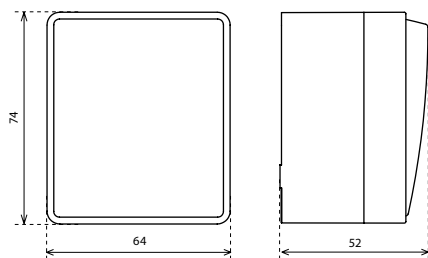

RFOWB-20

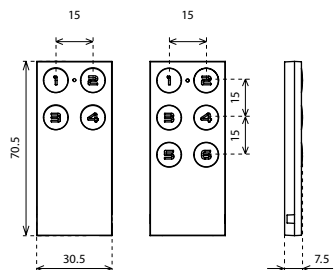
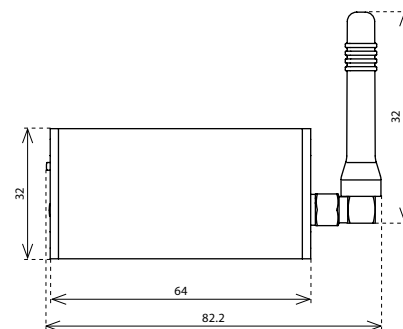
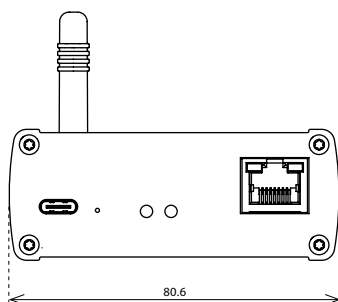

RF KEY-40

RF KEY-60

BOX

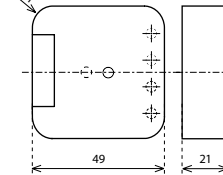

RFSA-61B  
RFSA-161B  
RFSTI-111B  
RFDEL-71M

BOX

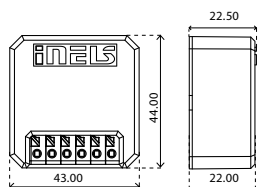

- RFIM-40B-230-SL
- RFDALI-32B-SL
- RFDALI-04B-SL
- RFSTI-11B-SL
- RFSAI-11B-SL
- RFDEL-71B-SL
- RFDEL-71B-SL/MT
- RFJA-32B-SL
- RFSAI-62B-SL
- RFSAI-61BPF-SL
- RFSAI-61B-SL
- RFSAI-62B-SL/MT
- RFIM-40B-BP-SL

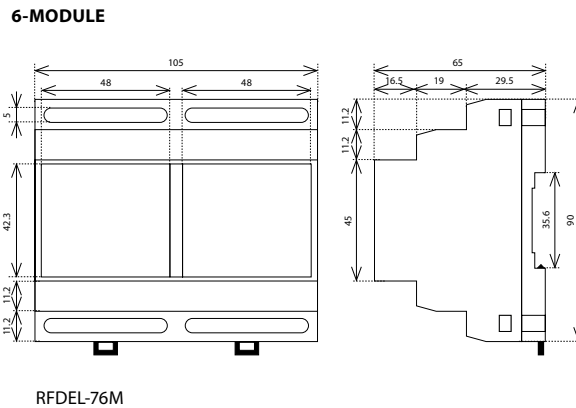
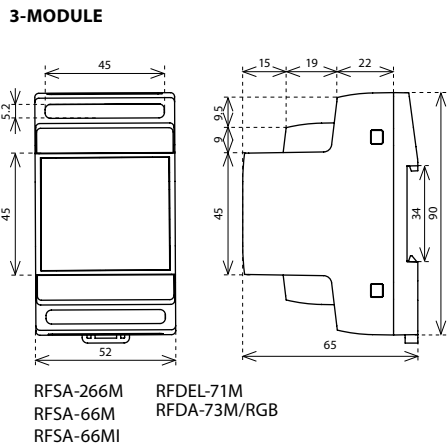
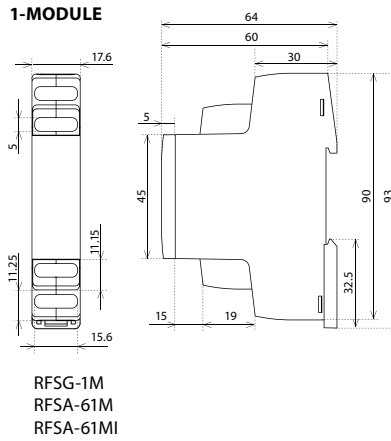
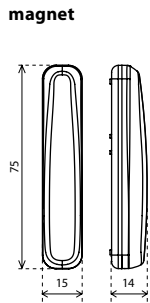
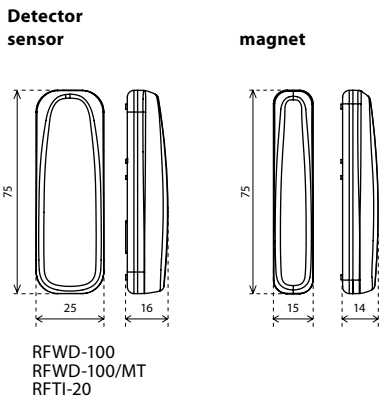
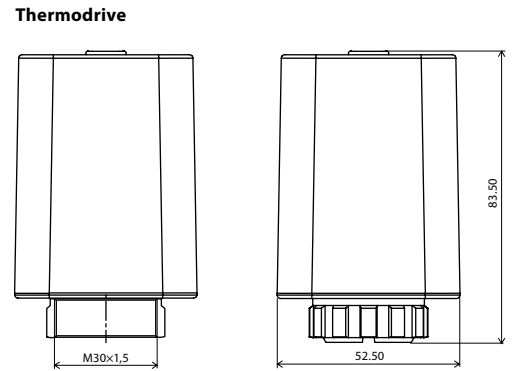
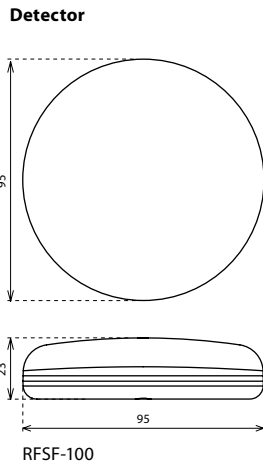
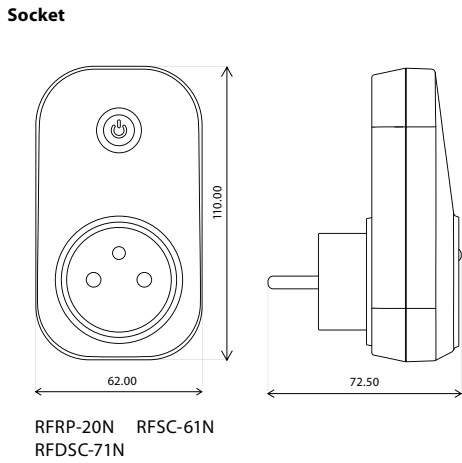
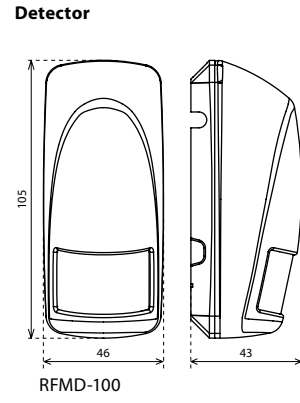
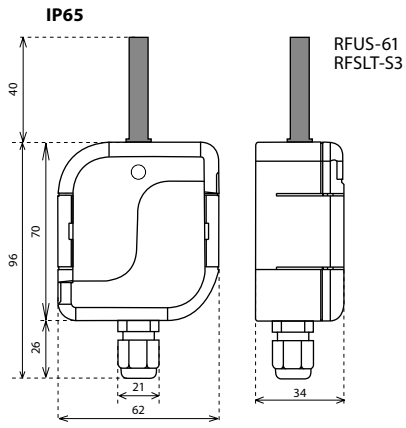
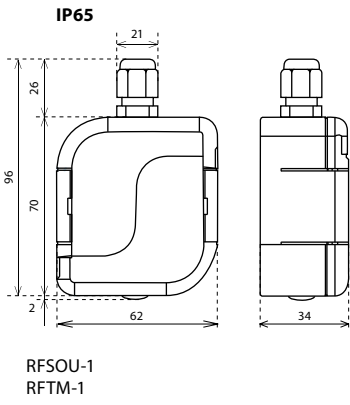

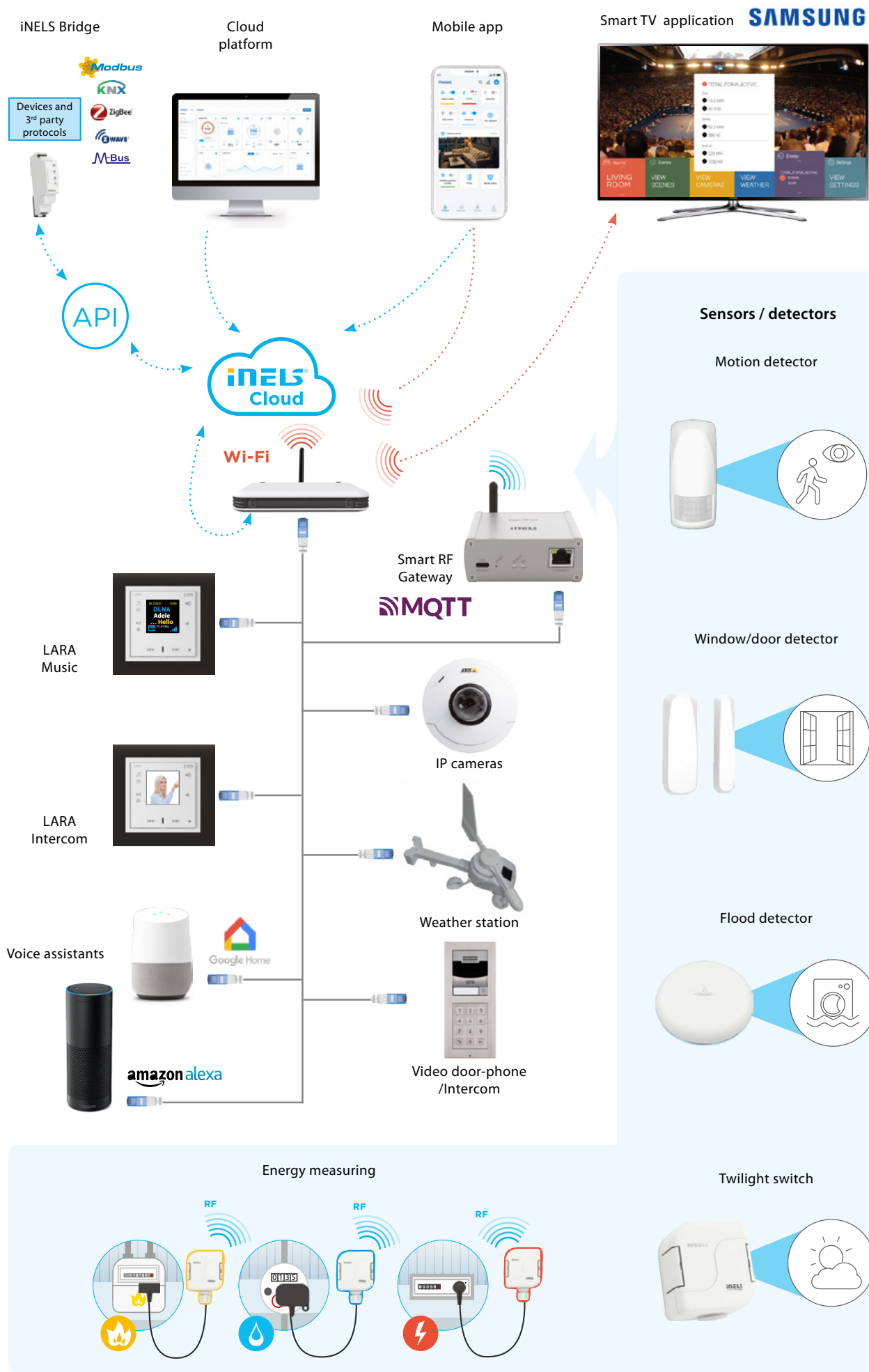

Actuators

Controllers

Switching socket

Universal dimmer R-L-C-LED-ESL

Switch unit for shutters

Thermovalve

Switch unit 6-channels

DALI controller

Switch unit for outdoor use

On wall button controller

Glass touch controller

Glass touch with dimmer

Key fob

Input contacts converter

Outdoor controller IP 65

Control unit

Temperature controller



● **Headquarters**

ELKO EP Holding SE, Czech Republic

---

● **Europe**

ELKO EP Balkan d.o.o  
ELKO EP Bulgaria OOD  
ELKO EP Germany GmbH  
ELKO EP Hungary Kft.  
ELKO EP POLAND Sp. z o.o.  
ELKO EP SLOVAKIA, s.r.o.  
ELKO EP UK Ltd.  
ELKO EP UKRAINE LLC

● **Africa & Middle East**

ELKO EP Egypt LLC  
ELKO EP Kuwait Ltd.  
ELKO EP MEA LLC  
ELKO EP Saudi Arabia Ltd.  
ELKO EP South Africa PTY Ltd.

● **America**

ELKO EP North America LLC

---



**ELKO EP, s.r.o.** | Palackeho 493 | 769 01 Holesov, Vsetuly | Czech Republic  
phone: +420 573 514 221 | fax: +420 573 514 227 | [elko@elkoep.com](mailto:elko@elkoep.com) | [www.elkoep.com](http://www.elkoep.com)

Published: 10/2023 | Modifications or amendments reserved | © Copyright ELKO EP, s.r.o. | 1<sup>st</sup> edition