

# Highlights 2023



News from iNELS & ELKO EP World.

[www.elkoep.com](http://www.elkoep.com)

## What's new?

- iNELS comes with new Topology in Central units
- MQTT in Central units
- Smart Kits
- iNELS Cloud
- New products



Mobile App iNELS is Available on:



# CONTENT

## HIGHLIGHTS 2023

- Products Portfolio 4-5
- New mobile app iNELS 6-9
- iNELS BUS – IP infrastructure 10-13
- iNELS RF Touch-2 14
- Easier installation iNELS RF 15
- iNELS Smart Kits 16-18
- Smart Expandable System 19
- iNELS & 3rd part solution 20
- iNELS Cloud 21
- New Products 22-27  
Relays, iNELS BUS, iNELS
- References 28-29
- About ELKO EP 30-31

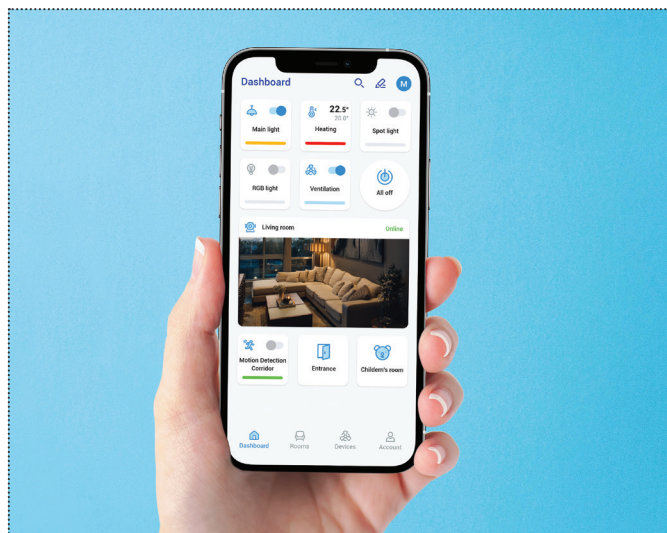

### Clear, intuitive, modern

#### iNELS 2023 starts a new mobile app.

New generation of iNELS application for monitoring and control of all iNELS devices, regardless of whether it is BUS or wireless technology with many useful functions, the list of which is constantly growing. Now available for free on Google Play and the App Store.

... see page **6-9**



### iNELS Smart Kits

#### Starter kits for every household.

Starter kits for every household, it is an easy and fast solution for typical cases of home use, such as moving a wall switch, equipping common lights with dimming functions, remote control of blinds and shutters, advanced heating control.

... see page **16-18**

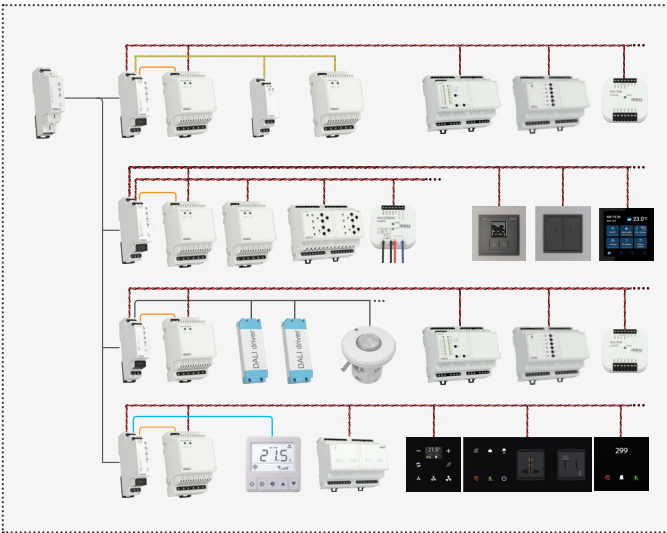

## iNELS BUS new approach

### Evolution in the iNELS BUS system.

This is a new approach in the use of the IP protocol to interconnect individual central units and buses connected to them. The new IP infrastructure brings with it completely new possibilities of using buses in small, medium and very large installations.

... see page **10-13**



## Wireless RF Touch 2

### Wall touch panel with smart box functions.

New central element for controlling heating, switching electrical appliances and equipment, dimming lights or controlling blinds and detectors. It's RF-Touch-2.

... see page **14**

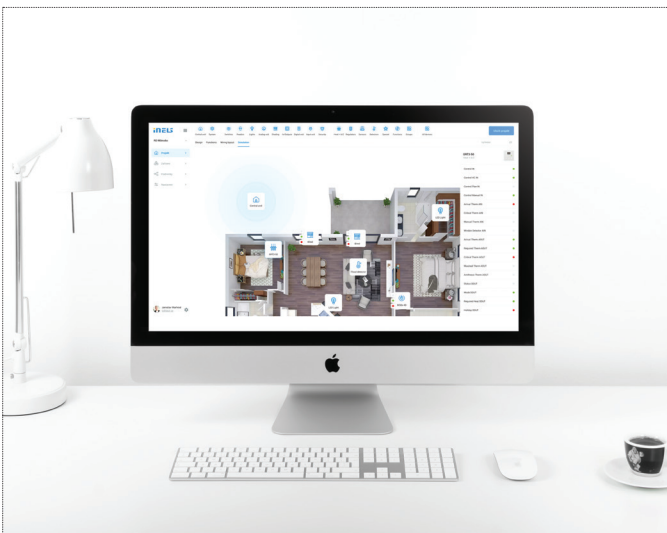

## iNELS Cloud with new frontend

### Creativity and availability.

In the iNELS Cloud, you will get all the device connected to the cloud enabled central units/gateways. Rule engine offers numerous benefits to customers by enabling iNELS devices to automate and simplify their safety and comfort. The new feature allows to control all units via web page and see the history and graphs from the dashboard.

... see page **21**



## iNELS Bridge

### Bridge to 3rd Party integration.

With iNELS Bridge, It has become easier than ever for both Installers and integrators to connect the iNELS system to the 3rd party world. iNELS Bridge act as a gateway between iNELS portfolio to 3rd party system. The unit comes with an option of pre-installed Home Assistant, Connection server and Asterisk.

... see page **25**

# Wide range of electronics

## Timers / Relays



A wide range of electronic modular devices, which bring new possibilities to home and office control, monitoring and security, as well as to industrial process control: time relays, installation contactors, staircase automatic switches, time switches clocks, thermostats, power supplies units, etc.

## Protection monitoring relays



Every household, every object and every machine needs a monitoring relay. There are several reasons why, overvoltage, undervoltage, phase failure, asymmetry, frequency, or power factors.

## Switches and sockets



This portfolio covers a variety of colorful and elegant accessories suitable for interior use or even more demanding areas such as workshops or industrial objects.

## Hotel Wireless Retrofit



Hotel Room Energy Saving Kit (HRESK) - Solutions for hotel rooms based on wireless technology is designed to function in existing hotels. It is possible to simply elevate the existing electrical installation to a higher level without long-lasting construction modifications.

## Guest Room Management System



Guest Room Management System - The BUS system is designed mainly for hotels and offers comfortable and easy control of hotel rooms, reception and restaurant.

## Building management system



Building Management System (BMS) is a comprehensive solution for monitoring, and controlling even the most complex of building systems. You can monitor everything on your computer monitor or tablet in the comfort of reception or office.



## Wireless electroinstallation (RF)



The system uses wireless communication between devices. The installation itself is variable thanks to this communication and can be gradually expanded.

## Wired electroinstallation (BUS)



The BUS system offers a unique solution for new installations (refurbishment) in family houses, hotels and villas. It offers a wide range of functions for both automation and comfort.

## Lighting control



A sector that offers complete control over all lighting devices. From switching, dimming to controlling your favourite DALI luminaires. Everything can be controlled with a connection to iNELS wired or wireless technology.

---

## Multimedia



Here you can find extensions for our iNELS system and not just for it. Lara Music Players, Intercoms and Door Communicators, Application Communication Servers and 3rd party applications.

## SW Solution

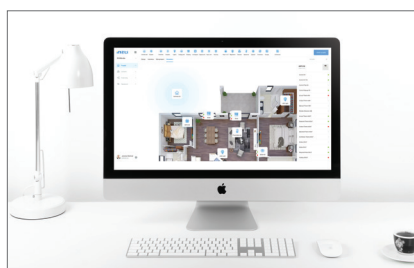

This portfolio covers a variety of colorful and elegant accessories suitable for interior use or even more demanding areas such as workshops or industrial objects.

## Apps

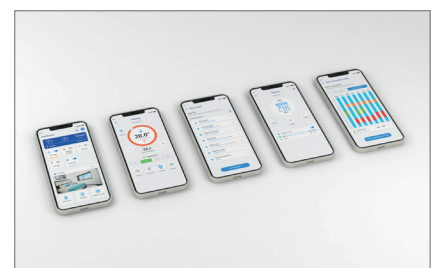

The building is under control anytime and anywhere. Thanks to the iNELS app, it is available via any mobile device - mobile phone or tablet. Remote monitoring, notification, control functions - all this allows immediate overview and management.

## New mobile App iNELS

# Clear, intuitive, modern.

Another addition to the family of mobile applications for controlling iNELS devices is the new mobile application with the distinctive name “iNELS”, in which great emphasis is placed on the graphic design and intuitive operation.

The new application will be the only one to enable the control of wireless elements from the iNELS RF portfolio using the new eLAN-RF-103 system control unit. It is now possible to control all the device connected to the BUS central units from the new app.

The application allows you to easily control connected devices such as socket switching, dimming of lights, control of blinds or garage doors, control of heating circuits and compatible air conditioning. Of course, the display of available values, such as temperature, status of motion, window, door or flood detectors, or the current status of all controlled devices.

It now brings a clear Dashboard, on which it is possible to display the most used devices, previews of connected cameras or created scenes. With one click, you can control several devices at once.

The iNELS application will be gradually supplemented with the possibility of connecting new devices, new system and new central units as well as third-party devices. Enter a whole new stage with the new iNELS mobile application in expanding the functions and integration options of the iNELS 2023 system.



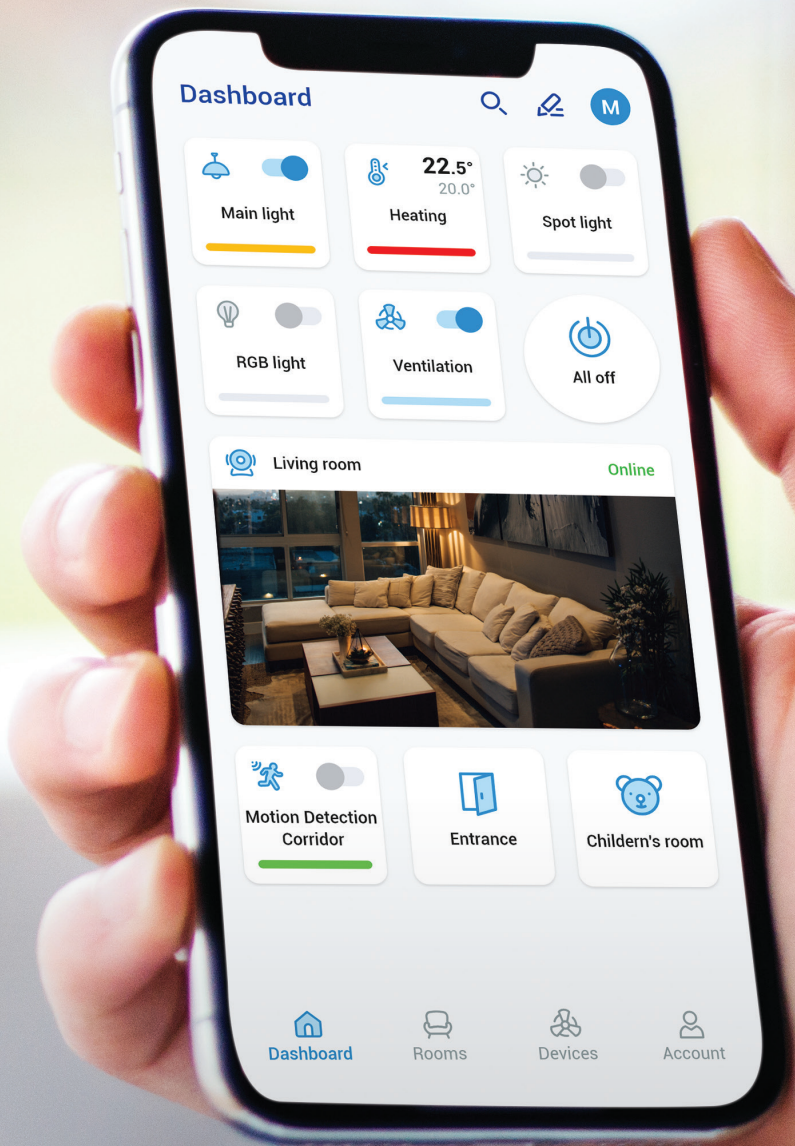

# Try the application iNELS

Available on iPhone & All Android Devices

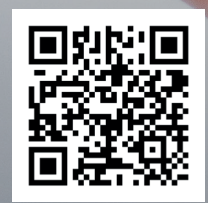

# Function preview

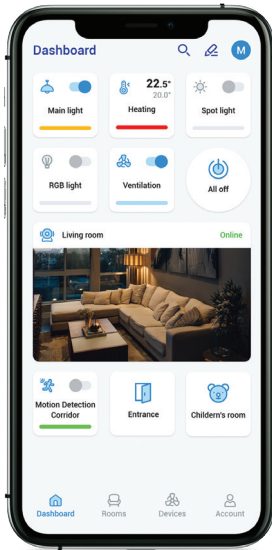

## Dashboard

Clear dashboard with a number of widgets for easy control of the most used devices. This is a house on one screen and on one click.



## Temperature control

Room temperature comfort and energy saving at every moment. Monitor the heating or cooling of the house and control it remotely as needed.

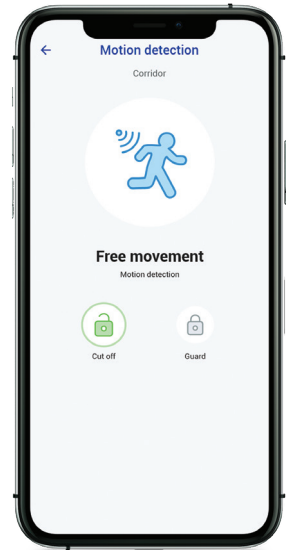

## Security

Don't be surprised, be safe. Be informed immediately about a possible threat and keep track of what's going on in the house from anywhere.

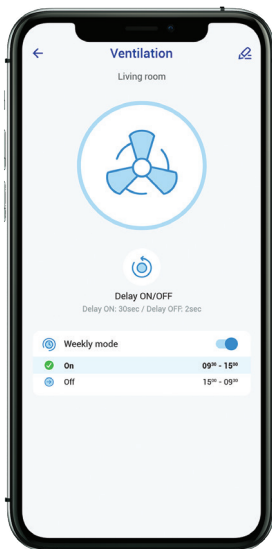

## Switching

Don't have smart appliances? Don't despair, thanks to the switching elements you can fully integrate and control just like any iNELS unit.

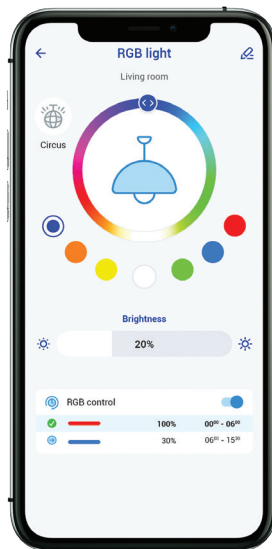

## Lights

Take advantage of all the possibilities of light comfort and energy saving. Adjust the light intensity, use the dimming function, play with the color of the lights, all with a simple and intuitive tool.

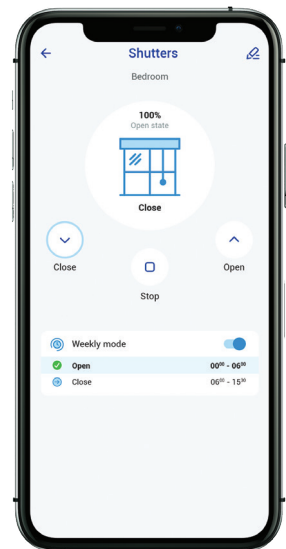

## Shutters

You don't want to get out of bed, but would you like to pull the blinds up? And let them pull down automatically in the evening when it's dark? Do it.





### Time schedules

Let your house work for you. Take full advantage of building automation functions, whether in the form of time schedules or smart scenarios.

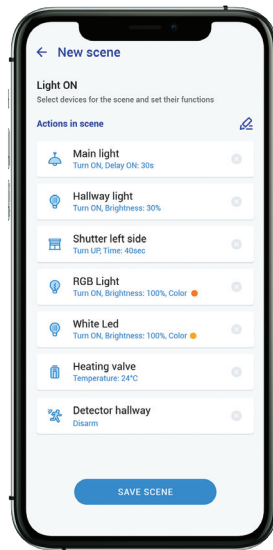

### Scenes

Control multiple devices with one click. Turn off the lights throughout the house or pull out all the blinds, set the right atmosphere for watching TV. Set up your scenes.

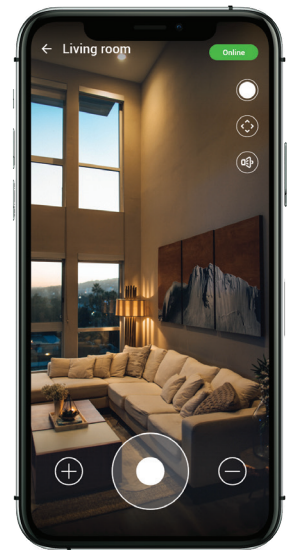

### Cameras

Live monitoring of your home or office, inside and even outside. Be secure at every moment. You can use HIKVISION cameras or any other with RTSP or MJPEG protocol.

## Ready functions

### Electroinstallation

- Lighting control
- Shutter, blind
- Garage doors and gate
- Switching appliances
- RGB bulbs and LED strips
- Scenes
- Automation

### HVAC

- Heating
- Cooling

### Security

- Detectors/sensor
- Camera

### Voice assistant

- Google Home
- Amazon Alexa

### 3RD Party

- Weather station (3<sup>RD</sup> Party)
- Intercoms (3<sup>RD</sup> Party)
- Home appliances (3<sup>RD</sup> Party)
- Air conditioning (3<sup>RD</sup> Party)

### Automatization

- Rule engine

### Other

- User management
- Notification

### Coming soon

- Tablet version (Other)
- Energy dashboard (Energy) (Energy)
- History report (Energy) (Energy)

# Open topology with new possibilities

iNELS BUS comes with a progressive system architecture using the IP protocol.

Evolutionary change in the structure of the connection to the collection system and iNELS BUS, it is only possible to use the IP protocol to connect individual central units and the collection points connected to them. The new IP infrastructure brings about the full potential of using collection points in small, medium and very large installations.



## MiniCU Family

Unlike the previous version of iNELS BUS, where all buses were connected via EBM to one central unit, in the new structure each bus is fully autonomous thanks to the minified version of the central unit (CU3-07 / 08M / 09M / 10M). MiniCU (short name for single-module central unit) is a full-fledged central unit that controls only 1 or 2 buses with additional bus EBM/Dali/Modbus. The main difference is that full functionality is maintained even if communication with other units is lost, so that all units connected to the miniCU remain interconnected, including all predefined links. After the connection with the superior units is re-established, the centrally controlled functions will only be synchronized and restored.

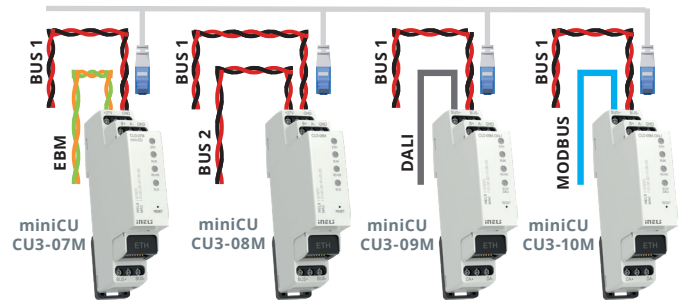

	CU3-07M	CU3-08M	CU3-09M	CU3-10M
BUS1	✓	✓	✓	✓
BUS2		✓		
EBM BUS	✓			
DALI BUS			✓	
MODBUS				✓

## One central unit even for large installations

Centrally controlled functionalities are provided by the master central unit IP-MASTER. The „IP master“ clearly defines how this central unit is connected to the autonomous MiniCUs using the IP protocol. With a commonly used Ethernet speed of 100Mbps and the possibility of asynchronous communication, the connection capacity between the IP-MASTER and the slave miniCUs is greater than in the previous version of iNELS BUS. Thanks to this, we can connect the IP-MASTER to a much larger number of slave buses at the same time.

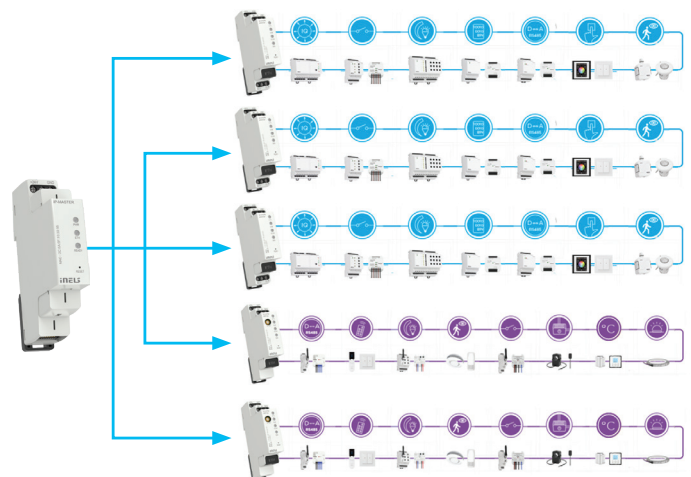

## MQTT in Central units for easy integration and control

To keep the integration simple, we have implemented MQTT communication in all our central units. Since it is industry protocol with a fast response time, it makes the interaction between devices efficient, whatever the number of devices there is. We used MQTT as a light and energy-efficient communication protocol in our BUS and wireless solution. This allows to use data and logics from iNELS units to send it to the other system with real-time.

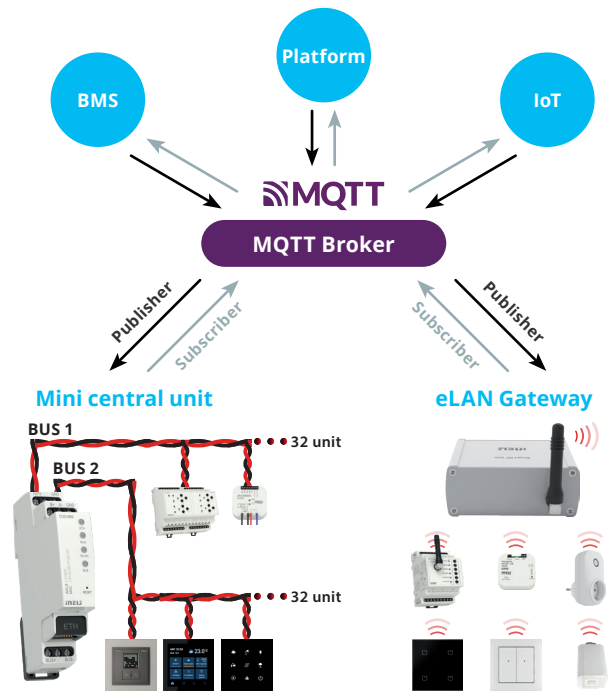

## Central supervision & global conditionality

The new IP infrastructure consists not only in the connection between the MiniCU and the IP-MASTER central unit, but also in the connection to the central iNELS CLOUD system. Using the cloud, it is possible to connect, individual Central units, IP-MASTER units with all their subordinate units, buses and elements. This creates not only the possibility of unlimited scaling of the iNELS BUS system, but also the possibility of creating interrelated functions, where the control element on one installation can control the actuators on a geographically remote installation controlled by another Central unit or eLAN gateway. In addition, iNELS CLOUD offers the possibility of creating conditions linked to external third-party systems or within the system.

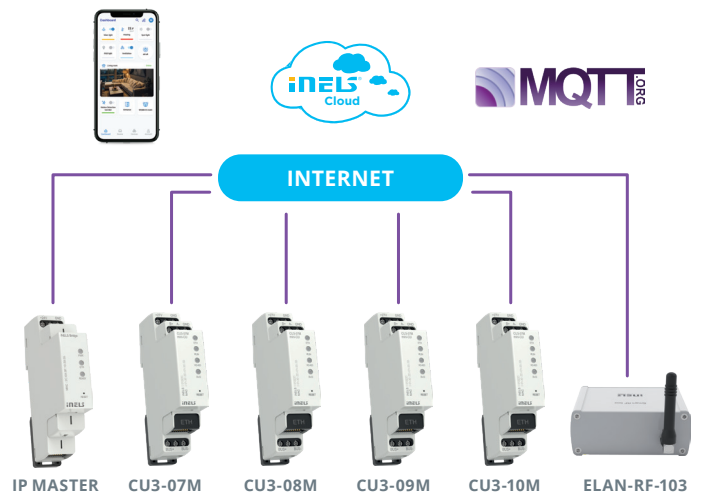

## iNELS Bridge

The new IP infrastructure also includes the option of connecting iNELS central units (wired/wireless technology) and newly implemented third-party integration control unit iNELS Bridge. With the help of iNELS Bridge, it is possible to integrate almost the entire iNELS portfolio, including third-party devices that can be connected using the open Home Assistant platform. iNELS Bridge is also pre-installed with Connection server and Asterisk for 3rd party integration.



# iNELS: Topology

## APPS

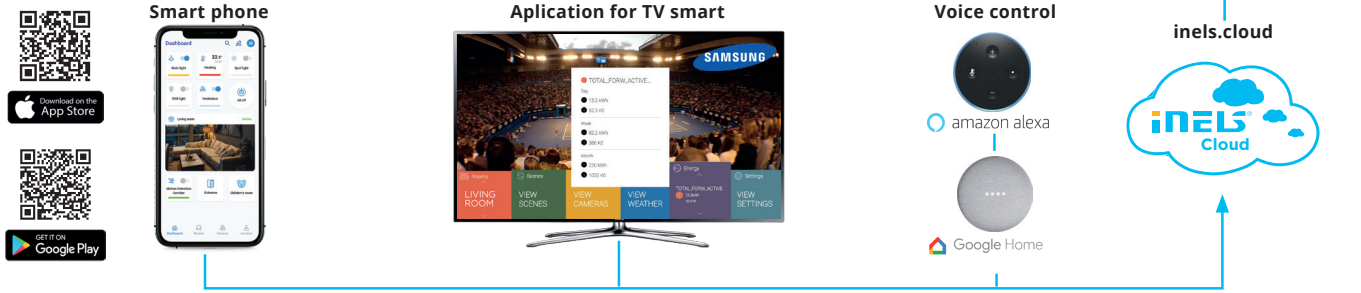

## CU3-107M | BUS 1 EBM BUS

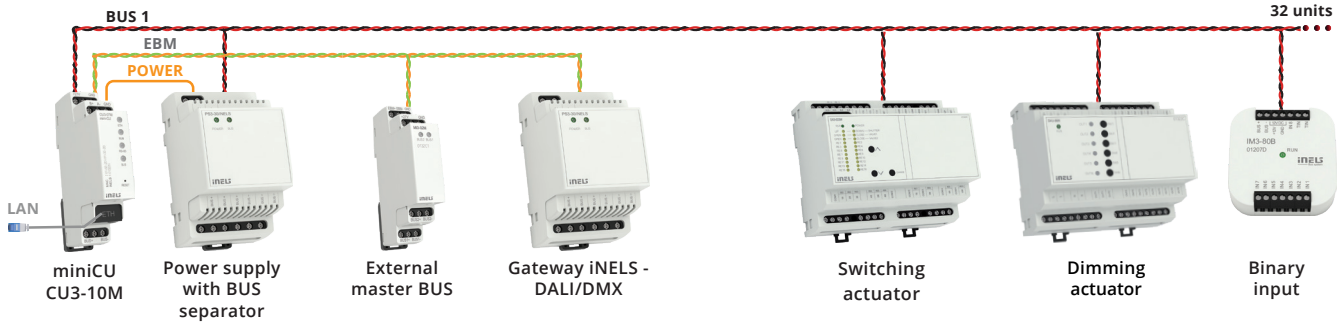

## CU3-08M | BUS 1 BUS 2

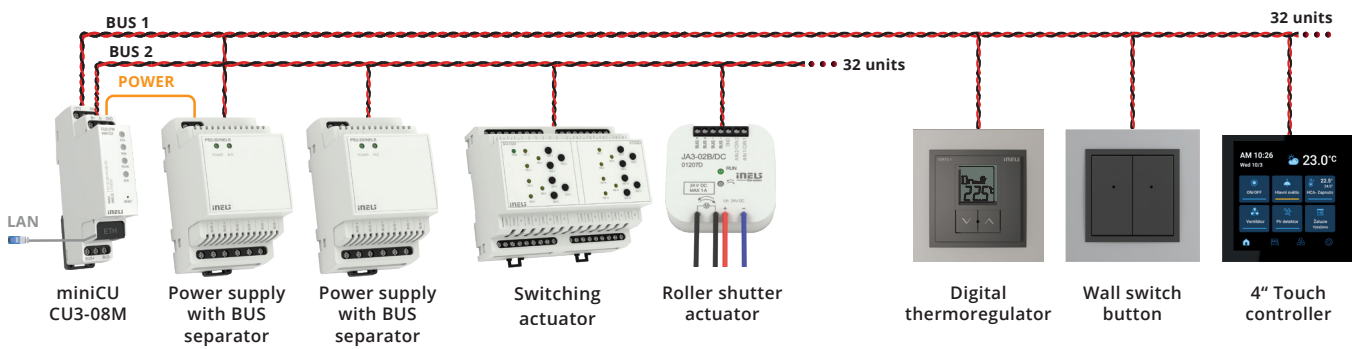

## CU3-09M/DALI | BUS 1 DALI

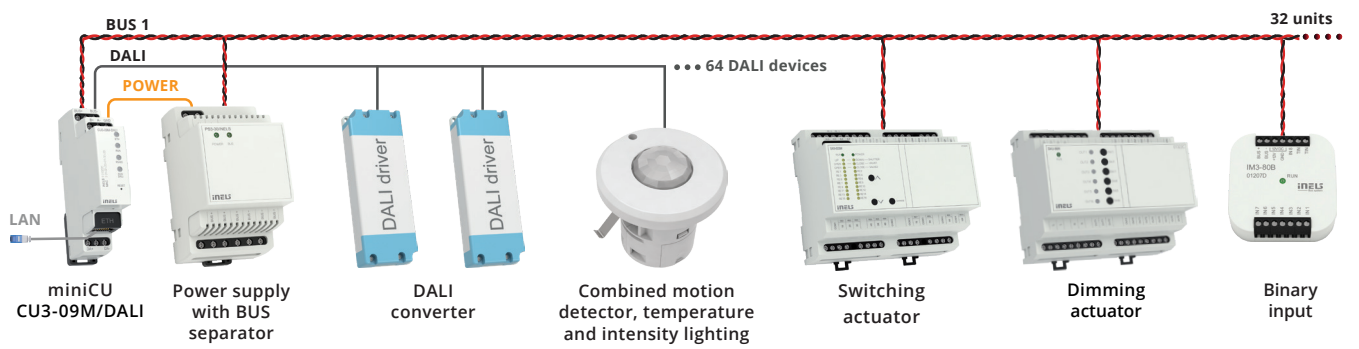

## CU3-10M | BUS 1 MODBUS

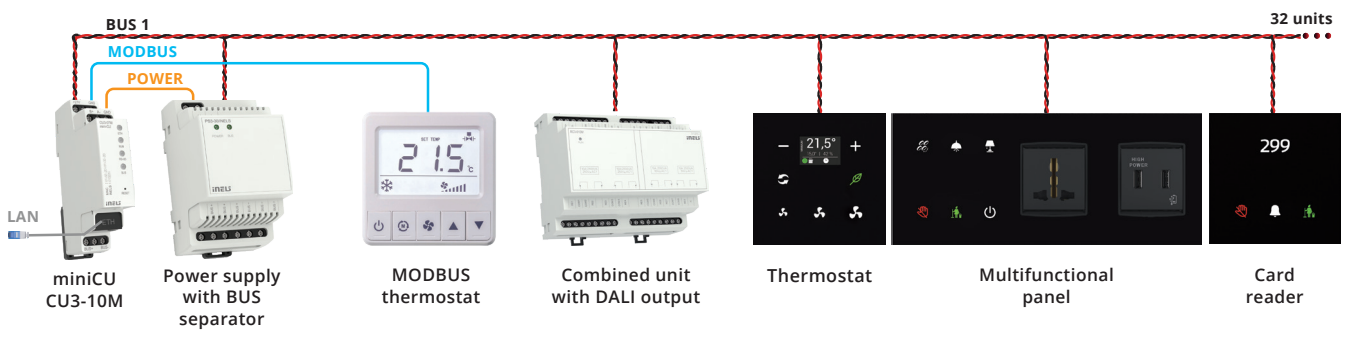

## eLAN-RF-104 | RADIO 868 Mhz



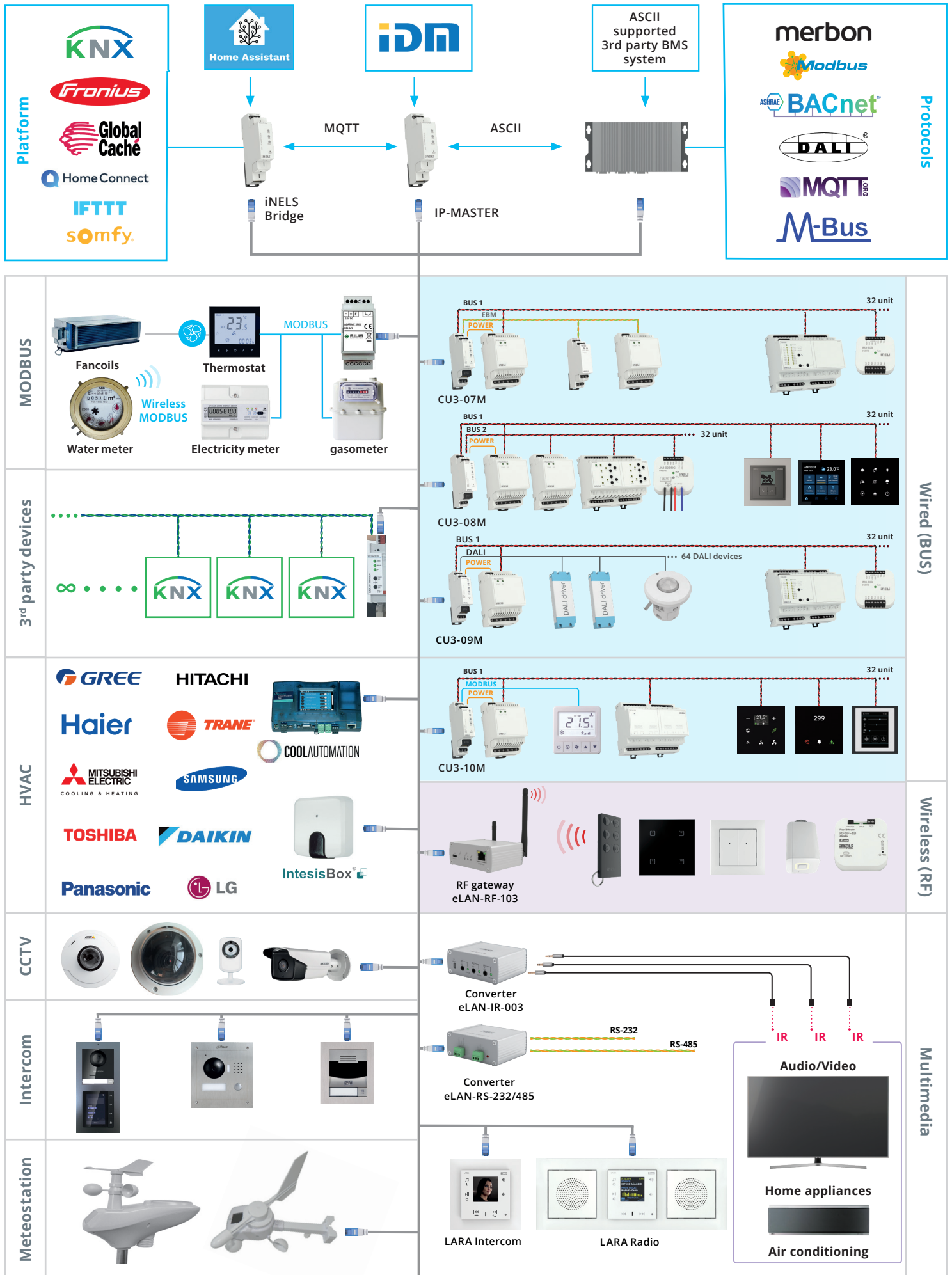

# Wall touch panel with smart functions



The RF Touch-2 wall touch unit is a central element for controlling heating, switching electrical appliances and equipment, dimming lights or controlling blinds and detectors.

It includes a temperature and humidity sensor for the thermostat function. It sends and receives commands from the elements and displays everything on a four-inch capacitive display.

The room temperature can be adjusted using a digital thermoregulator and the device is also able to create cooling circuits.

RF Touch-2 allows quick control and creation of scenes that perform the required actions on the set devices. For example, it can simultaneously close blinds and dim lights in the living room.

The touch unit is fully compatible with the iNELS mobile application and can be connected to iNELS CLOUD.

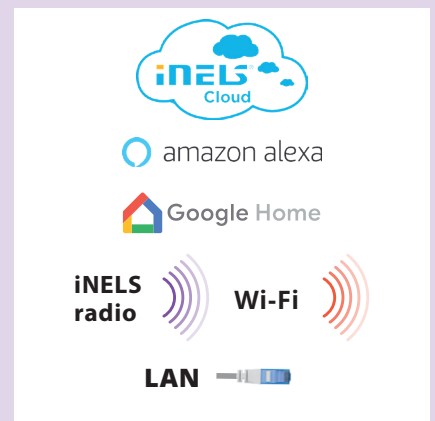

## New display

## New construction

## New functionalities

	New (RF Touch-2/B)	Curent (RF Touch-B)		New (RF Touch-2/B)	Curent (RF Touch-B)		New (RF Touch-2/B)	Curent (RF Touch-B)
Display type	capacitive	resistive	Smaller frontside outlines	86 × 86 mm	94 × 94 mm	Communications	Radio + Wifi + LAN	Radio
Touch point	multitouch	single touch	Smaller backside outlines	43 × 46 mm	50 × 50 mm	Sensors	temp + humidity + ambient + proximity	temperature
Resolution	480 × 480 px	320 × 240 px	Easier installation	separate metal wall holder + display to snap-in to holder	base flushed mounted + display with pins to fit to holes	Gateway (eLAN-RF)	included	-
Diagonal	4"	3.5"	Power connections	USB-C & terminals & PoE	terminals only	Connection to Cloud	yes	no
Display colors	64 million	262.000	Consumption	3W	5W	UX/UI	variable	fix
						Setup possibility	free, via the iNELS Cloud	fix

## Easier installation iNELS RF

# The units are newly equipped with screw-less terminals

The modernization of the switching units consists in the replacement of components - the classic screw clamp is replaced by a screw-less terminals.

While the power supply wires have previously had to be screwed to the device, the new technology makes the connection easier: the clamp allows quick connection by simply inserting the wire into the device. In the screw-less terminal, the conductor is pressed by a spring against a fixed, non-moving part, the pressure on the conductor is constant throughout the life of the product. The connection is very tight and reliable.

Removal of the conductor or any adjustments are just as easy as installation. Both rigid and flexible conductors of appropriate cross-sections can be connected to the device.

The new unit design has additional advantages thanks to innovation: using elements without lead wires creates more space in the installation box and makes the overall installation clearer.

In the case of actuators that have one input/output, the power supply terminals are intentionally doubled, so there is no need for additional external connection terminals in most installations.

The innovation guarantees a firm and stable connection.

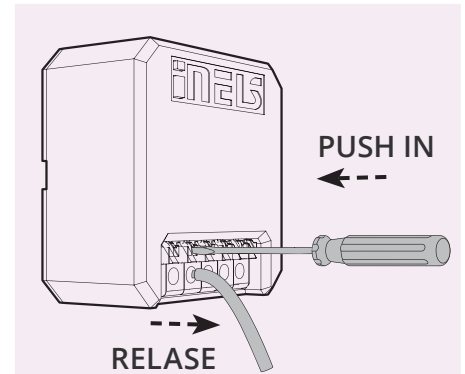

Upgraded switching elements of these types:

- RFSAI-11B-SL
- RFSAI-62B-SL
- RFSTI-11B-SL
- RFJA-32B-SL
- RFDEL-71B-SL

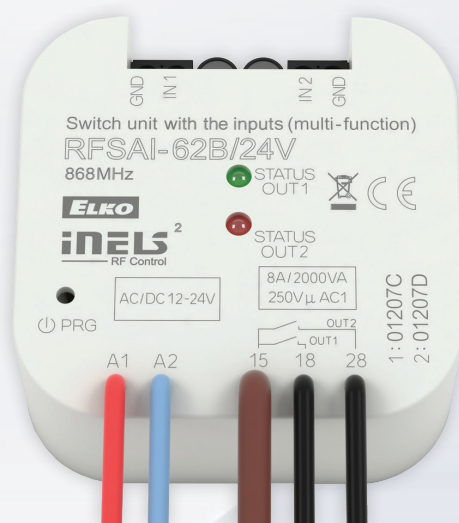

Previous product



**Screwless terminals for faster wiring**



New product

## Smart Kits

# First step to a Smart Home

It is a starter kit for every household, it is an easy and fast solution for typical cases of home use, such as moving a wall switch, equipping common lights with dimming functions, remote control of blinds and shutters, advanced heating control and basic home security.

Mainly, it is a set of one controller (e.g. wall controller) with an active unit (e.g. switch), which is ready for immediate installation. Although the kits are design as "preprogramed plug-&-play" and their installation can be done by a buyer-themselves, it is still a professional product, which should not be compared to a "hobby" production.

iNELS smart kits are the basis of your new smart home.



iNELS Smart kits  
[smartkits.inels.com](http://smartkits.inels.com)

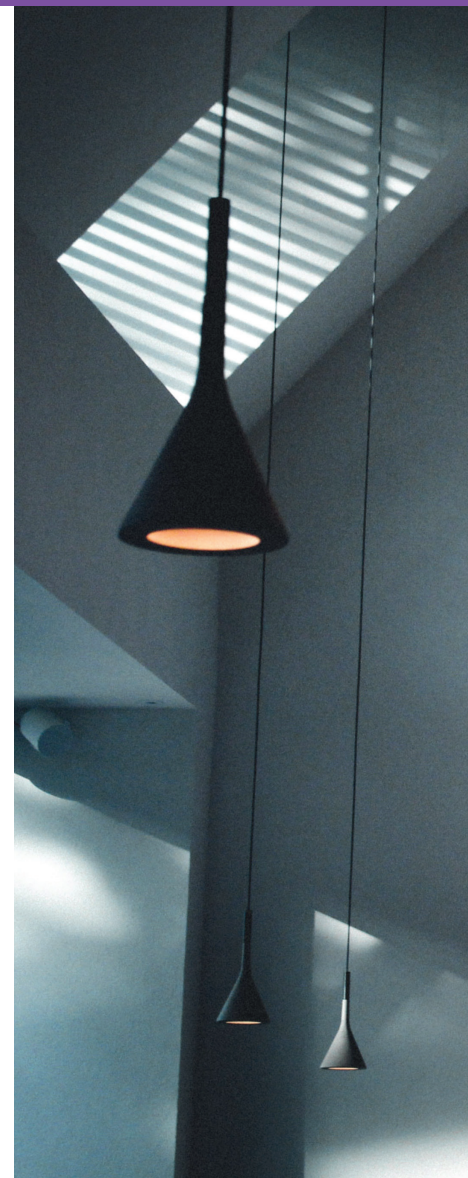

### Wireless switch

Combinations of wireless controllers and switch units for universal use. It is used to control electrical appliances, lights, sockets, garage doors, etc.



### Wireless socket

Combination of wall wireless control and switching socket-plug for universal use. This kit transforms an ordinary socket into controlled one. Turn the light and other devices on or off or make time schedule of switching will be easier than ever before.



### Light comfort

Combinations of wireless iNELS controller and universal dimmers to control the lighting level. They can be installed in existing lighting circuits or dimmable plug-in lamps.





### Blinds within reach

Combinations of wireless iNELS controllers and switch units for shutters. For those who have electrically operated blinds / shutters and want to control them wirelessly.



### Easy heating control

Combination of Touch panel and wireless thermostats for easy heating control.



### iNELS Smart House

A smart house can handle many routine tasks for you. It can set everything itself based on the data, but it is always you who controls.

# Combination of iNELS devices

## Switching, Dimming

### Controllers

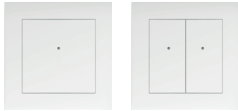

- On-wall button controllers (2 or 4 buttons)



- Luxury (glass) wall controller (2 or 4 buttons)



- Key fob controller (4 or 6 buttons)



### Receivers



- Switch unit
- Universal dimmer



- Switching socket - plug
- Dimming socket - plug



French



Schuko



British

### Glass wall controller



Black



Round or sharp



White

## Temperature control

### Controllers



- Wall Thermostat
- Autonomous temperature controller



- Touch panel
- Smart control unit
- Wall installation



- Smart RF Gateway



### Receivers



- Multifunction switch unit
- Switch unit with an external temperature sensor



- Wireless Thermo-valve



- Boiler switch

### Touch panel



Wall-mounted central panel with smart box functions

## Shutters & Blinders

### Controllers



- On-wall button controllers (2 or 4 buttons)



- Luxury (glass) wall controller (2 or 4 buttons)



- Key fob controller (4 or 6 buttons)



### Receivers



- Shutters switches RFJA-32B-SL

### iNELS App

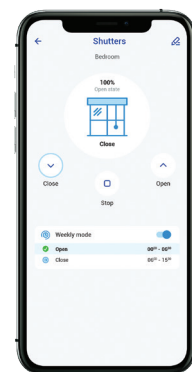

Control your shutters via mobile phone

# Smart Expandable System

## Point to Point

### End User

Individual elements of the iNELS system for personalised installation.

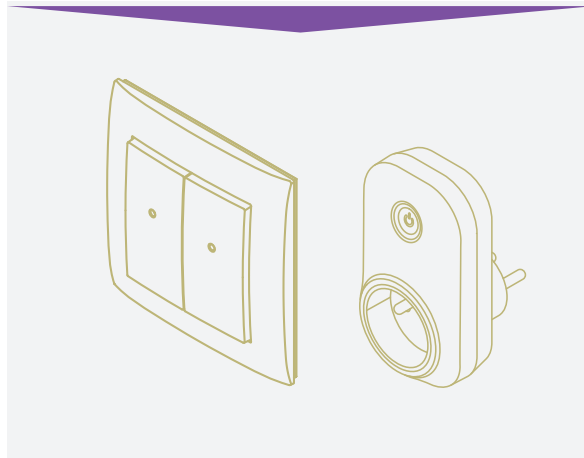
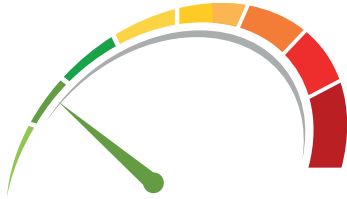

## Kits

### Hobby Man

Pre-Set elements for everyday applications.

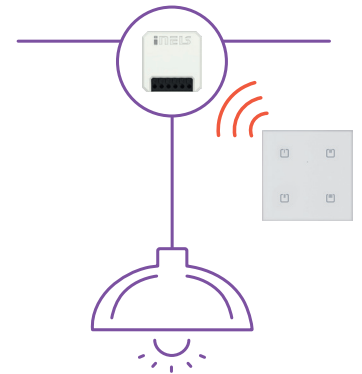
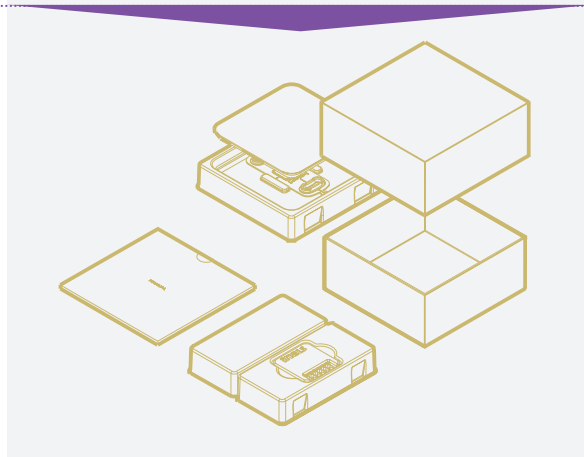
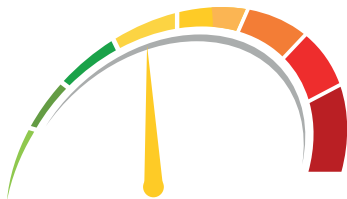

## Connected Home

### Electrician

A simple solution to turn your house into a smart home, without any structural intervention.



## Smart Home

### System Integrators

When using wireless elements is faster and cheaper.

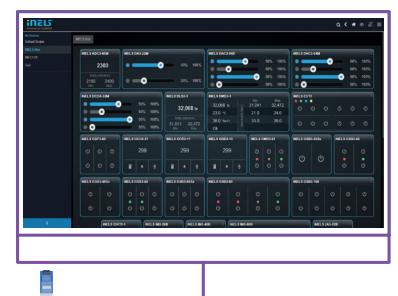
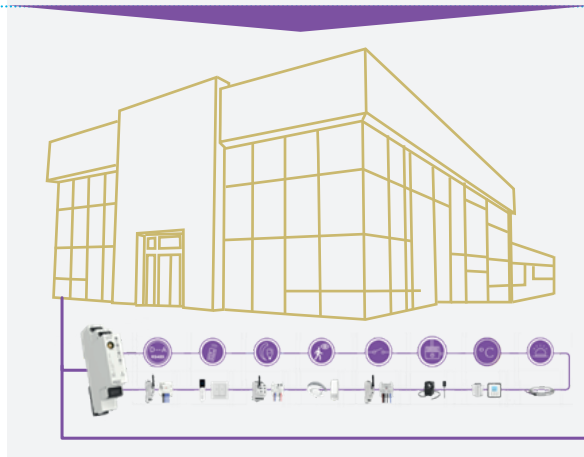

# All what you need for your SMART home, office, building, ...

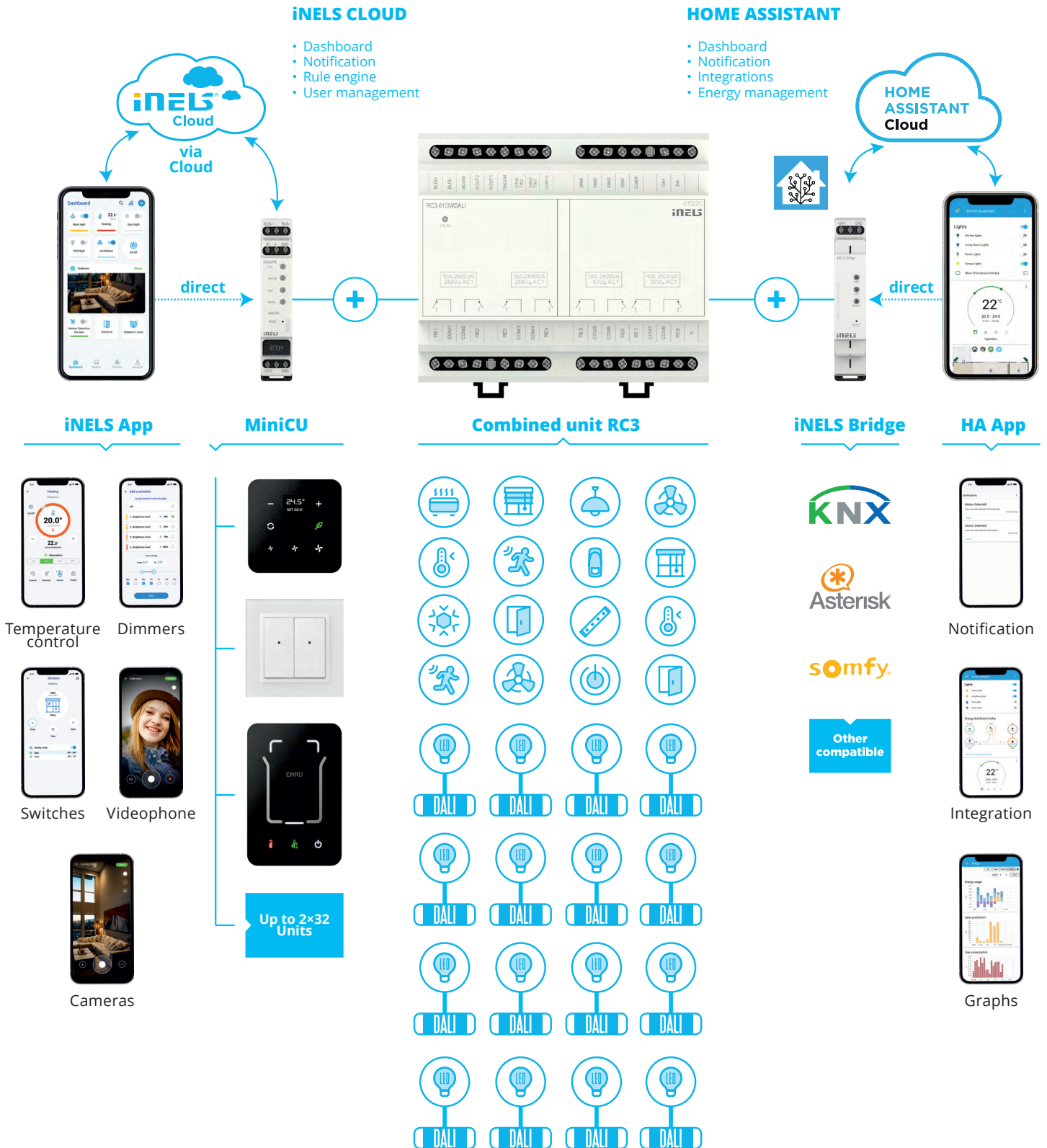

# Unlimited control options



While the definition of the “cloud” may not be entirely clear, in principle it is the term used to describe the global network of servers, each of which has its own function.

iNELS Cloud uses the support of one of the largest providers of these services, specifically the Cloud service DigitalOcean. This provider has 14 data centers located around the world, and as such can guarantee almost 99.99% stability of its services which at the moment accounts for more than half a million users.

Users of smart homes or larger automated installations can control their RF or BUS devices remotely without the need to own a public IP address that would allow them to remotely access the installation.

Thanks to the outsourcing of data to the cloud, the possibility for integration and interconnection has been created for a much wider range of third-party devices that will make the system user experience more enjoyable to use. For example, the voice control that is available in The Google Home or Amazon Alexa apps.



∞ GB  
memory

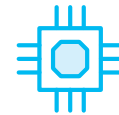

∞ CPU  
number of cores



∞ GB  
storage

Thanks to these unlimited parameters ELKO CAN provide cloud connectivity to its customers all over the world and all this completely free of charge.

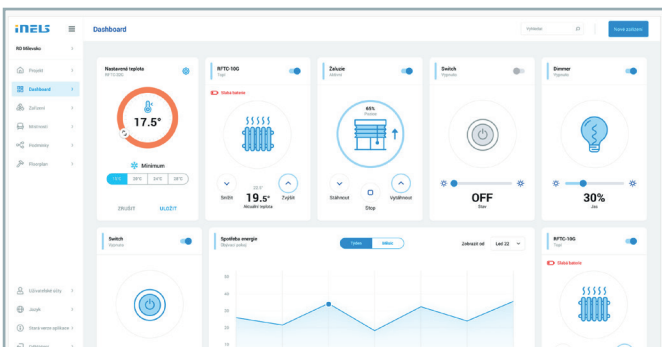

## Dashboard

The dashboard allows you to configure your own display for control. It is possible to insert elements from any gateway that is connected to the cloud.

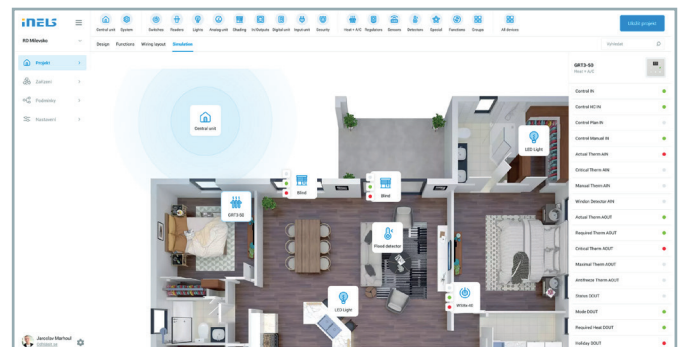

## Configuration and control

Elko cloud has control and configuration of installations not only through the iNELS mobile application, but also the new web interface.

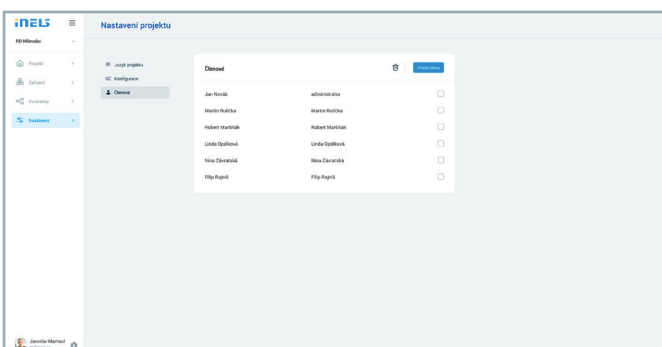

## User management

User management allows detailed control over the usage of entire installations for individual users. By setting up rules there can be almost no limit to different configuration options.

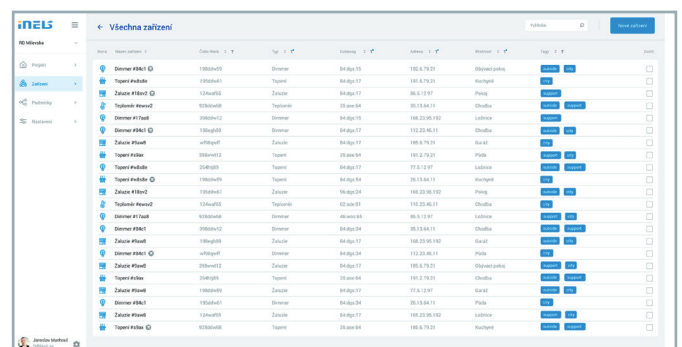

## Manage all devices

The cloud allows you to manage installed devices in one place. The list of devices can be filtered and configured by specific basic parameters.

# Timers / Relays



## Multi-function time relays (SL)

CRM-91H-SL, CRM-93H-SL

- easy & fast connection using screw-less terminals
- similar to our current CRM-91H, CRM-93H with UNiversal voltage AC/DC 12 - 240V
- cross-wire section (solid): 0.2 mm<sup>2</sup> - 2.5 mm<sup>2</sup> (AWG 24 - 14)



## Multi-function voltage monitoring relays (1-phase, AC/DC)

HRN-31, HRN-32/2, HRN-39

- each type with 9 functions (including memory)
- similar range as single-function types but with DC as well:  
HRN-31 replaces HRN-33 (AC/DC 48 - 276V)  
HRN-32/2 replaces HRN-35 (AC/DC 48 - 276V)  
HRN-39 replaces HRN-37 (AC/DC 24 - 150V)
- TRUE RMS, for precise measuring



## Multi-function voltage monitoring relay (1-phase, DC)

HRN-36

- each type with 9 functions (including memory)
- wider range for overvoltage than the previous single-function type, which now support 12V batteries:  
HRN-36 replaces HRN-34 (DC 6-30V)
- TRUE RMS, for precise measuring



## Multi-function current monitoring relay (1-phase, AC)

PRI-34

- 8 functions (including memory)
- power supply and monitoring circuits are not galvanically separated
- TRUE RMS, for precise measuring
- possibility to extend the range using an external current transformer



## Monitoring relays (voltage, current, temperature)

HRN-42, PRI-42, HRN-43/43N, TER-4

- new galvanically separated UNiversal power supply AC/DC 24 - 240V, alternatively fixed power supply AC 230V or 400V
- existing types:  
HRN-42 for monitoring voltage (1-phase, AC/DC)  
HRN-43 & HRN-43N for monitoring voltage (3-phase, AC)  
PRI-41 for monitoring current (1-phase, AC/DC)  
TER-4 for monitoring temperature (2-in-1)
- wide range and two output contacts providing more options of setup

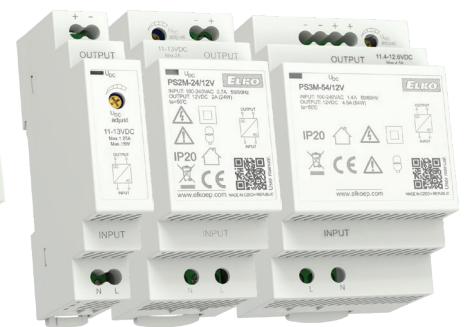

## Power supplies (15V, 24V, 54V, 85V)

PS1M / PS2M / PS3M / PS4M

- adjustable output for voltage drop compensation, high load in small design output voltage 12 or 24 V
- switching stabilized power supply with output voltage 12 or 24 V DC
- high efficiency up to 90%.
- low ripple and noise.

# SHT-13 | Multi-function time switch

## All in One

Daily, weekly, yearly and astronomical program.

Digital time switch is device that has an inbuilt electronic timer to control an electrical circuit by turning ON & OFF at a preset time. These switches generally used in different areas like residential & commercial buildings, gardens, schools, fountains, water pumps or irrigation, offices, lighting indoor or outdoor, ventilation systems & other types of devices that need to be controlled throughout the day. A timer switch can save money on energy costs, improves home comfort and makes life more convenient.

### Features & benefits

- UNiversal voltage range AC/DC 24 – 240 V (AC 50/60 Hz)
- Simple setting after the first start-up
- Replaceable battery for power back-up (<1 minute to replace battery without losing data)
- Web setup and control via Wi-Fi connection (2.4 GHz)
- New well-arranged display with white backlight
- 2-channels (each with an hour counter)
- Pulse/Cycle output mode
- Transition of summer/winter time – AUTO or OFF
- Sealable transparent front panel cover



## Configuration and control using the web interface

Thanks to the integration of the Wi-Fi module, it is possible to wirelessly set and control the time switch with a computer or phone. Possibility to create an access point gives the time switch advantage, that there is no need for additional equipment, e.g. a router, which would otherwise mediate the communication.

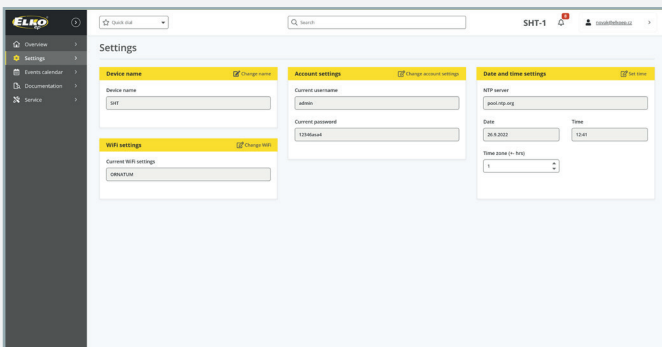

### Settings

Here, we are able to change the current settings of the time switch such as its name, user account, date and time using NTP server, operate backup and restore and many more...

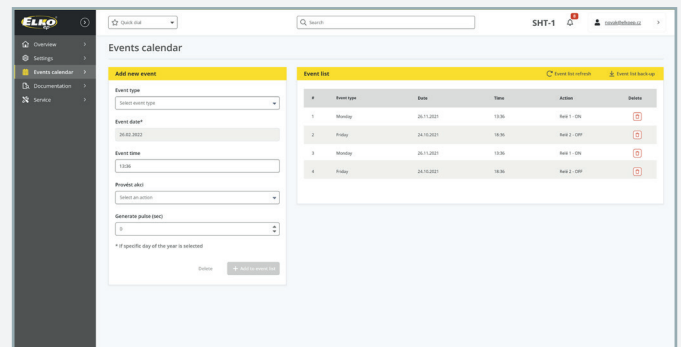

### Events calendar

Basic commands such as turning connected load ON and OFF, to more advanced ones like pulse output, astronomical program settings, vacation mode, and more...

# Wired (BUS)



## Superior central control unit

### IP-MASTER

- the IP-MASTER central unit is a high-performance control unit designed for controlling subordinate units compatible with the iNELS IP protocol
- IP-MASTER is designed for fully autonomous control of even very large projects consisting of 1000+ subordinate central or system units
- the iNELS IP protocol also allows the use of the iNELS mobile application to control all devices included in the project



## Central unit with 1x iNELS BUS, 1x EBM CU3-07M

- Cu3-07M is one of the basic system control units of iNELS BUS installations
- the unit can work independently, as an autonomous project, or it can be controlled by the IP-MASTER central unit as part of a larger project
- the unit is equipped with one BUS to which it is possible to connect up to 32 elements from the iNELS BUS portfolio
- And one EBM bus to connect Dali/DMX gateway EMDC-64M
- The central unit comes with cloud connection and MQTT protocol



## Central unit with 2x iNELS BUS CU3-08M

- CU3-08M is one of the basic system control units of iNELS BUS installations
- the unit can work independently, as an autonomous project, or it can be controlled by the IP-MASTER central unit as part of a larger project
- the unit is equipped with two BUS, to which it is possible to connect a total of up to 64 elements (2x32) from the iNELS BUS portfolio
- The central unit comes with cloud connection and MQTT protocol



## Central unit with 1x iNELS BUS, 1x DALI CU3-09M/DALI

- CU3-09M/DALI is a special version of the mini-fied central unit and is designed to control DALI electronic ballasts from the iNELS system
- the unit can work independently, as an autonomous project, or it can be controlled by the IP-MASTER central unit as part of a larger project
- up to 32 elements from the iNELS BUS portfolio can be connected to the BUS system
- The central unit comes with cloud connection and MQTT protocol



## Central unit with 1x iNELS BUS, 1x MODBUS CU3-10M

- Cu3-10M is one of the basic system control units of iNELS BUS installations
- the unit can work independently, as an autonomous project, or it can be controlled by the IP-MASTER central unit as part of a larger project
- the unit is equipped with one BUS to which it is possible to connect up to 32 elements from the iNELS BUS portfolio and one Modbus system bus to connect modbus devices. branch, from which the iNELS peripheral units are further supplied
- The central unit comes with cloud connection and MQTT protocol



NEW

## Bridge to 3rd Party Integration iNELS Bridge

- iNELS bridge works as a gateway for connecting thirdparty devices and integrating them into the iNELS environment
- it is a one module hardware contain powerful linux based computer
- the unit comes with an option of pre-installed Connection server, Home assistant with inels driver and Asterisk
- iNELS bridge is equipped with wifi and ethernet port for fast and easy communication





## Room controller with PHASE dimmers

### RC3-612M

- the unit is designed to control hotel rooms
- the unit is equipped with 6 binary inputs, of which 2 can be configured as temperature inputs and 8 independent relays with switch contacts
- it also includes two analog outputs and two-phase dimmer channels

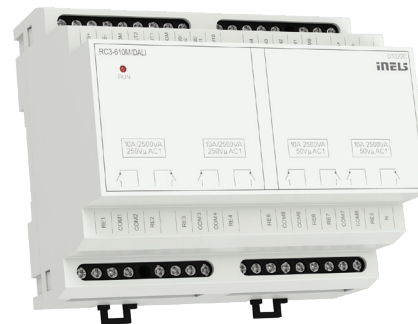

## Room controller with DALI dimmer

### RC3-610M/DALI

- the unit is designed to control hotel rooms
- the unit is equipped with 6 binary inputs, of which 2 can be configured as temperature inputs and 8 independent relays with switch contacts
- It also includes two analog outputs and a bus for controlling up to 16 DALI ballasts

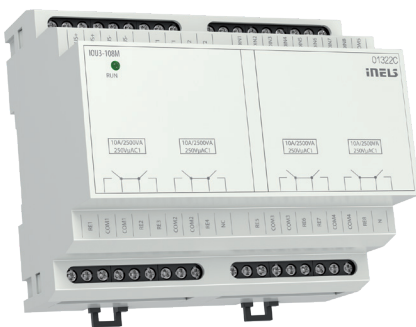

## Dimmer Actuator 6-channel

### DA3-66M

- DA3-66M is a universal dimming 6-channels actuator, which is used to control the brightness of dimmable light sources such as ESL, LED and RLC with 230 V power supply
- the DA3-66M has 6 semiconductor controlled 230 V AC outputs. The maximum possible load is 150 VA for each channel
- each output channel is independently controllable and addressable

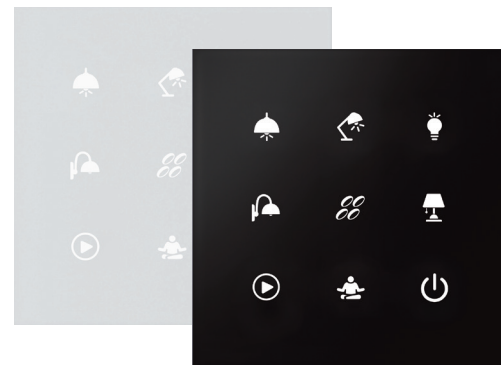

## Glass switch button controllers (sharp edges)

### GSB4-90

- the wall controller with touch control series GSB is a design element in the system iNELS3 with elegant design and comfort controlling
- new GSB4-90 wall controller comes with new design and improved touch control
- controllers are also available in 4 button (GSB3-40), 6 button (GSB3-60)
- controllers are available in black and white colour with symbol or non symbol option

## New products

# Wireless (RF)



### Glass touch controllers 2 or 4 buttons (sharp edges)

#### RFGB-20 / RFGB-40

- the glass touch controller is a design RF (wireless) control unit and is available in elegant black and white variants
- only 8 mm thick

**RFGB-20/B:** 2-buttons, black glass  
**RFGB-40/B:** 4-buttons, black glass  
**RFGB-20/W:** 2-buttons, white glass  
**RFGB-40/W:** 4-buttons, white glass



### Glass touch controllers 2 or 4 buttons (round edges)

#### RFGB-220 / RFGB-240

- the glass touch controller is a design RF (wireless) control unit and is available in elegant black and white variants
- only 8 mm thick

**RFGB-220/B:** 2-buttons, black glass  
**RFGB-240/B:** 4-buttons, black glass  
**RFGB-220/W:** 2-buttons, white glass  
**RFGB-240/W:** 4-buttons, white glass



### Glass controller with dimmer 4 buttons (sharp & round edges)

#### RFDW-71

- wireless glass designed switch with integrated dimming component which serves to regulate light sources:
  - **R** - classic lamps
  - **L** - halogen lamps with wound transformer
  - **C** - halogen lamps with electronic transformer
  - **ESL** - dimmable energy efficient fluorescent lamps
  - **LED** light sources (230 V)

**RFDW-71/B:** 4-buttons, black glass  
**RFDW-71/W:** 4-buttons, white glass

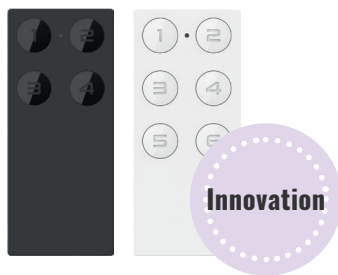

### Key fob 4 buttons, 6 buttons

#### RF KEY-40 / RF KEY-60

- when pressing the button, it sends a set signal (ON/OFF, dimming, time switching OFF/ON, blinds up/down)
- **RF KEY-40:** four buttons enable control of four units independently
- **RF KEY-60:** six buttons enable control of four units independently
- key fob - sized remote control, available in black and white



### Dimming socket-plug

#### RFDSC-71N

- the dimmable socket is used to control the brightness of luminaires that are connected by a power cord with a plug
  - **R** - conventional bulbs (resistive load)
  - **L** - halogen bulbs with winding transformer (inductive load)
  - **C** - halogen bulbs with electronic transformer (capacitive load)
  - **ESL** - dimmable energy-saving lamps
  - **LED** - light sources equipped with LEDs



### Switching socket-plug

#### RFSC-61N

- the switched socket is used to control fans, lamps, direct heaters, and appliances, which are connected by a power cord with a plug up to 16 A
- they can be combined with detectors, controllers, or iNELS RF Control system components
- multifunctional design - button, impulse relay and time functions of a delayed start or return with time setting 2 s - 60 min
- the switched socket can be controlled by up to 32 channels

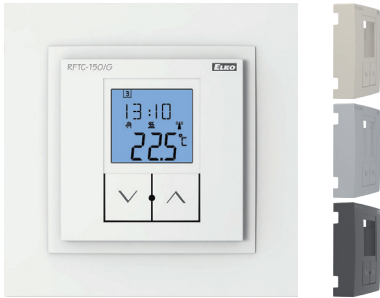

### Thermostat for fancoil control via RFSA-166M RFTC-150/G

- the wireless controller RFTC-150/G in design LOGUS<sup>90</sup> measures the room temperature by internal sensor
- on the basis of a set program it sends commands to the switching component RFSA-166M Switching fan coil
- it is possible to set automatic or manual mode
- range of measured temperature 0 to 55 °C



### Outdoor controller 2 buttons RFOWB-20

- the wireless push-button controller with IP65 protection is used to control iNELS RF components and protect them from the outdoor environment
- 2 buttons allow (independently of each other) control of an unlimited number of components (actuators)
- the controller is suitable for control from the pool, garden, terrace, and pergola. It can be used as an uncovered bell button
- Fastening with screws or double-sided tape



### Wireless thermovalve RFATV-2

- The wireless thermovalve measures the room temperature with an internal sensor and opens/closes the radiator valve based on the set program in the system component
- It can be combined with the eLAN-RF, RF smart box
- It measures temperature in the range 0 to +50 °C and humidity 5-95% and sends it to the system component at regular 2 min. intervals
- „Open window“ detection, when the temperature suddenly closes the valve for a preset time



### DALI converter RFDALI-32B-SL

- the RFDALI-32B-SL converter is designed to control devices with a DALI interface, such as dimmers, electronic ballasts, LED converters and more
- the control is performed by components from the iNELS RF Control system, detectors, controllers or system devices
- Assignment and configuration of DALI devices is performed via the application via the Bluetooth interface



### Universal dimmer, 6-channels RFDEL-76M

- the RFDEL-76M is a universal six-channel dimmer that is used to control the brightness intensity of dimmable R - L - C - ESL - LED ESL sources
- the maximum possible load is 150 VA for 230 V and 75 VA for 120 V for each channel
- individual dimmer channels can be connected in parallel to increase the maximum output load at the expense of the number of outputs
- each of the output channels is independently controllable and addressable



### Input contacts converter RFIM-40B/BP-SL / RFIM-40B/230-SL

- converts 4 potential-free inputs that can be closed for a short time (buttons) or permanently (switch, contact) on the RF signal
- range up to 200 m (in open space)

**RFIM-40B / BP-SL:** battery supply (CR 123A)  
**RFIM-40B / 230-SL:** mains supply (AC 230V)

## References

# iNELS for everything, everywhere



### STROM Offices Czech Republic / Pilsen

- model of serviced private offices and shared office space tailored to individuals or small start-ups
- controlling lighting, blinds and heating, all integrated with the access control system



### Private Villas Middle East / Kingdom of Jordan

- three residential villas in the country capital Amman
- outdoor and indoor lighting controlled by wall-mounted glass touch controllers
- iNELS BUS GSB3 series controllers

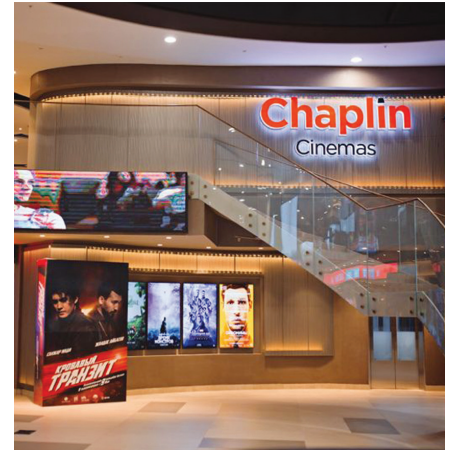

### Multifunctional centre Kazakhstan / Almaty

- Hotel Kempinski, Chaplin Cinemas multiplex, luxury restaurant
- lighting control in the reception, corridors, social and conference rooms
- group of CU3-02M central units - the brain of the central hotel solution



### Riyadh Metro Saudi Arabia / Riyadh

- protection for tunnel ventilation fan in underground stations
- TER-7 - thermostat for monitoring temperature of motor winding
- 188 pieces in 12 metro stations



### Family House Czech Republic / Břeclav

- comprehensive installation of the iNELS BUS system in a family house
- control of all indoor and outdoor lights with emphasis on RGB lighting
- power windows, including blinds, curtains and drapes, heating control, and integrations of security system

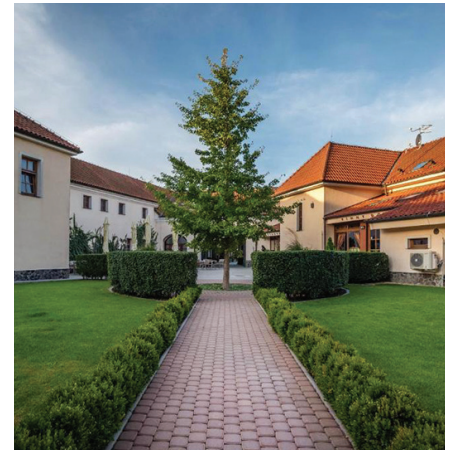

### Hotel Chateau Slovakia / Krakovany

- hotel Chateau in the area of the world-famous Slovak spa Piešťany
- smart heating control of all hotel areas



### SPA hotel NEMO

Ukraine / Odessa

- luxury and comfort thanks to smart technology iNELS BUS
- the air conditioning, lights and the fire system in hundred hotels rooms it is the project scope
- the basic element is the control of Mitsubishi HVAC with a support of hotel thermostats GRT3 and iNELS glass touch controllers



### Mashroat Office

Saudi Arabia / Riyadh

- the headquarters of government company Mashroat Office - The National Project Management, Operation and Maintenance Organization
- The lighting control of the conference facilities and corridors divided into 8 rooms and 32 dimmable circuits



### Astronomical clock

Slovakia / Stará Bystrica

- the most accurate astronomical clock in the world
- The astronomical part consists of an astrolabe showing the signs of the zodiac, the position of the sun and moon and the moon phases.
- for a perfect impression lighting is needed and it is timed using CRM-91H element



### Kuwait Society of Engineers

Kuwait / Bneid Al Qar

- KSE is one of the leading institutes in Kuwait where it holds more than 5 thousand engineers serving various government and private sectors
- iNELS has installed a combination of BUS & RF solutions to control lighting, blinds, and shutters
- KSE is one of the strategic supporters of iNELS and working together on other technological projects.



### Boyko Author School

Ukraine / Kharkiv

- modern classroom equipment of the summer campus of the most prestigious private school
- sensor-controlled lighting level on the bench workspace and automatically adjustable lighting brightness controlled by DALI adapters. controlled energy consumption regulated by motion detectors

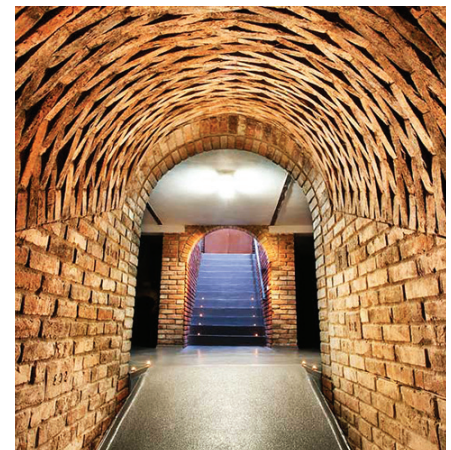

### Janoušek Winery

Czech Republic / Rakvice

- Janoušek family winery in one of the most famous wine production locations
- lighting and heating control in presentation areas
- iNELS BUS system using central unit CU3-01M, dimming actuators DA3-012M, switching actuators SA3-012M and wall controllers WSB3-40

ELKO EP

# Made in Czech Republic

We have been your partner in the field for 30 years, manufacturing and developing the highest quality electrical devices.

ELKO EP employs 330 people across 15 foreign branches that exports its products to more than seventy countries. Company of the Year of the Zlín Region, Visionary of the Year and Global Exporter of the Year are just some of the awards we have received throughout the years as we consistently strive to move forward in the field of innovation and development.

Millions of relays, hundreds of smart homes and thousands of satisfied customers. This is ELKO EP; a traditional company based in the center of Europe, where development, production, logistics, and service are at the forefront of our focus. Building automation systems, smart city facilities and the Internet of Things (IoT) devices are solutions we can offer.



## Other just resell

However, we develop and manufacture products ourselves!

### Developers

In the new R&D center, more than 30 engineers develop new products and extend the functionality of existing product.

### Producers

Modern antistatic spaces, 2x fully automated SMD production lines with 2 shift operations.

### Support





24 hours / 7 days / 360 days, logistical as well as technical.

### Sellers

Personal access to more than 70 sales representatives in ELKO EP Holding providing impeccable services and superior products at an affordable price.



The world is changing at every moment and we are ready for it. We develop, modernize, expand and constantly grow.

 About ELKO EP	<b>30 years</b> on the market	<b>20 years</b> ISO certification	<b>330</b> Employees
 Reasonable split	<b>30%</b> Czech	<b>40%</b> Export	<b>30%</b> Branches
 Worldwide presence	<b>10</b> Branches	<b>6</b> Franchises	<b>70</b> Exporting countries
 Our figures	<b>16 500</b> iNELS installation	<b>600 000</b> Products per year	<b>13 mio</b> All products
 In house production	<b>3</b> SMD lines	<b>3</b> Printing lasers	<b>2000m<sup>2</sup></b> Manufacturing space

## Constant innovation

The highest products quality and their constantly expanding functionality rank us among the world leaders.



