

# SMART WIRELESS ELECTRO-INSTALLATION

[TECHNICAL CATALOGUE](#)



# ELKO EP



**We are traditional, innovative and purely Czech development manufacturer of electronic devices and we have been your partner in the field of electroinstallations for 26 years.**

ELKO EP employs about 330 people, exports its products to more than seventy countries, and has representatives in thirteen foreign branches. Company of the Year of the Zlín Region, Visionary of the Year, Global Exporter of the Year, Participation in the Czech TOP 100, these are just some of the awards received. Still, we are not finished. We are constantly striving to move forward in the field of innovation and development. That's our primary concern.

Millions of relays, thousands of satisfied customers, hundreds of our own employees, twenty six years of research, development and production, thirteen foreign branches, one company. ELKO EP, innovative - a purely Czech company based in Holešov, where development, production, logistics, service and support go hand in hand. We primarily focus on developing and manufacturing systems for building automation in the residential, commercial and industrial sector, a wide range of Smart city facilities and the so-called Internet of Things (IoT).



# Facts and stats

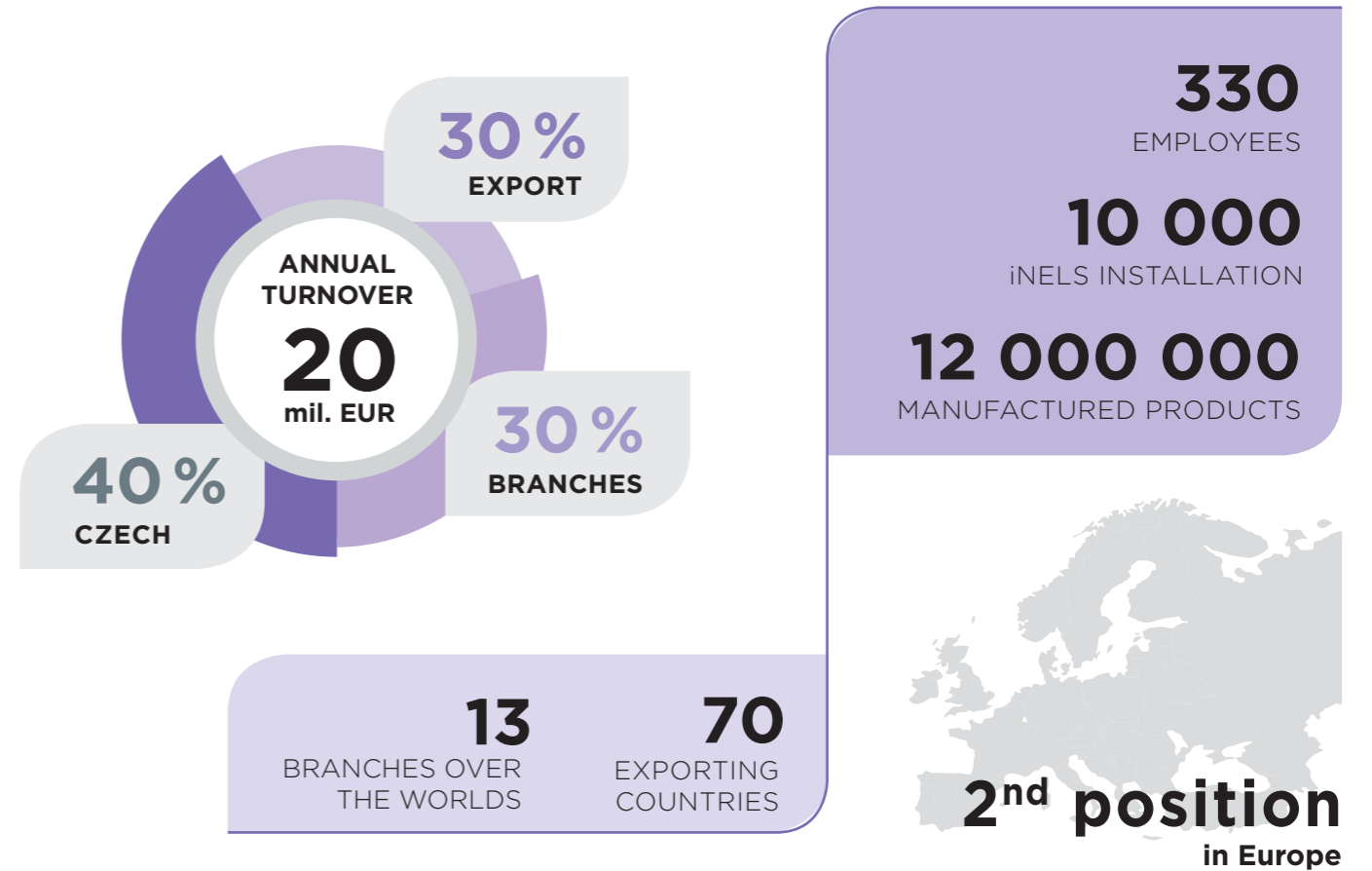

## WE ARE

<p><b>DEVELOPERS</b></p> <p>In the new R&amp;D center, more than 30 engineers develop new products and extend the functionality of existing products</p>	<p><b>PRODUCERS</b></p> <p>modern antistatic spaces, 2x fully automated SMD production lines, 2 shift operations.</p>	<p><b>SUPPORT</b></p> <p>24 hours / 7 days / 360 days we not only provide technical support but also logistics.</p>	<p><b>SELLERS</b></p> <p>personal access to more than 70 sales representatives in ELKO EP Holding provides impeccable services and superior products at an affordable price.</p>



If you are going to renovate the house but you do not want to interfere with existing wiring, take advantage of wireless solutions. Communication between the devices takes place wirelessly at 868-916 MHz (frequency for building automation in a given country), using the unique iNELS RF Control (RFIO) and iNELS RF Control<sup>2</sup> (RFIO<sup>2</sup>) protocols. Both are proprietary protocols of ELKO EP and are unique in their structure.

The range of units in the open air is 200 m, but in built-up area it is less (it is around 40-50 m). Everything depends on the building's design. Generally speaking, reinforced concrete causes the most interference for wireless communication; on the contrary plasterboard or glass causes the least interference. If you have problems with range, you can use a repeater (repeater). If you want to transmit the signal between floors, an efficient solution is the smart eLAN-RF-003 box.

The installation itself is variable thanks to this communication and can be gradually expanded. We recommend that you have direct line of sight between the devices that are to establish contact with each other. The ideal case is to place the central unit in the centre of the room. DIN rail or wall outlet components have clear installation rules. Components in boxed design can be placed in installation boxes, light covers or, for example, plasterboard ceilings.

Components (i.e., receivers) are divided according to the control mode, for example switching, dimming or temperature. Most components also have the ability to set the memory and retain the status when a power failure occurs. With an integrated 16A AgSnO<sub>2</sub> contact, they can also switch inductive loads.

When controlling LED light sources, a minimum brightness can be set on the dimmer to eliminate the flickering of the light source during dimming. For manufacturers, where there can be two-way source control with an existing switch and wireless technology, the RFDEL-71 and RFSAI-61B can be used to solve this problem.

The versatility of the control brings you countless choices - from the key fob, through the flat-panel controls that can be placed anywhere on the wall, to the smartphone application. About 50% of the controls are battery-powered with battery life from 3 to 5 years. The batteries ensure quiet operation and thanks to micro switches, smooth operation is also ensured. Other system units that provide more frequent communication between components or regularly perform measurements (e.g. temperature) are continuously powered from the network.

Installation recommendations and their rules can be found in the iNELS RF Control Installation Manual:  
[www.elkoep.com/inels-rf-control](http://www.elkoep.com/inels-rf-control)

**Benefits of RFIO Protocol:**

- Communication is low-energy and reliably transfers small data packets.
- No fees or licenses required.
- It does not overlap the communication space with unaddressed commands.
- Frequency used does not interfere with Wi-Fi / Bluetooth devices.
- Setting up communication between the components is not subject to work with a computer or system.

**Additional benefits of the RFIO<sup>2</sup> protocol:**

- Products labelled „RFIO<sup>2</sup>“ allow you to set selected components as repeaters.
- For components, it is easy to update FW using the RFAF / USB service device (except RFGSM-220).
- Selected features also allow communication with RFMD-100, RFWD-100 and RFS-100 / RFS-101 detectors.
- Backward compatibility with RFIO components is preserved.

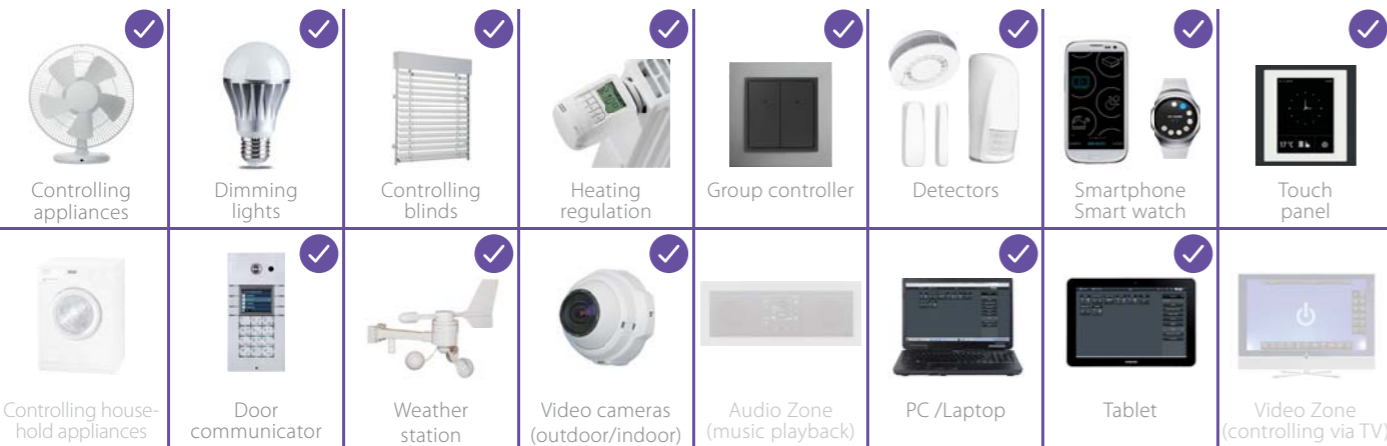

**Price of installation:**



**Energy savings:**



Series of horizontal lines for notes.

## Wireless control system

Overview of wireless system units .....	8
iNELS Wireless System .....	12
<b>Controllers</b>	
RFWB-20/G, RFWB-40/G   Wireless wall controller .....	14
RF KEY   4 button controller - keychain .....	15
RF Pilot   Wireless remote controller with display .....	16
RFIM-20B, RFIM-40B   Wireless contact converter .....	18
RFSG-1M   Wireless contact converter .....	19
<b>System units</b>	
RF Touch   Wireless touch unit .....	20
eLAN-RF-003, eLAN-RF-Wi-003   Smart RF box .....	22
Control apps .....	23
RFSGM-220M   Multifunctional GSM communicator .....	24
RFBM-2M   Energy gateway .....	26
RFRP-20   Repeater to extend the range .....	28
<b>Switches</b>	
RFSA-11B, RFSA-61B   Wireless switch unit .....	30
RFSA-62B   Wireless switch unit .....	31
RFSAI-61B   Wireless switch unit with the input .....	32
RFSAI-62B   Dual Band wireless switching component input button .....	33
RFSA-61M, RFSA-66M   Wireless switch unit .....	34
RFSC-61   Switching socket .....	35
RFUS-61   Switch unit for outdoor use .....	36
RFJA-12B, RFJA-32B   Switch unit for shutters .....	37
<b>Dimmers</b>	
RFDA-73M/RGB   Dimming actuator .....	38
RFDEL-71B   Universal dimmer .....	40
RFDEL-71M   Universal dimmer .....	41
RFDW-71   Wireless dimmer switch .....	42
RFDSC-71   Dimming socket .....	43
RFDAC-71B   Analog controller .....	44
<b>Lighting</b>	
RF-RGB-LED-550   Wireless bulb .....	45
RFSOU-1   Wireless twilight switch .....	46
<b>Temperature control</b>	
RFATV-1   Wireless thermo-valve .....	47
RFTI-10B   Wireless temperature sensor .....	48
RFSTI-11B   Switch unit with a temperature sensor .....	49
RFSTI-11/G   Switch unit with a temperature sensor .....	50
RFTC-10/G   Simple wireless temperature controller .....	51
RFTC-50/G   Wireless temperature controller .....	52
RFTC-100/G   Wireless temperature controller .....	53

## Monitoring units

RFSF-1B   Wireless flood detector .....	54
RFTM-1   Wireless pulse converter .....	55

## Detectors

RFSD-100, RFSD-101   Smoke detector .....	56
RFWD-100   Window / Door detector .....	56
RFMD-100   Motion detector .....	57

iNELS Cam   IP camera .....	57
-----------------------------	----

## Hotel Room Energy Saving Kit

RFSAI-161B   Automatic light control functionality .....	60
RFTC-150/G   Temperature control .....	62
RFSA-166M   Wireless switch unit .....	63
RFSTI-111B   Overheating protection of room .....	64
RFPCR-31/G   Multifunctional in front of Controller .....	65
RFGCR-31   Multifunctional in front of Controller .....	66
RFGCH-31   Card Switch .....	67

## Accessories

TELVA 230 V, TELVA 24 V   Termodrive .....	68
AN-I, AN-E   Antenna .....	68
FP-1   Flood probe .....	68
TC, TZ   Thermo sensors .....	69
CT50   Current transformer .....	70
LS, MS, WS   Sensors .....	70
RFAF/USB   Service Key .....	71

RF sets .....	72
Switches .....	74
Dimmers .....	75
Installation possibilities .....	76
Protocol and compatibility .....	77
Product dimension .....	78

## Controllers

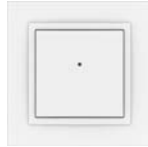

**RFWB-20/G**  
Wireless wall controller  
- 2 button



**RFWB-40/G**  
Wireless wall controller  
- 4 button



**RF Key**  
4 button controller  
- keychain



**RF Pilot**  
Wireless remote  
controller with display



**RFSG-1M**  
Wireless contact  
converter - 2 inputs

## System units



**RF Touch-B**  
Wireless touch unit  
- flush mounted



**RF Touch-W**  
Wireless touch unit  
- surface mounted



**eLAN-RF-003**  
Smart RF box



**eLAN-RF-Wi-003**  
Smart RF box with  
Wi-Fi



**RFRP-20**  
Repeater to extend  
the range

## Switches



**RFSA-11B**  
Wireless switch unit  
(single-function)  
- 1 output



**RFSA-61B**  
Wireless switch unit  
(multi-function)  
- 1 output



**RFSA-62B**  
Wireless switch unit  
(flush mounted)  
- 2 outputs



**RFSAI-61B**  
Wireless switch unit  
with the input  
(for a pushbutton)



**RFSAI-62B**  
Dual Band wireless  
switching component  
input button



**RFJA-12B**  
Switch unit for shutters



**RFJA-32B**  
Switch unit for shutters

## Dimmers



**RFDA-73M/RGB**  
Dimming actuator



**RFDEL-71B**  
Universal dimmer  
(flush mounted)



**RFDEL-71M**  
Universal dimmer  
(DIN rail mounted)

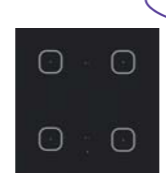

**RFDW-71**  
Wireless dimmer  
switch



**RFDSC-71**  
Dimming socket  
(multi-function)



**RFIM-20B**  
Wireless contact converter  
(2 inputs)



**RFIM-40B**  
Wireless contact converter  
(4 inputs)



**RFGSM-220M**  
Energy gateway



**RFPM-2M**  
Energy gateway



**RFSA-61M**  
Wireless switch unit  
- 1 output



**RFSA-66M**  
Wireless switch unit  
- 6 outputs



**RFSC-61**  
Switching socket  
(multi-function)



**RFUS-61**  
Switch unit for outdoor  
use (multi-function)

## Lighting



**RFSOU-1**  
Wireless twilight switch



**RF-RGB-LED-550**  
Wireless coloured bulb



**RFDAC-71B**  
Analog controller  
0(1)-10V

Temperature control



**RFATV-1**  
Wireless thermo-valve



**RFSTI-11B**  
Switch unit with a temperature sensor (flush mounted)



**RFSTI-11/G**  
Switch unit with a temperature sensor



**RFTI-10B**  
Wireless temperature sensor



**RFTC-10/G**  
Simple wireless temperature controller



**RFTC-50/G**  
Wireless temperature controllers



**RFTC-100/G**  
Wireless temperature controllers

Monitoring units



**RFSF-1B**  
Wireless flood detector



**RFTM-1**  
Wireless pulse converter



**RFSD-100, RFSD-101**  
Smoke detector wireless



**RFMD-100**  
Motion detector wireless



**RFWD-100**  
Window / Door detector wireless

Cameras



**iNELS Cam**  
IP camera



Supported video cameras

Hotel Room Energy Saving Kit



**RFSAI-161B**  
Automatic light control



**RFTC-150/G**  
Temperature control



**RFSA-166M**  
Wireless switch unit



**RFSTI-111B**  
Overheating protection of room

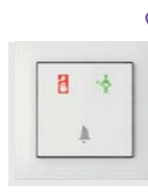

**RFPCR-31/G**  
Multifunctional in front of Controller

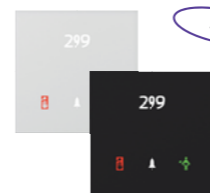

**RFGCR-31**  
Multifunctional in front of Controller



**RFGCH-31**  
Card Switch

Accessories



**FP-1**  
Flood probe



**TC TZ**  
Temperature sensors



**AN-I**  
Internal antenna



**AN-E**  
External antenna



**Telva**  
Thermdrive



**CT50**  
Current transformer



**LS, MS, WS**  
LED sensor  
Magnetic sensor



**RFAF/USB**  
Service Key

# iNELS Wireless System

RF - radiofrequency protocol  
 Wi-Fi

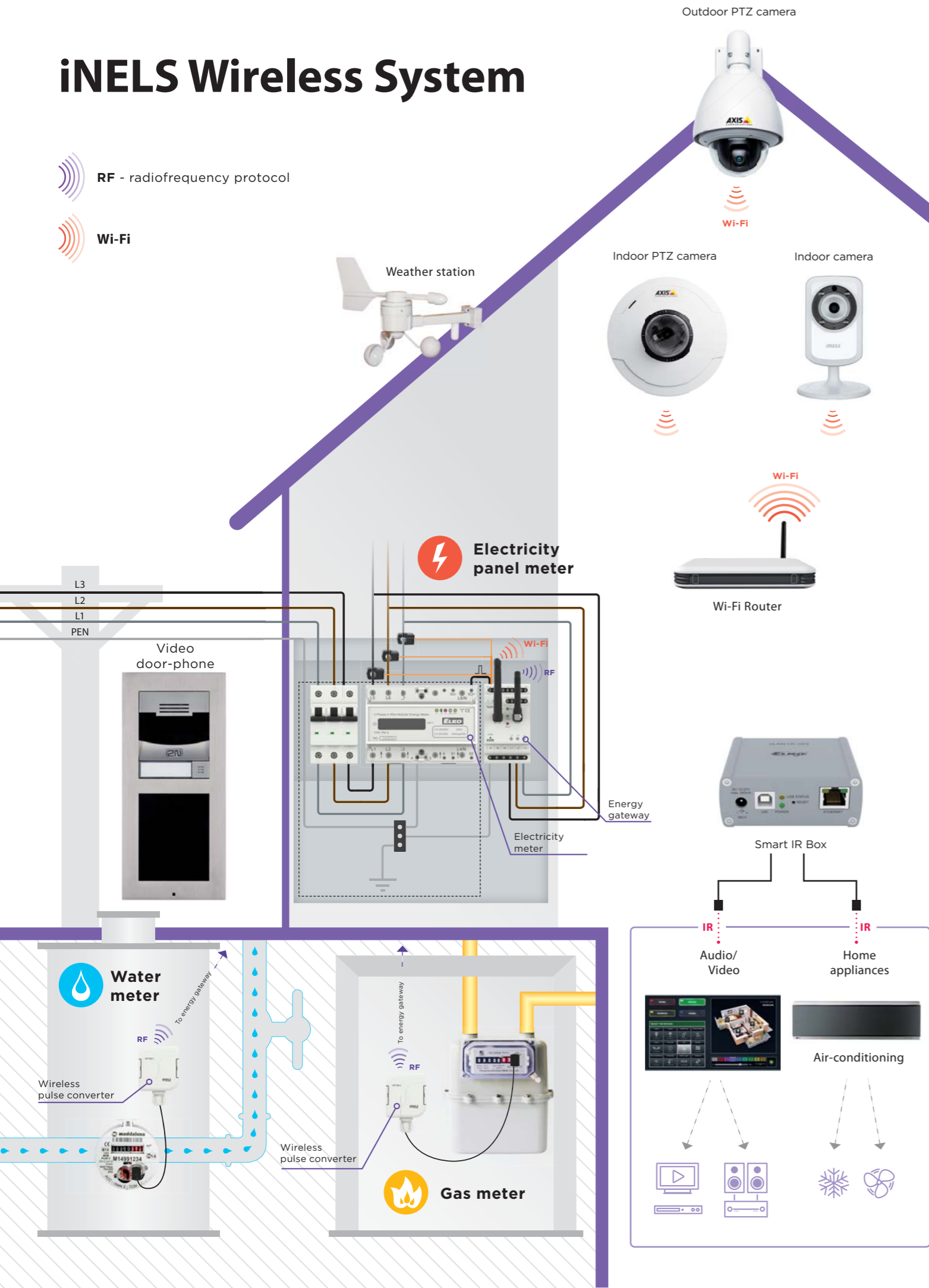

## Controllers:

Application for the smart phone

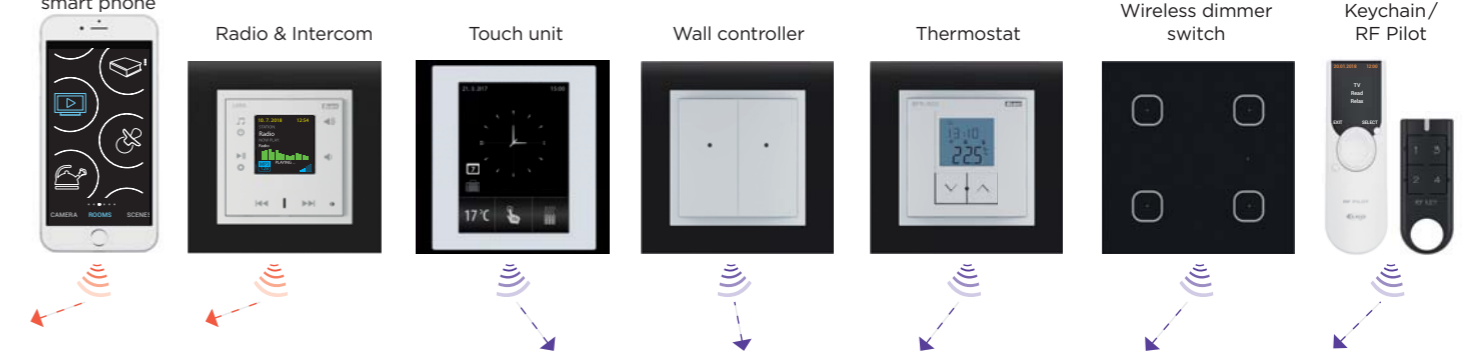

## Detectors:



## Sensors:

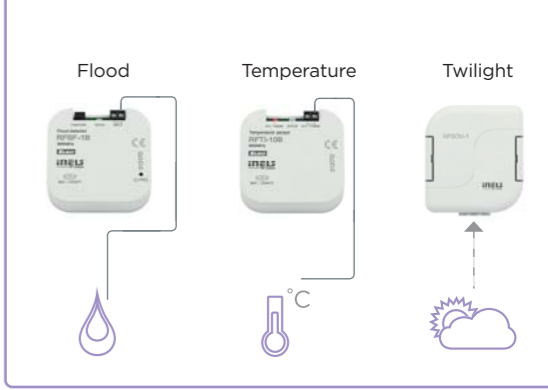

## Elements:

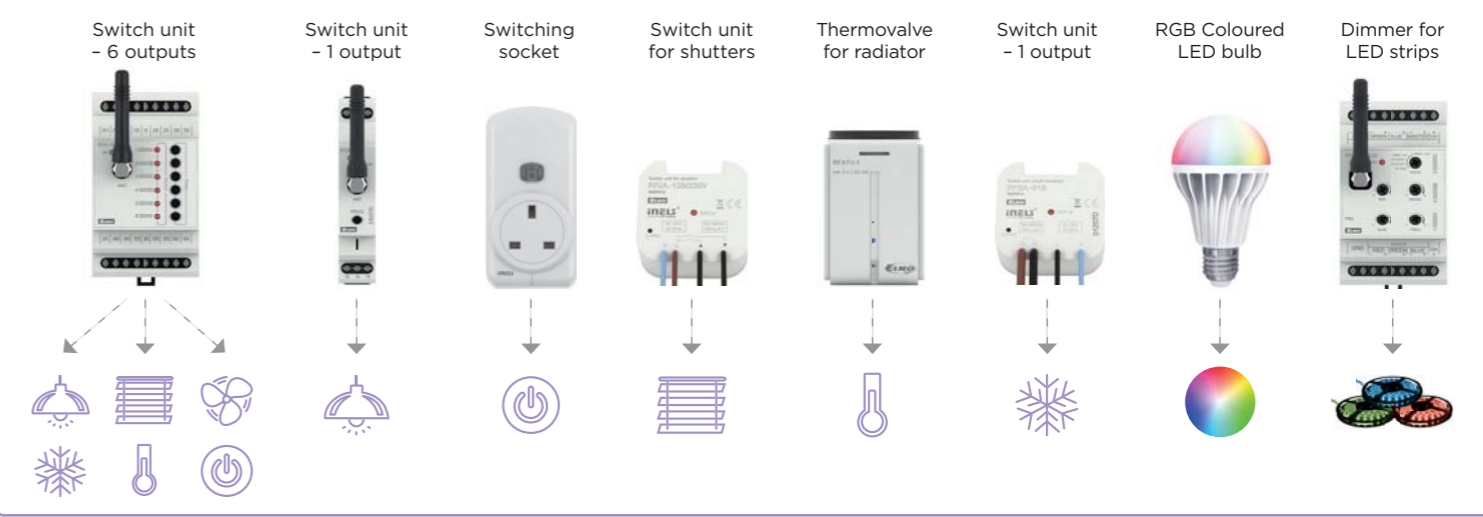

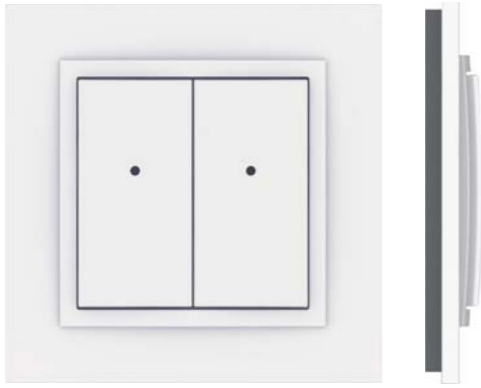

- The wireless controller is used to control switches and dimmers (lights, gate, garage door, blinds, etc.).
- **RFWB-20/G:** two buttons enable control of two units independently.
- **RFWB-40/G:** four buttons enable control of four units independently.
- The flat design with level base makes it ideal for fast installation on any surface (fixation with adhesive or screws in the installation box).
- When pressing the button, it sends a set signal (ON/OFF, dimming, time switching OFF / ON, blinds up/down).
- Sending a command is indicated by a red LED.
- In LOGUS<sup>90</sup> switch frame design (plastic, glass, wood, metal, stone).
- Option of setting light scenes, where with a single press, you can control units of iNELS RF Control.
- Battery power supply (3 V / CR2032 - included in the supply) with battery life of around 5 years based on frequency of use.
- Range up to 200 m (in open space), if the signal is insufficient between the controller and unit, use the signal repeater RFRP-20 or protocol component RFIO<sup>2</sup> that support this feature.
- Communication frequency with bidirectional protocol iNELS RF Control.

Device description

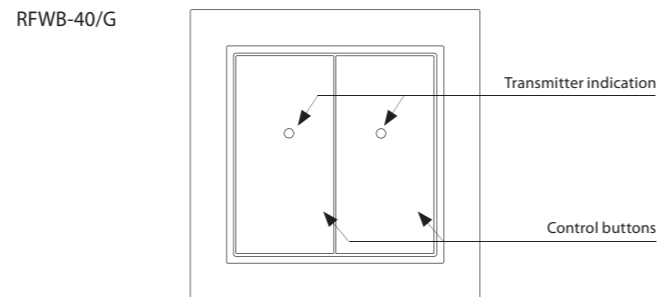
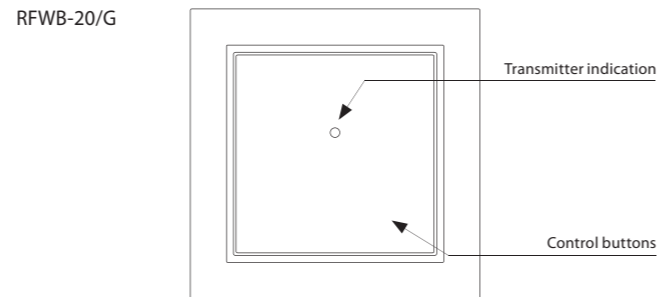

Technical parameters	RFWB-20/G	RFWB-40/G
Supply voltage:	3 V CR 2032 battery	
Transmission indication:	red LED	
Number of buttons:	2	4
Transmitter frequency:	866 MHz, 868 MHz, 916 MHz	
Signal transmission method:	unidirectionally addressed message	
Range in free space:	up to 200 m	
<b>Other data</b>		
Operating temperature:	-10 to +50 °C	
Operating position:	any	
Mounting:	glue / screws	
Protection:	IP 20	
Contamination degree:	2	
LOGUS <sup>90</sup> - Dimensions:		
Frame - plastic:	85 x 85 x 16 mm	
Frame - metal, glass, wood, granite:	94 x 94 x 16 mm	
Weight*:	38 g	39 g
Related standards:	EN 60669, EN 300 220, EN 301 489 R&TTE Directive, Order. No 426/2000 Coll. (Directive 1999/EC)	

\*Comes with plastic frame. No installation into multi-frames.

Examples of placement



LOGUS<sup>90</sup>

Choose your own style

Flat wireless switches that can be mounted on glass, tile, furniture ... Such a quick change of location when you're moving.

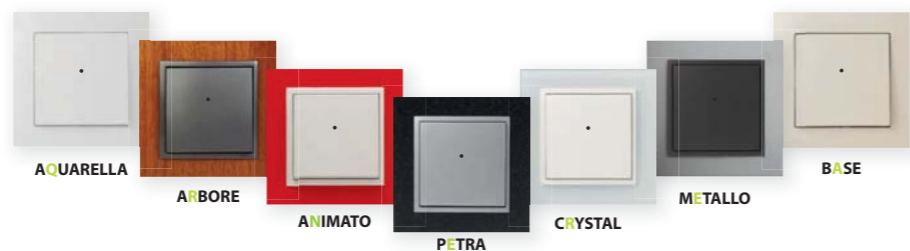

- The key alarm is used to control switches and dimmers (lights, gate, garage door, blinds, etc.).
- When pressing the button, it sends a set signal (ON/OFF, dimming, time switching OFF / ON, blinds up/down).
- Sending a command is indicated by a red LED.
- Designed in black and white with laser printing.
- Four buttons enable control of four units independently.
- Option of setting light scenes, where with a single press, you can control units of iNELS RF Control.
- Battery power supply (3 V / CR2032 - included in the supply) with battery life of around 5 years based on frequency of use.
- Range up to 200 m (in open space), if the signal is insufficient between the controller and unit, use the signal repeater RFRP-20 or protocol component RFIO<sup>2</sup> that support this feature.
- Communication frequency with bidirectional protocol iNELS RF Control.

Technical parameters	RF KEY/W	RF KEY/B
Supply voltage:	3 V CR 2032 battery	
Transmission indication:	red LED	
Number of buttons:	4	
Transmitter frequency:	866 MHz, 868 MHz, 916 MHz	
Signal transmission method:	unidirectionally addressed message	
Range in free space:	up to 200 m	
<b>Other data</b>		
Operating temperature:	-10 to +50 °C	
Operating position:	any	
Color design:	white	black
Protection:	IP 20	
Contamination degree:	2	
Dimensions:	64 x 25 x 10 mm	
Weight:	16 g	
Related standards:	EN 60669, EN 300 220, EN 301 489 R&TTE Directive, Order. No 426/2000 Coll. (Directive 1999/EC)	

Device description

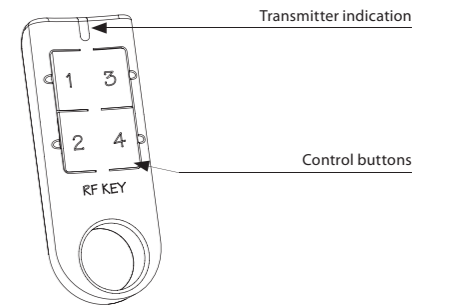





Combine the RF Pilot remote controller with the RF Touch control unit for maximum utilization of the RF Control system features.

Technical parameters	RF Pilot/W	RF Pilot/A
<b>Display</b>		
Type:	color OLED	
Resolution:	128 x 128 pixels	
Side ratio:	1:1	
Visible surface:	26 x 26 mm	
Backlighting:	self-illuminating text	
Diagonal:	1.5"	
Control:	direction button, control buttons	
<b>Power supply</b>		
Power supply:	2 x 1.5 V AAA batteries / R03	
Battery life:	approx. 3 years, according to the frequency of use and battery type	
<b>Control</b>		
Range in free space:	up to 200 m	
Frequency:	866 MHz, 868 MHz, 916 MHz	
<b>Other data</b>		
Operating temperature:	0 to +55 °C	
Storage temperature:	-20 to +70 °C	
Color design:	white	anthracite
Protection:	IP20	
Operating position:	any	
Dimensions:	130 x 41 x 18 mm	
Weight:	61 g	
Related standards:	EN 60730-1	

RF Pilot

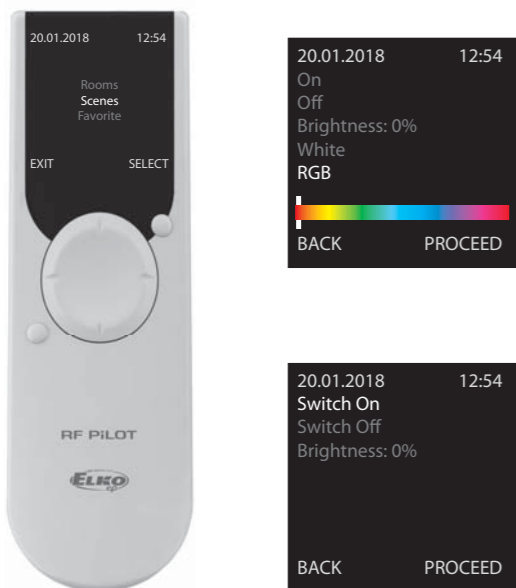

- The RF Pilot remote control is a central controller for switching electrical appliances and equipment, dimming lights, controlling blinds, etc.
- When pressing the button, it sends a set signal (ON / OFF, dimming, time switching OFF / ON, blinds up / down).
- Option of setting light scenes, where with a single press, you can control up to 10 units at once.
- The Favorites mode lets you preset the most frequently used devices on the home screen.
- Option of grouping dimmers (RFDA-73M/RGB), where you can place up to 10 units under a single control panel = control of over 100 m of colored LED strip.
- Designed in white and anthracite with color OLED display.
- Display of room temperature, battery status, date and time directly on display.
- Bidirectional communication, transmits and receives commands and displays the status of units.
- Thanks to the function of measuring the signal between the controller and unit, you can use it for testing the range and signal quality.
- It is possible to combine up to 40 units of iNELS RF Control (you can gradually expand the installation from 1 unit).
- Battery power (1.5 V 2x AAA - included in supply) with battery life of around 3 years based on frequency of use and type of batteries.
- Range up to 200 m (in open space), if the signal is insufficient between the controller and unit, use the signal repeater RFRP-20 or protocol component RFIO<sup>2</sup> that support this feature.
- Communication frequency with bidirectional protocol iNELS RF Control.

Device description

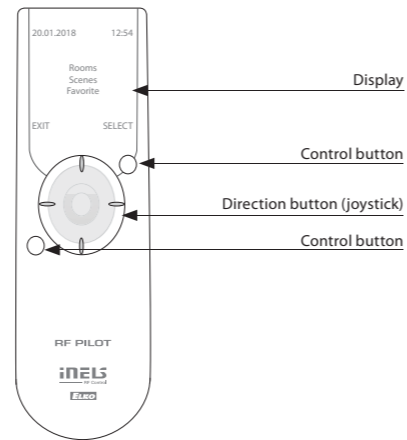

Display description

Color OLED display

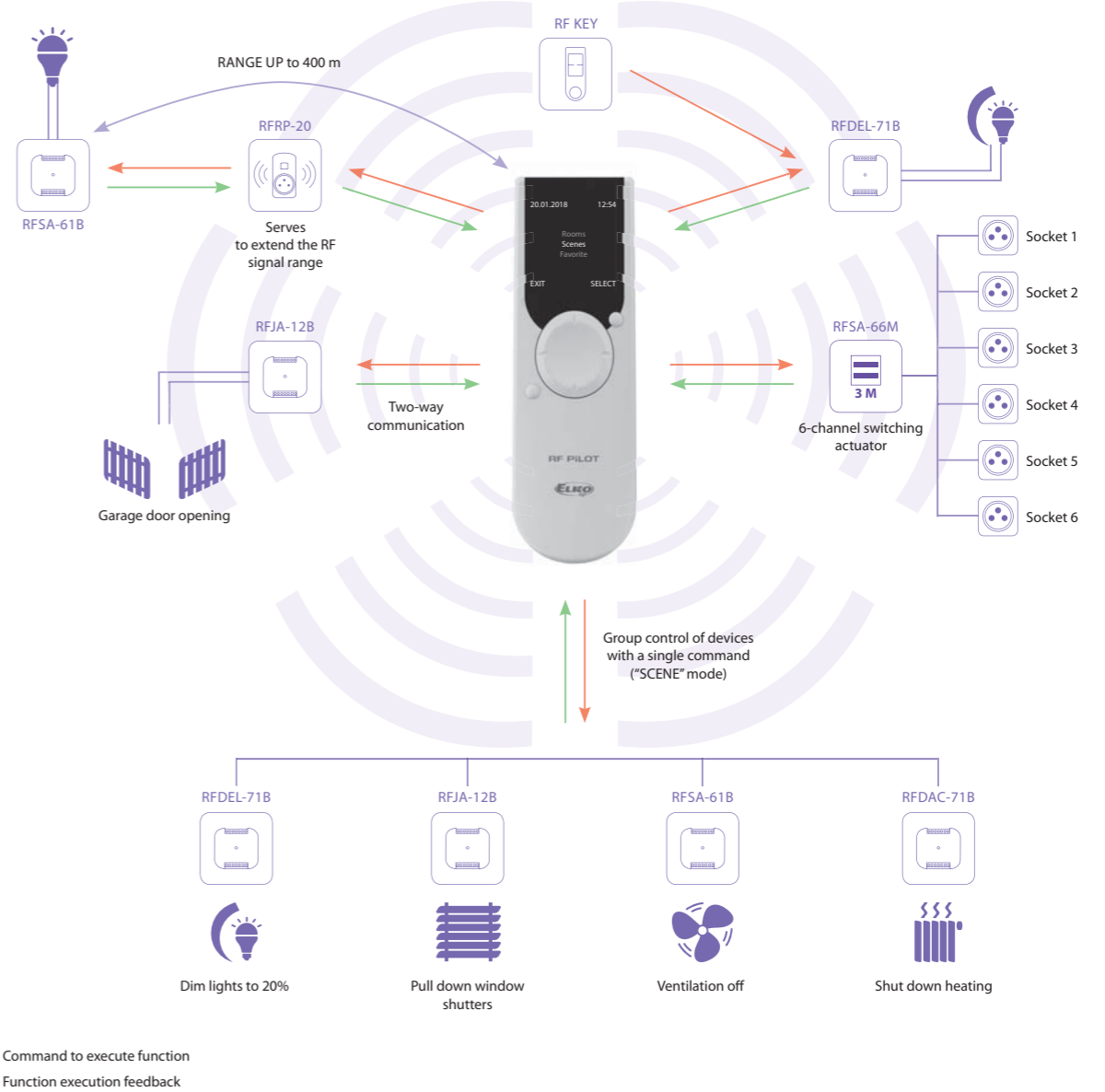
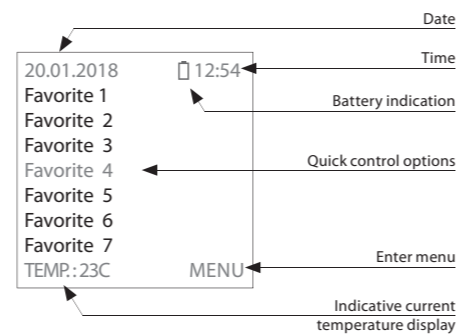

SCENES

- serves to control actuators as a group with a single touch
- possibility to set up scenes; on activation, for example, window shutters are pulled down and the light will adjust to the required brightness

WINDOW SHUTTERS

- controlling window shutters, blinds, garage door, etc.
- window shutters are controlled separately or as a group
- the window shutter receivers are powered by either 230 V or 24 V DC (shutters between windows)

FAVOURITE

- serves to select the most frequently used devices
- on display activation, the "Favourite" menu pops up automatically to provide you with a quick access to controlling devices

SWITCHING

- this function serves to switch on/off lights, sockets, electrical appliances and devices
- intuitive control thanks to customized name options
- switching actuator function selections: switch on/off, impulse relay, button, delayed ON/OFF (time of delay from 2 seconds to 60 minutes)

DIMMING

- the regulation of light intensity (light bulbs, LED strips, halogen lights with electrical or coil transformer, fluorescent tubes with dimmable ballast 1-10 V)
- customizable names of individual dimmed circuits (such as "lights" or "living room")
- "sunrise/sunset" imitation - light gradually goes on or off during the preset period between 2 seconds and 30 minutes

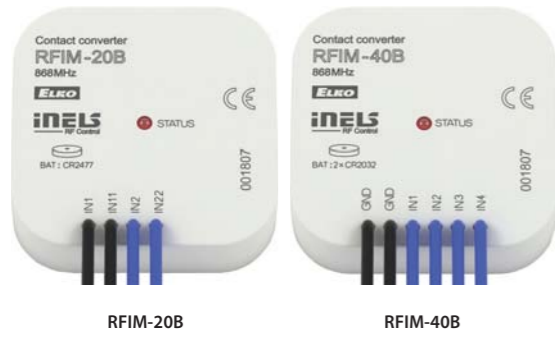

- **RFIM-20B:** the wireless contact converter changes your existing button / switch to a wireless one.
  - two inputs enable control of two units independent.
  - battery power supply (3 V / CR2477 - included in the supply) with battery life of around 5 years based on frequency of use.
  - contact can be permanently closed (does not drain on the battery).
- **RFIM-40B:** the wireless contact converter changes your existing button to a wireless one.
  - four inputs enable control of four units independently.
  - battery power supply (2x 3 V / CR2032) with battery life of around 5 years based on frequency of use (included in the supply).
  - only impulse control
- It can be used to transmit information on switching on the contact (detector, button, technology, logic output).
- The BOX design lets you mount it right in an installation box under the button or switch.
- When pressing the button, it sends a set signal (ON/OFF, dimming, time switching OFF / ON, blinds up/down).
- Sending a command is indicated by a red LED.
- Option of setting light scenes, where with a single press, you can control multiple units of iNELS RF Control.
- Range up to 200 m (in open space), if the signal is insufficient between the controller and unit, use the signal repeater RFRP-20 or protocol component RFIO<sup>2</sup> that support this feature.
- Communication frequency with bidirectional protocol iNELS RF Control.

Device description

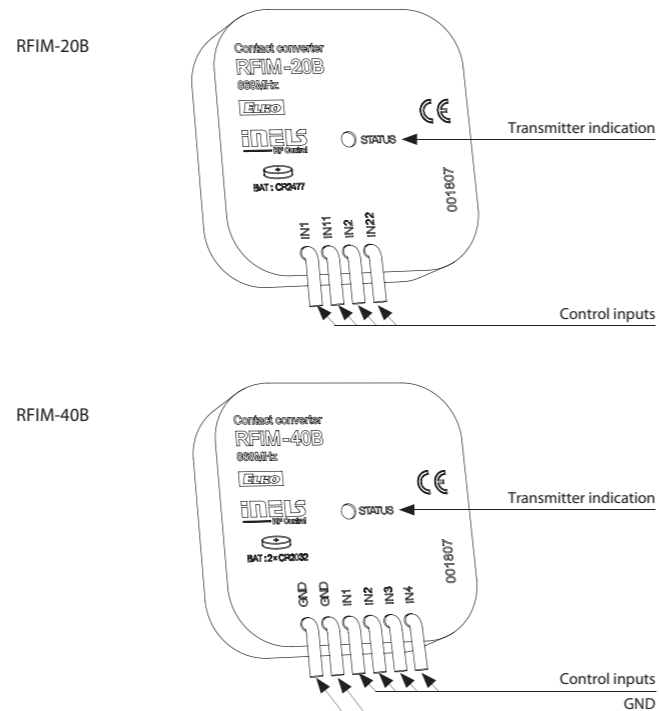

Connection

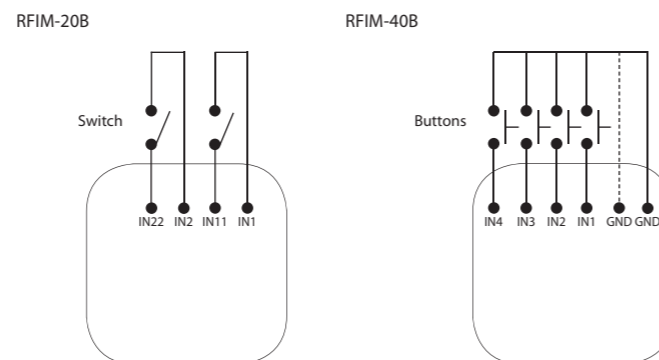

Technical parameters	RFIM-20B	RFIM-40B
Supply voltage:	1x 3 V battery CR 2477	2x 3 V battery CR 2032
Battery life:	5 years	
Transmission indication / function:	orange LED	red LED
Number of inputs:	2	4
Transmitter frequency:	866 MHz, 868 MHz, 916 MHz	
Signal transmission method:	unidirectionally addressed message	
Range in free space:	up to 200 m	
<b>Other data</b>		
Operating temperature:	-10 to +50 °C	
Operating position:	any	
Terminals (CY wire, cross-section):	4 x 0.75 mm <sup>2</sup>	6 x 0.75 mm <sup>2</sup>
Length of terminals:	90 mm	
Resist. of connection between terminals		
- for switched on button:	< 300 Ω	
- for disconnected contact:	> 10 kΩ	
Mounting:	free at lead-in wires	
Protection:	IP30	
Contamination degree:	2	
Dimensions:	49 x 49 x 13 mm	
Weight:	45 g	50 g
Open contact voltage:	pulse 12 V	3 V
Length of cable to contact:	max. 100 m of parallel lines	max. 5 m
Related standards:	EN 60669, EN 300 220, EN 301 489 R&TTE Directive, Order. No 426/2000 Coll. (Directive 1999/EC)	



Technical parameters	RFSG-1M/230V	RFSG-1M/24V
Supply voltage:	110-230 V AC / 50-60 Hz	12-24 V AC/DC / 50-60 Hz
Apparent input:	2 VA	-
Dissipated power:	0.2 W	0.5 W
Supply voltage tolerance:	+10 % / -25 %	
Power supply indication:	green LED	
<b>Input</b>		
Control voltage:	AC 12-230 V / DC 12-230 V	
Control input power:	AC 0.025 VA / DC 0.1 W	
Control terminals:	S - S	
The length of control impulse:	min. 25ms (max. unlimited)	
Transmission indication / function:	red LED	
Transmitter frequency:	866 MHz, 868 MHz, 916 MHz	
Signal transmission method:	unidirectionally addressed message	
Range in free space:	up to 160 m	
Minimum control distance:	20 mm	
Output for antenna:	SMA connector*	
<b>Other data</b>		
Operating temperature:	-15 to +50 °C	
Operating position:	any	
Mounting:	DIN rail support EN 60715	
Protection:	IP20 from the front panel	
Overvoltage category:	III.	
Contamination degree:	2	
Connecting conductor cross-section: (mm <sup>2</sup> ):	max. 1x 2.5, max. 2x 1.5 / with a hollow max. 1x 2.5	
Dimensions:	90 x 17.6 x 64 mm	
Weight:	62 g	
Related standards:	EN 60669, EN 300 220, EN 301 489 R&TTE Directive, Order. No 426/2000 Coll. (Directive 1999/EC)	

\* Max Tightening Torque for antenna connector is 0.56 Nm.

- This wireless contact converter is especially appropriate for wireless transmission of information on switching HDO.
- Thanks to the network supply, it can also be used for partial transmission of information for control of an appliance or device.
- One-module design of the unit with mounting into switchboard.
- After leading in power to the "S" terminals, it periodically transmits the command switch on in an interval of 10 min. When disconnecting the power supply, immediately switch off.
- The button TEST on the controller is used to assign to a switching unit.
- Option of setting light scenes, where with a single press, you can control multiple units of iNELS RF Control.
- The package includes an internal antenna AN-I, in case of locating the converter in a metal switchboard, you can use the external antenna AN-E for better signal reception.
- Range up to 160 m (in open space), if the signal is insufficient between the controller and unit, use the signal repeater RFRP-20 or protocol component RFIO<sup>2</sup> that support this feature.
- Communication frequency with bidirectional protocol iNELS RF Control.

Device description

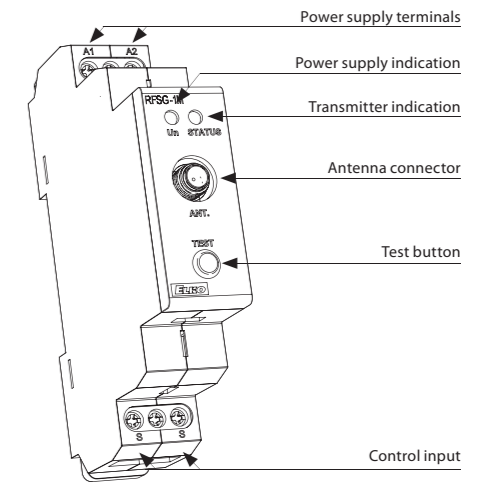

Connection





RF Touch-B

RF Touch-W

- The wireless touch unit RF Touch is a central controller for heating, switching electrical appliances and equipment, dimming lights, controlling blinds, etc.
- It transmits and receives commands from units and processes set programs for automatic control.
- Thanks to bi-directional communication, it visualizes the current status of individual units.
- Automatic control based on weekly program.
- Touch 3.5" color display.
- It is possible to combine up to 40 units of iNELS RF Control + 30 Oasis detectors (you can gradually expand the installation from 1 unit).
- Power to the touch unit is in the range 100-230 V AC, (RF Touch/W also supplied via adapter 12 V DC (included in the supply).
- RF Touch/W: wall mounting, secured in an installation box or glued to glass, wood, dry wall, etc.
- RF Touch/B: mounting of unit in installation box.
- Range up to 100 m (in open space), if the signal is insufficient between the RF Touch and unit, use the signal repeater RFRP-20 or protocol component RFIO<sup>2</sup> that support this feature.
- Communication frequency with bidirectional protocol iNELS RF Control.
- Color design of RF Touch:
  - frames: in basic plastic design (white, black, red) or in the luxury design LOGUS<sup>90</sup> - glass, metal (aluminum, nickel, titanium).
  - intermediate frames: in basic white and dark gray with metallic coat - aluminum, pearl, ice and gray.
  - rear cover: in white, ivory, light gray and dark gray
- You can choose your own color combination at e-shop ELKO EP.

In 2011, the RF Touch wireless unit won the prize GOLDEN AMP.

- Colour combination of your choice, you can choose at the ELKO EP e-shop.



black / white

chrome / grey

Technical parameters		RF Touch-B	RF Touch-W
<b>Display</b>			
Type:	color TFT LCD		
Resolution:	320 x 240 pixels / 262,144 colors		
Side proportion:	3:4		
Visible surface:	52.5 x 70 mm		
Backlighting:	active (white LED)		
Touch area:	resistive 4-conductor		
Diagonal:	3.5"		
Control:	touch		
<b>Power supply</b>			
Supply voltage/rated current:	100 - 230 V AC	from the back 100 - 230 V AC, from the side 12 V DC*	
Input power:	max. 5W		
Power supply terminals:	A1 - A2		
<b>Control</b>			
Range:	100 m		
Min. distance RF Touch - Actuator:	1m		
Frequency:	866 MHz, 868 MHz, 916 MHz		
<b>Connection</b>			
Connection:	terminal box	no-screw push-in terminal box or jack Ø 2.1 mm jack connector	
Cross-section of connecting wires:	max. 2.5 mm <sup>2</sup> /1.5 mm <sup>2</sup> with a hollow		
<b>Operating conditions</b>			
Operating temperature:	0 to +50°C		
Storage temperature:	- 20 to +70°C		
Protection:	IP 20		
Overvoltage category:	III.		
Contamination degree:	2		
Operating position:	any		
Installation:	an installation box	anywhere indoor	
Dimensions:	94 x 94 x 36 mm	94 x 94 x 24 mm	
Weight:**	127 g	175 g	
Related standards:	EN 60730-1		

\* Adapter is included in the RF Touch-W unit package.

\*\* Weight includes the plastic frame and the intermediate frame.



white / pearly

glass / grey

red / aluminum

aluminum / dark grey

titanium / ice

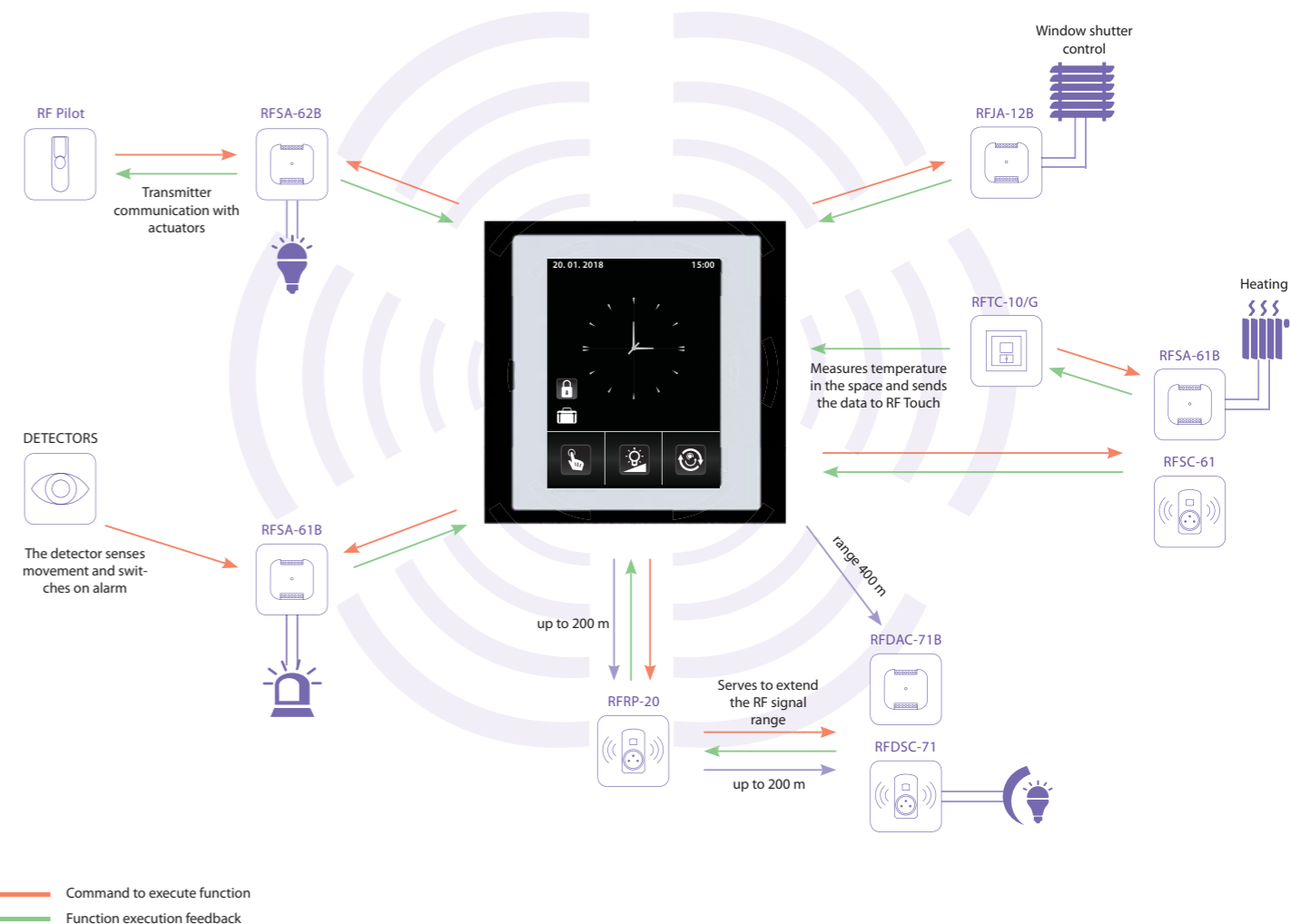

## HEATING

- control of heating devices (boilers, thermo valve 0-10 V...)
- temperature regulation in the entire house or in individual rooms
- information about outdoor temperature (wireless temperature sensor)
  - terraces
- possibility to set your own heating program for the whole week
- holiday mode will interrupt the heating program when you are on holiday
- room temperature correction (during the heating program) is performed with a digital thermal regulator command

## DIMMING

- the regulation of light intensity (light bulbs, LED bulbs, LED strips, halogen lights with electrical or coil transformer, fluorescent tubes with dimmable control gear 1-10 V)
- customizable names of individual dimmed circuits (such as "living room lights")
- "sunrise/sunset" imitation - light gradually goes on or off during the preset period between 2 seconds and 30 minutes

## DETECTORS

- RF Touch communicates with detectors - window, door, movement...
- possible to combine with switching actuators
- clear control over the entire house

## SWITCHING

- this function serves to switch on/off lights, sockets, electrical appliances and devices
- intuitive control thanks to customized name options
- switch clock enabling you to switch appliances in real time, even during your absence (simulation of the presence of persons, etc.)
- switching actuator function selections: switch on/off, impulse relay, button, delayed ON/OFF (time of delay from 2 seconds to 60 minutes)

## WINDOW SHUTTERS

- controlling window shutters, sunblinds, blinds, garage door, etc.
- window shutters are controlled separately or as a group
- setting an independent time schedule for pulling up/down
- the window shutter receivers are powered by either 230 V or 24 V DC (shutters between windows, etc.)

## QUICK CONTROL

- serves to control group of actuators with a single touch
- possibility to set up scenes; on activation, for example, window shutters are pulled down and lights are adjusted to required intensity



eLAN-RF-003

eLAN-RF-Wi-003

Technical parameters	eLAN-RF-003	eLAN-RF-Wi-003
<b>Interface RF Control</b>		
Communication protocol:	RF Touch Compatible	
Broadcasting frequency:	866 MHz, 868 MHz, 916 MHz	
Signal transfer method:	two-way addressed message	
Output for antenna:	SMA connector*	
Antenna RF:	1 dB (part of supply)	
Indications RF communications:	1 x red RF status LED	1 x green RF status LED
Range in free space:	up to 100 m	
<b>Interface Ethernet</b>		
ETH operating status indicator:	green LED	
ETH communication indicator:	yellow LED	
Communications interface:	100 Mbps (RJ45)	
Preset IP address:	192.168.1.1	
<b>Interface Wi-Fi</b>		
Standard:	x	IEEE 802.11 b/g/n / 2.4 GHz
Wi-Fi Security:	x	WEP, WPA-PSK, WPA2-PSK
Frequency range Wi-Fi:	x	R-SMA
Antenna Wi-Fi:	x	1 dB (part of supply)
Indications Wi-Fi communication:	x	1 x red Wi-Fi status LED
Range:	x	in to 200 m
Supply voltage/current:	10-27 V DC / 200 mA SELV	10-27 V DC / 300 mA SELV
Power:	adapter with connector Jack Ø 2.1 mm (part of supply) or connector USB-B	
Supply voltage indication:	green LED POWER	
Button RESET:	settings to their defaults	
Power source:	230 VAC / 12 V DC part of supply of device	
<b>Operating conditions</b>		
Operating temperature:	-20 to +50 °C	
Storage temperature:	-25 to +70 °C	
Protection:	IP20	
Contamination degree:	2	
Working position:	any	
Dimensions:	90 x 52 x 65 mm	
Weight:	136 g	145 g

\* Max Tightening Torque for antenna connector is 0.56 Nm.

- The smart RF box enables you to control your electrical installation by smartphone, tablet or SMART TV.
- It transmits and receives commands of up to 40 units, and it processes set programs for automatic control, (you can gradually expand installation from 1 unit iNELS RF Control).
- Thanks to bi-directional communication, it visualizes the current status of individual units.
- The smart RF box eLAN-RF-003 is connected by network cable LAN to the home network (router) and communicates with your smart phone.
- The RF eLAN-RF-Wi-003 RF smart box creates its own Wi-Fi network. Once a smartphone is connected to this network, you can communicate with other devices.
- The intuitive application environment offers central control from one place.
- Function of application iHC-MAIRF / iHC-MIIRF:
  - control of hot water or electric underfloor heating
  - measuring temperature by wireless sensors
  - switching appliances (garage door, blinds, fan, sprinklers, sockets, etc.)
  - dimming lights (LED, energy-saving, halogen or classic lamps)
  - time switching (delayed switching off of light when leaving room)
  - video camera integration
  - light scenes (make multiple commands at once with a single press).
- If you don't have a fixed IP address, the Smart RF box will obtain it from DHCP server automatically.
- Power is supplied to the Smart RF box via adapter 10-27 V DC (included in the supply) or PoE by power source (router) 24 V DC.
- To amplify the signal, two eLAN-RF units can be connected via a LAN cable. These units cannot be operated independently.
- Option of setting via web interface or directly in the application iHC-MAIRF (Android) / iHC-MIIRF (iPhone).
- The package includes an internal antenna AN-I, in case the Smart RF box is located in a metal switchboard, you can use the external antenna AN-E for better signal reception.
- Range up to 100 m (in open space), if the signal is insufficient between the Smart RF box and unit, use the signal repeater RFRP-20 or protocol component RFIO<sup>2</sup> that support this feature.
- Communication frequency with bidirectional protocol iNELS RF Control.

#### Device description

eLAN-RF-Wi-003

#### Front panel

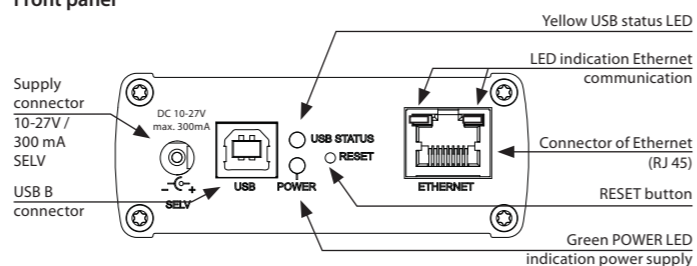

#### Back panel

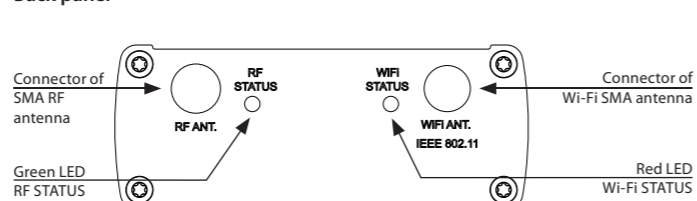

#### Smartphones



iHC-MAIRF

iHC-MIIRF

- Control application for smart phones with Android operating system - iHC-MAIRF and for smart phones iPhone - iHC-MIIRF
- The application iHC-MAIRF / iHC-MIIRF allows you to control your home easily by smartphone.
- The user-friendly and intuitive application environment offers central control from one place.
- iHC-MAIRF / iHC-MIIRF enables control of RF units by smart phone via a smart RF box, which is connected to the home Internet network.
- The smart RF box controls up to 40 units of iNELS RF Control, (you can gradually expand control from 1 unit of iNELS RF Control).
- If you don't have a permanently set IP address, the application supports its automatic obtaining from the DHCP server.
- Functions of the application iHC-MAIRF / iHC-MIIRF:
  - regulation of hot water or electric underfloor heating (setting a weekly program)
  - measuring temperature (e.g. by wireless sensors)
  - switching appliances (garage door, blinds, fans, sprinklers, sockets, etc.)
  - dimming lights (LED, energy-saving, halogen lamps or classic light bulbs)
  - time switching (delayed switching off of light when leaving room)
  - integration of video cameras
  - light scenes (one press to perform multiple commands simultaneously)
  - remote control (switch on heating before returning from vacation).
- The application iHC-MAIRF supports Android versions from 2.3 in your smartphone.

#### Smart TV



- RF Smart box (eLAN-RF ...) allows remote devices to control a SMART TV.
- Operation with conventional control of TV.
- Compatible with every Smart TV, which has an integrated web browser.
- In the Web browser you enter the IP address of the smart RF box.
- Feedback on the switching component is indicated by green colour in the icon.
- Functionality:
  - Switching ON / OFF, automatic timing,
  - Dimming ON / OFF, smooth start / stop, change colour,
  - Scenes
  - Form of heating temperature indication (to make changes directly in the smart phone application)
  - Camera (possibility to stream live images if it is supported by a Web browser on the SMART TV).
- Form control is free and is not licensed.

#### Smart watch Samsung GEAR S2 / S3



TIZEN iHC-WTRF

- Applications to control appliances via smart watches Samsung Gear S2 / S3.
- Smart watches are associated with the controlled appliances through RF smart box eLAN-RF.
- Functionality:
  - Switching appliances, sockets,
  - Automatic timing,
  - Dimming the lights, adjust the colour,
  - Control garage doors, gates, gates and shutters,
  - Features scenes for group commands.
- Intuitive and easy to control in many combinations, touching the display and moving wheels on Samsung Gear S2 / S3.
- The setting is done by applying iNELS Home Control iHC-MAIRF directly or via a web interface RF smart box eLAN-RF.
- It is not necessary to carry a smart phone to control, the watch functions independently.



- The multi-function GSM communicator is used for remote switching of heating, lights, gate, garage door, etc.
- GSM communicator can be used in several ways, which can be combined:
  - control by telephone, where a sent SMS or ringing through once switches an internal relay.
  - reacts to 1 of 4 potential free wired inputs (detectors, switches), where it is possible to set a consequent reaction.
  - offers the option of ascertaining the status of units iNELS RF Control (ON/OFF, temperature).
  - control by telephone, where a sent SMS or ringing through once transmits an RF command to the switching unit within range, which then switches something (e.g. heating).
  - security function (switching on the ALARM) in combination with wireless detectors, where activation / deactivation takes place by ringing through once or by key alarm.
- The three-module design of the unit into a switchboard enables connection of a switched load 2x 8 A (2x 2000 W).
- Settings are performed by SW Connect 1 via mini USB connector
- Li-Ion battery for 30 minute function backup
- The GSM communicator is powered by an adapter in the range 11-30V DC.
- The package includes an internal antenna AN-I, in case of locating the communicator in a metal switchboard, you can use the external antenna AN-E for better signal reception.
- Range up to 150 m (in open space), if the signal is insufficient between the controller and unit, use the signal repeater RFRP-20 or protocol component RFIO<sup>2</sup> that support this feature.
- Communication frequency with bidirectional protocol iNELS RF Control<sup>2</sup> (RFIO<sup>2</sup>).
- Package includes: 2x internal antenna AN-I, mini USB connector, SW Connect 1, adapter 12 V 6 W.

#### Device description

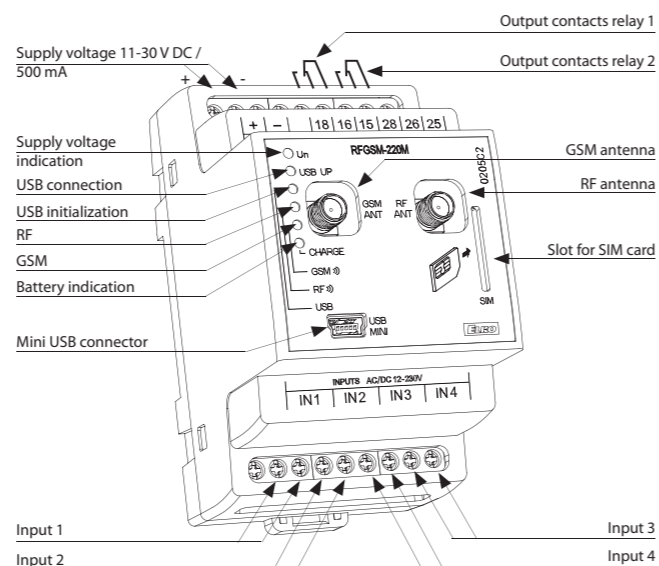

Technical parameters		RFGSM-220M
<b>Power</b>		
Supply voltage:	11-30 V DC;	backup power supply Li-Ion batteries
Maximum power consumption:	1 W in standby mode /	power supply and communication max. 18 W
Current consumption:	90 mA at 12 V DC	
Consumption during communication:	max. 1.5 A at 12 V DC	
Working band of GSM module:	850/900/1800/1900 MHz	
Transmitter output power:	2 W for GSM 900, 1 W for GSM 1800	
<b>Inputs IN1, IN2, IN3, IN4</b>		
Control voltage:	AC 12-230 V or DC 12-230 V	(separated optocoupler)
Control input power:	AC 0.025 VA/ DC 0.1 W	
Length of control impulse:	min. 50 ms/ max. unlimited	
Inputs RF:	one-/two-way addressed message	866 MHz, 868 MHz, 916 MHz
<b>Outputs</b>		
Number of contacts:	2x Switches (AgSnO <sub>2</sub> )	
Rated current:	8 A / AC1	
Switching power:	2500 VA, 240 W	
Min. switching power DC:	500 mW	
Mechanical service life (AC1):	1x10 <sup>7</sup>	
Electrical service life:	1x10 <sup>5</sup>	
RF outputs:	two-way addressed message	866 MHz, 868 MHz, 916 MHz
<b>Other data</b>		
Operating system PC:	MS Windows XP and higher	
Range of RF module:	up to 150 m	
Output for antenna:	SMA connector*	
Operating temperature:	- 15 up to + 50°C	
Operating position:	any	
Mounting:	DIN rail EN 60715	
Protection:	IP 20 from front panel	
Overvoltage category:	II.	
Contamination degree:	2	
Cross-section of connecting wires (mm <sup>2</sup> ):	max. 1x 2.5; max. 2x 1.5 /	with a hollow max. 1x 2.5
Dimensions:	90 x 52 x 65 mm	
Weight:	198 g	
Related standards:	EN 60730-1	

\* Max Tightening Torque for antenna connector is 0.56 Nm.

#### Connection

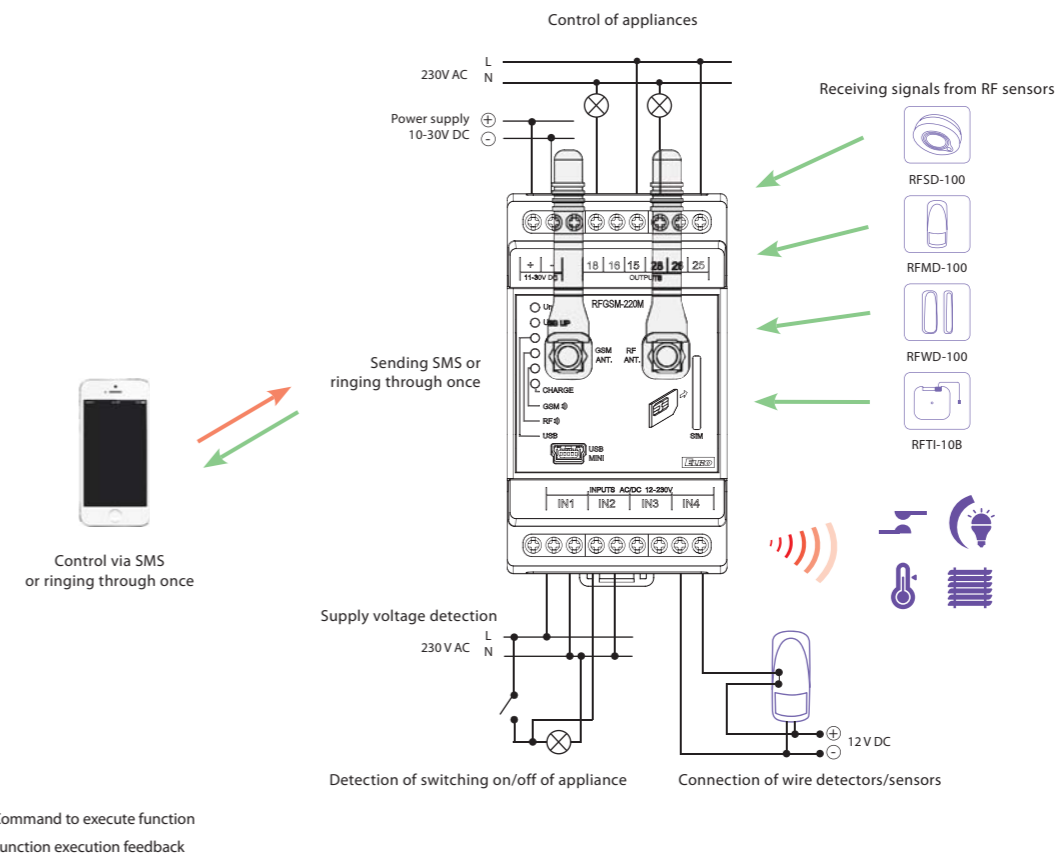

**A)** Thanks to the GSM communicator, you immediately know what the temperature is at home right now. Just send an SMS or ring the communicator once, the RF signal transfers this command to RF Touch and from RF Touch an SMS text message reply is sent back to your phone with the current temperature. You can then switch the heating on or off.

**B)** By sending an SMS or ringing once, you activate the GSM communicator, which sends an RF command to the temperature actuator, which then switches the heating (cable connection applied between the actuator and heater).

**C)** GSM communicator enables you to directly switch on up to 4 appliances. Its usefulness thus expands from simply switching into the area of detectors. One of 4 inputs receives information from the detector and sends it by SMS to the given telephone number.



- The energy gateway is a central device for assessing energy consumption (electricity, water, gas).
- It acts as an interface between the pulse converter RFTM-1 and your smartphone. The Energy Gateway allows you to connect up to 8 pulse transducers.
- Connection to the data network is made by means of LAN Ethernet connector or wirelessly via a Wi-Fi network.
- Monitored data is stored on internal memory storage.
- By means of the application iHC and cloud connection, it is possible to maintain online access to data and monitoring history.
- Up to 4 tariff meter readings of electricity consumption, which can be displayed in the form of kWh or financial costs.
- Option of setting reaction to specific consumption to switch the output on or off (RFS-A-6x and CU3).
- The unit enables connecting up to three current transformers CT50 to each other for measuring electricity.
- Direct connection to iNELS BUS using integrated CIB terminals.
- 3-module design, mounted on a DIN rail into the switchboard.
- The supply includes an internal antenna AN-I, if the unit is installed in a metal switchboard, you can use the external antenna AN-E to enhance the signal.
- The device supply voltage is provided from monitored phases.
- Range up to 100 m (in open space), if the signal between the controller and the user is weak, use the signal repeater RFRP-20 or protocol component RFIO<sup>2</sup> that support this feature.
- Communication frequency with bidirectional protocol iNELS RF Control.

## Connection

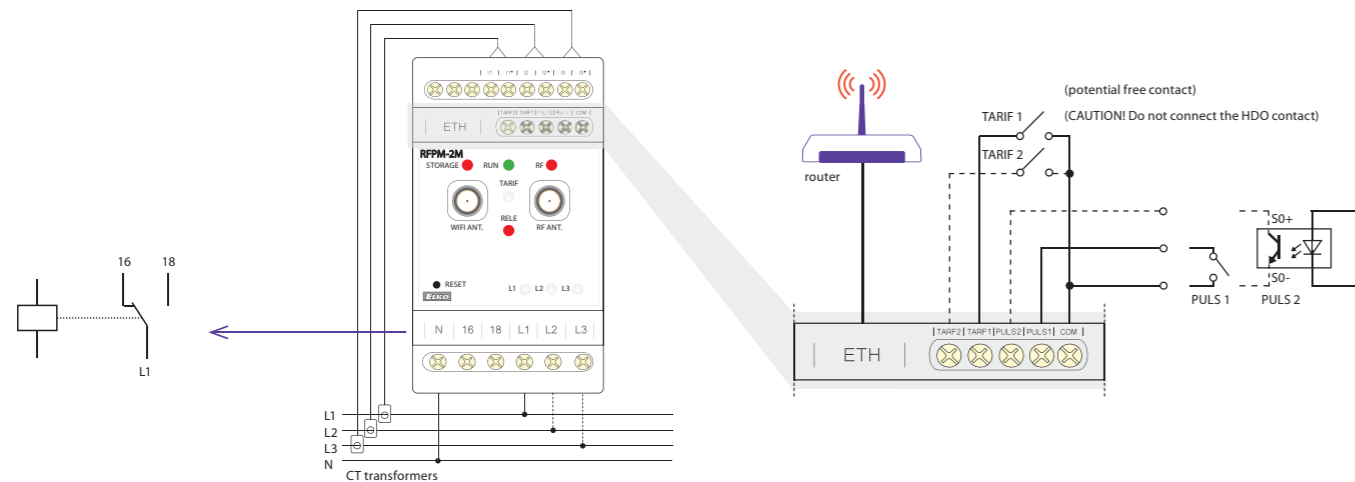

## Device description

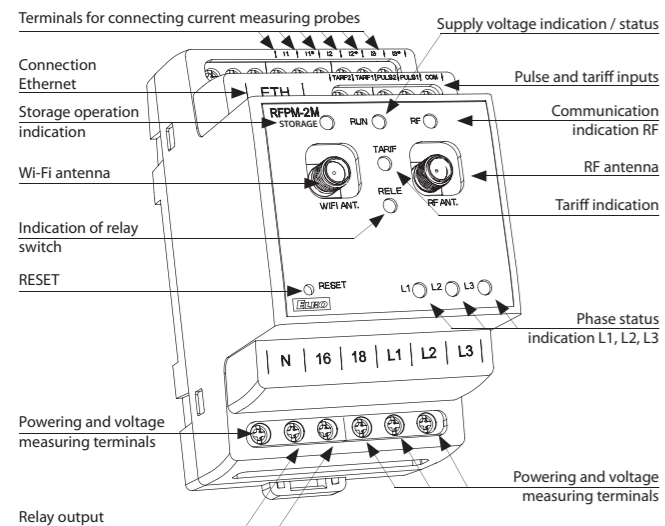

Tariff indication - RGB LED	
TARIF 1:	red
TARIF 2:	green
TARIF 3:	blue
TARIF 4:	yellow

Phase status indicator L1, L2, L3 - R/G LED	
failure (outage):	red
active phase:	green
unmonitored phase:	LED off

## Current transformer CT50

The package includes the current transformer CT50. For more information see p. 70.

Technical parameters	RFPM-2M
Supply / measured voltage:	230 V AC / 50-60 Hz, 1f / 3f +N
Supply voltage tolerance:	+15/-20%
Closed relay power input:	5 VA
Switching voltage level:	140 V, +10/-20%
<b>Output RELE</b>	
Number of contacts:	1 NO/ NC switches L1
Max. current:	16 A / AC1
Switching power:	4000 VA (AC1)
Mechanical service life:	3 x 10 <sup>7</sup>
Electrical service life:	0.7 x 10 <sup>5</sup>
Relay reaction:	programmable settings, see instruction manual
<b>Interface RF Control</b>	
Communication protocol:	RF Touch Compatible
Broadcasting frequency	866 MHz, 868 MHz, 916 MHz
Signal transfer method:	two-way addressed message
Output for antenna:	SMA - FEMALE*
Antenna RF:	1 dB (part of supply)
Range in open space:	up to 100 m
<b>Controlling</b>	
Controlling:	WEB / Mobile Applications
Button Reset:	Bluetooth (press >2 s) / Unit reset (press >10 s)
<b>Interface Wi-Fi</b>	
Wi-Fi mode:	AP Bridge / AP LAN / Client
Standard:	IEEE 802.11 b/g/n / 2.4 GHz
Wi-Fi Security:	WEP, WPA-PSK, WPA2-PSK
Frequency range Wi-Fi:	RP - SMA - FEMALE*
Antenna Wi-Fi:	1 dB (part of supply)
Range:	up to 20 m
<b>Interface Ethernet</b>	
Connection:	static IP / DHCP Client
Transfer speed:	10 / 100 Mbit / s
Connector:	RJ45
Preset IP address / IP address of bootloader:	192.168.1.2
<b>Measuring</b>	
Pulse inputs:	PULS1 (S0), PULS2 (S0)
Tariff inputs:	TARIF1, TARIF2 - binary combination
Option of switching inputs:	switching by contact / opening by collector
Separation by isolation of power and control circuits:	reinforced insulation (Cat. II surges by EN 60664-1)
Probes measuring current:	3x CT-50
Wireless consumption sensor:	RFTM-1
<b>Measuring circuit</b>	
Network:	1f-3f
Frequency:	50 - 60 Hz / ±10 %
Accuracy:	Class 1.0
Current measuring coil:	max. 50 A (current transformer CT50)
Wire diameter:	max. 16 mm
<b>Other data</b>	
Working temperature:	-20 .. + 35°C
Storage temperature:	-30 .. +70°C
Operating position:	vertical
Mounting:	DIN rail EN60715
Protection:	IP20 from front panel / IP40 in cover
Overvoltage category:	II.
Degree of pollution:	2
Cross-section of connecting wires (mm <sup>2</sup> ):	max. 1x 2.5, max. 2x 1.5 / with a hollow max. 1.5
Dimension:	90 x 52 x 65 mm
Weight:	125 g

\* Max Tightening Torque for antenna connector is 0.56 Nm.

## Methods of sensing meters

### CT (Current transformer)

Opening pliers open/close on the existing wire of the measured circuit, most frequently at the main supply at the electricity meter.

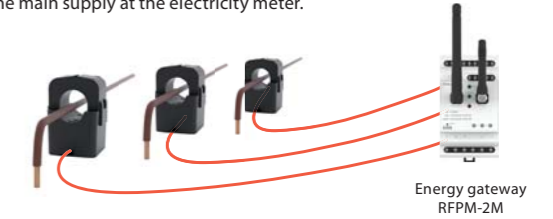

### LS (LED sensor)

The LED sensor scans LED impulses on the meter, which indicates consumption by flashing.

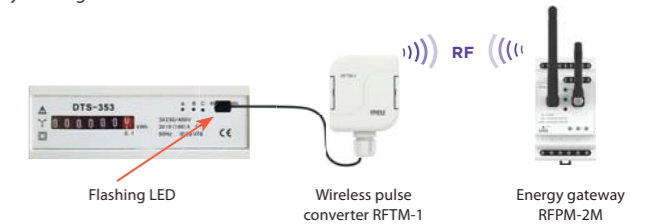

### MS (Magnetic sensor)

The magnetic sensor scans movement of the numeral, upon which a permanent magnet is placed.

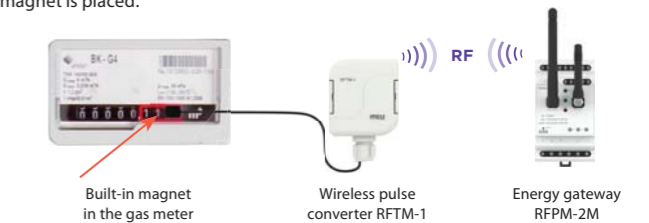

### WS (Magnetic sensor for water meter)

The magnetic sensor detects the pulse that is created with each rotation of the magnet placed on the unit dial (supported producer Maddalena - type TCM 142/08-4627).

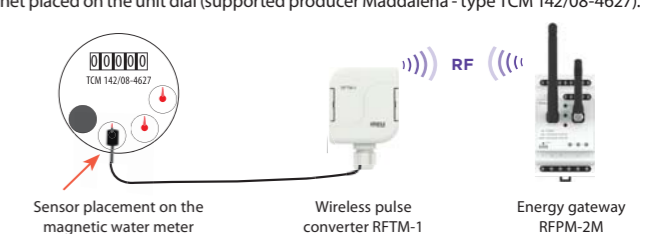

### IMP (Output „S0“)

Meters with impulse output indicated as „S0“ connected by wires to terminals GND and DATA1 on the sensor RFTM-1.

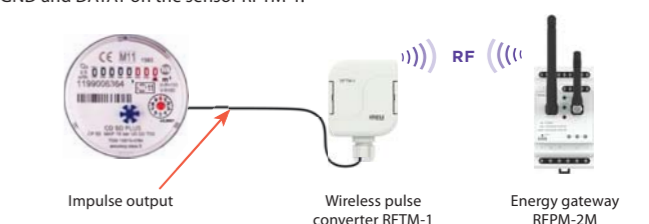



- Radio frequency signal repeater
- This signal repeater is used to extend the range between the controller and unit by up to 200 meters.
- It is designed to transmit a signal up to 20 units.
- Thanks to the socket design, installation is simple by direct insertion into the existing socket, the throughsocket function remains unchanged.
- Indication:
  - green LED - supply voltage
  - red LED - active status (receiving and transmitting an RF signal)
- Programming is performed by a button.
- Communication frequency with bidirectional protocol iNELS RF Control.

- Produced in 5 designs of sockets and plugs:

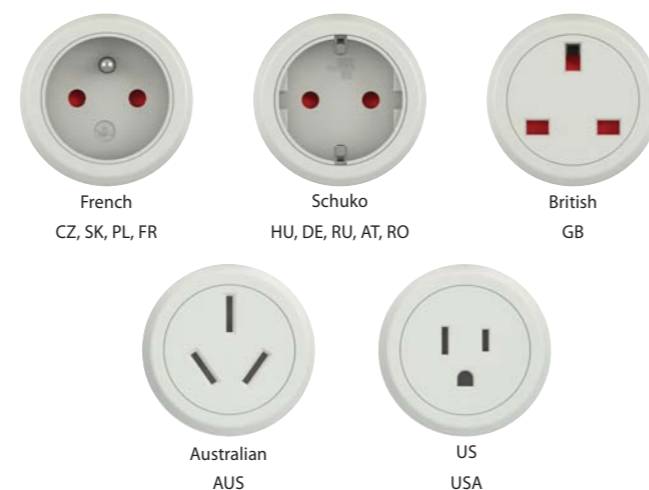

Technical parameters	RFRP-20/230V	RFRP-20/120V
Supply voltage:	230 - 250 V / 50-60 Hz	120 V AC / 60 Hz
Apparent input:	6 VA	
Dissipated power:	0.7 W	
Transmitter frequency:	866 MHz, 868 MHz, 916 MHz	
Range in free space:	up to 200 m	
Minimum control distance:	20 mm	
Programming:	button - green LED / red LED	
<b>Other data</b>		
Operating temperature:	-20 to +55 °C	
Storage temperature:	-30 to +70°C	
Mounting:	plug into a socket	
Protection:	IP20 Device	
Dimensions:	60 x 120 x 80 mm	
Weight:	225 g	
Related standards:	EN 607 30-1 ED.2	

#### Controlling up to 20 actuators

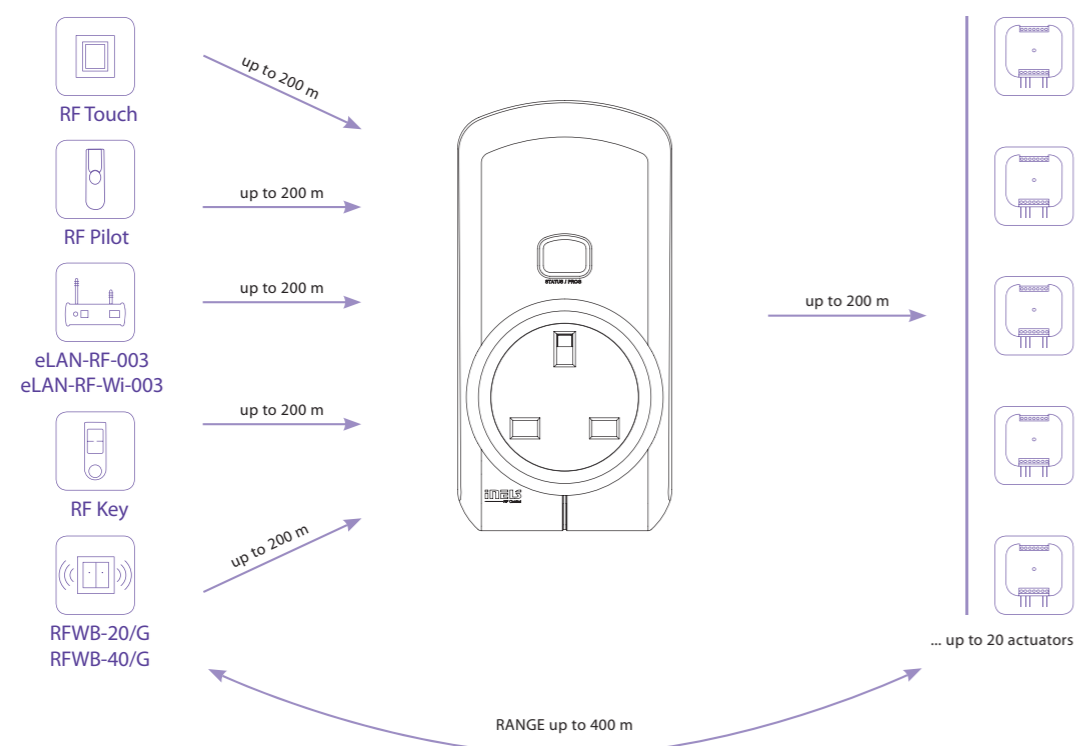



- The switching unit with 1 output channel is used to control appliances, lights (easy to integrate it to control garage doors or gates).
- They can be combined with detectors, controllers, iNELS RF Control or system components.
- The BOX design lets you mount it right in an installation box, a ceiling or controlled appliance cover.
- It enables connection of the switched load up to 16 A (4 000 W).
- **RFSA-11B:** single-function design - switch on / off.
- **RFSA-61B:** multi-function design – button, impulse relay and time function of delayed ON or OFF with time setting of 2 s-60 min.
- The switching unit may be controlled by up to 25 channels (1 channel represents 1 button on the controller).
- The programming button on the unit is also used for manual control of the output.
- Memory status can be pre-set in the event of a power failure.
- For components it is possible to set the repeater function via the RFAF / USB service device.
- Range up to 200 m (in open space), if the signal is insufficient between the controller and unit, use the signal repeater RFRP-20 or protocol component RFIO<sup>2</sup> that support this feature.
- Communication frequency with bidirectional protocol iNELS RF Control<sup>2</sup> (RFIO<sup>2</sup>).

#### Device description

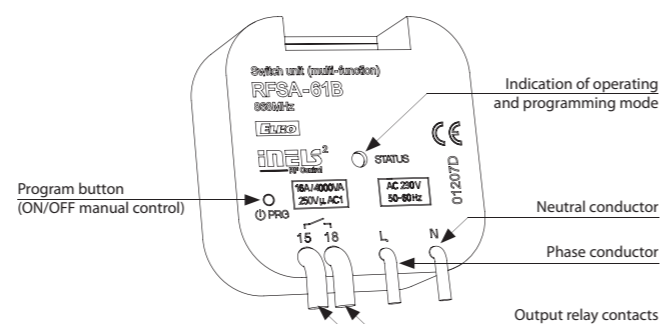

#### Function

For more information see p. 74.

#### Connection

RFSA-11B/230V, RFSA-61B/230V  
RFSA-11B/120V, RFSA-61B/120V

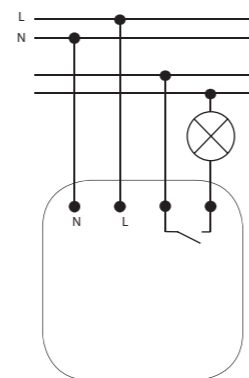
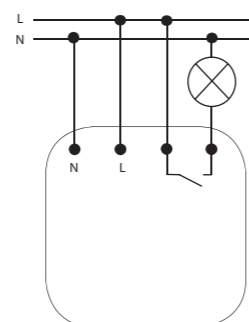

RFSA-61B/24V

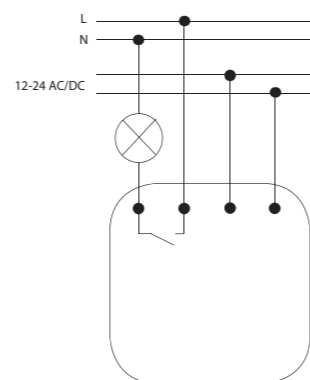

Technical parameters	RFSA-62B/320V	RFSA-62B/120V	RFSA-62B/24V
Supply voltage:	230 V AC / 50-60 Hz	120 V AC / 60 Hz	12-24 V AC / DC
Apparent input:	7 VA / cos φ = 0.1	7 VA / cos φ = 0.1	-
Dissipated power:	0.7 W	0.7 W	0.7 W
Supply voltage tolerance:	+10 %; -15 %		
<b>Output</b>			
Number of contacts:	2 x switching (AgSnO <sub>2</sub> )		
Rated current:	8 A / AC1		
Switching power:	2000 VA / AC1		
Peak current:	10 A / <3 s		
Switching voltage:	250 V AC1		
Max. DC switching power:	500 mW		
Mechanical service life:	1x10 <sup>7</sup>		
Electrical service life (AC1):	1x10 <sup>5</sup>		
<b>Control</b>			
RF, by command from transmitter:	866 MHz, 868 MHz, 916 MHz		
Manual control:	PROG (ON/OFF) button		
Range in free space:	up to 100 m		
<b>Other data</b>			
Operating temperature:	-15 to + 50 °C		
Operating position:	any		
Mounting:	free at lead-in wires		
Protection:	IP 30		
Overvoltage category:	III.		
Contamination degree:	2		
Terminals (CY wire, cross-section):	1x 2.5 mm <sup>2</sup> , 3x 0.75 mm <sup>2</sup>	1x2.5, 4x0.75mm <sup>2</sup>	
Length of terminals:	90 mm		
Dimensions:	49 x 49 x 21 mm		
Weight:	46 g		
Related standards:	EN 60669, EN 300 220, EN 301 489 R&TTE Directive, Order. No 426/2000 Coll. (Directive 1999/EC)		

- The switching unit with 2 output channels is used for controlling appliances and light circuits.
- They can be combined with detectors, controllers, iNELS RF Control or system components.
- The BOX design lets you mount it right in an installation box, a ceiling or controlled appliance cover.
- It enables connection of switched load 2x 8 A (2x 2 000 W).
- Function: button, impulse relay and time function of delayed start and return with time setting range of 2 s-60 min.
- It is possible to assign any function to each output relay.
- Each of the channels may be controlled by up to 12/12 channels (1 channel represents 1 button on the controller).
- The programming button on the unit is also used for manual control of the output.
- Memory status can be pre-set in the event of a power failure.
- For components it is possible to set the repeater function via the RFAF / USB service device.
- Range up to 100 m (in open space), if the signal is insufficient between the controller and unit, use the signal repeater RFRP-20 or protocol component RFIO<sup>2</sup> that support this feature.
- Communication frequency with bidirectional protocol iNELS RF Control<sup>2</sup> (RFIO<sup>2</sup>).

#### Device description

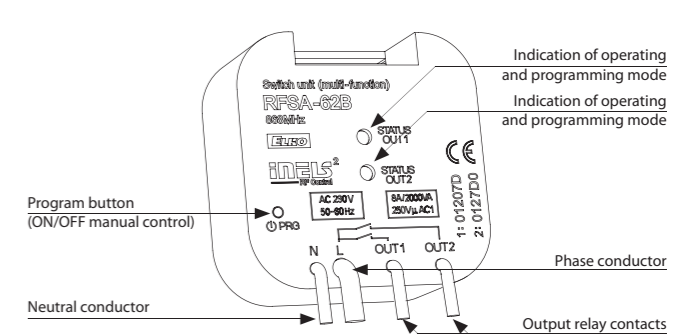

#### Function

For more information see p. 74.

#### Connection

RFSA-62B/230V  
RFSA-62B/120V

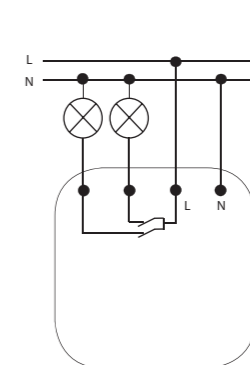

RFSA-62B/24V

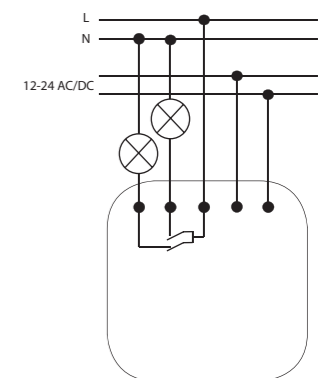





- The switching unit with 1 output channel is used for controlling appliances and lights. It is possible to connect the existing button to the internal terminal in the wiring.
- They can be combined with detectors, controllers, iNELS RF Control or system components.
- The BOX design lets you mount it right in an installation box, a ceiling or controlled appliance cover.
- It enables connection of the switched load up to 16 A (4 000 W).
- Function: button, impulse relay and time function of delayed start or return with time setting range of 2 s-60min.
- External button is programmed as a wireless button.
- Input is not galvanic isolated.
- The switching unit may be controlled by up to 25 channels (1 channel represents 1 button on the controller).
- The programming button on the unit is also used for manual control of the output.
- Memory status can be pre-set in the event of a power failure.
- For components it is possible to set the repeater function via the RFAF / USB service device.
- Range up to 200 m (in open space), if the signal is insufficient between the controller and unit, use the signal repeater RFRP-20 or protocol component RFIO<sup>2</sup> that support this feature.
- Communication frequency with bidirectional protocol iNELS RF Control<sup>2</sup> (RFIO<sup>2</sup>).

#### Device description

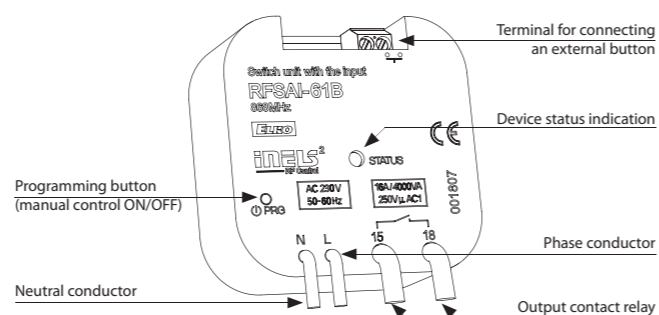

#### Function

For more information see p. 74.

#### Connection

RFSAI-61B/230V  
RFSAI-61B/120V

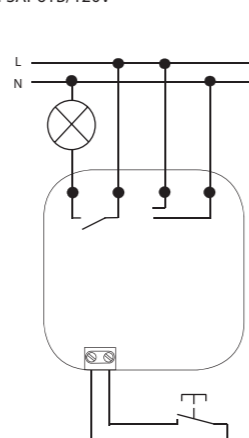

RFSAI-61B/24V

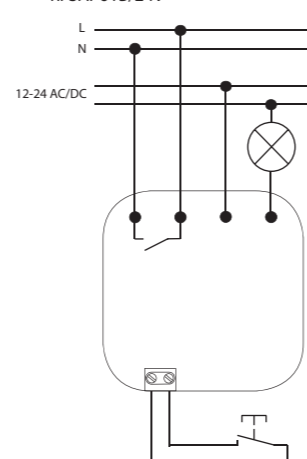

Technical parameters	RFSAI-61B/230V	RFSAI-61B/120V	RFSAI-61B/24V
Supply voltage:	230 V AC / 50-60 Hz	120 V AC / 60 Hz	12-24 V AC / DC 50-60 Hz
Apparent power:	7 VA / cos φ = 0.1	7 VA / cos φ = 0.1	-
Dissipated power:	0.7 W	0.7 W	0.7 W
Supply voltage tolerance:	+10 %; -15 %		
<b>Output</b>			
Number of contacts:	1x switching (AgSnO <sub>2</sub> )		
Rated current:	16 A / AC1		
Switching power:	4000 VA / AC1, 384 W / DC		
Peak current:	30 A / <3 s		
Switching voltage:	250 V AC1 / 24 V DC		
Min. switching power DC:	500 mW		
Mechanical service life:	3x10 <sup>7</sup>		
Electrical service life (AC1):	0.7x10 <sup>5</sup>		
<b>Controlling</b>			
RF command from the transmitter:	866 MHz, 868 MHz, 916 MHz		
Manual control:	button PROG (ON/OFF)		
External button:	max. 12 m cable *		
Range in open space:	up to 200 m		
<b>Other data</b>			
Voltage of open contact:	3 V		
Resist. of connection for closed contact:	<1 kΩ		
Resist. of connection for open contact:	>10 kΩ		
Galvanic isolation of input:	no $\Delta$		
Operating temperature:	15 up to + 50 °C		
Working position:	any		
Mounting:	free at lead-in wires		
Protection:	IP30		
Overvoltage category:	III.		
Contamination degree:	2		
Terminals (CY wire, Cross-section):	2x 0.75 mm <sup>2</sup> , 2x 2.5 mm <sup>2</sup>		
Terminal length:	90 mm		
Dimensions:	49 x 49 x 21 mm		
Weight:	46 g		
Related standards:	EN 60669, EN 300 220, EN 301 489 R&TTE Directive, Order. No 426/2000 Coll. (Directive 1999/EC)		

\* Control button input is at the supply voltage potential.



Technical parameters	RFSAI-62B/230V	RFSAI-62B/120V	RFSAI-62B/24V
Supply voltage:	230 V AC / 50-60 Hz	120 V AC / 60 Hz	12-24 V AC/DC 50-60 Hz
Apparent power:	7 VA / cos φ = 0.1	7 VA / cos φ = 0.1	-
Dissipated power:	0.7 W	0.7 W	0.7 W
Supply voltage tolerance:	+10 %; -15 %		
<b>Output</b>			
Number of contacts:	2x switching (AgSnO <sub>2</sub> )		
Rated current:	8 A / AC1		
Switching power:	2000 VA / AC1, 192 W / DC		
Peak current:	10 A / <3 s		
Switching voltage:	250 V AC1 / 24 V DC		
Min. switching power DC:	500 mW		
Mechanical service life:	1x10 <sup>7</sup>		
Electrical service life (AC1):	1x10 <sup>5</sup>		
<b>Controlling</b>			
RF command from the transmitter:	866 MHz, 868 MHz, 916 MHz		
Manual control:	button PROG (ON/OFF)		
External button:	max. 12 m cable *		
Range in open space:	up to 200 m		
<b>Other data</b>			
Voltage of open contact:	2.5 V		
Resist. of connection for closed contact:	<1 kΩ		
Resist. of connection for open contact:	>10 kΩ		
Galvanic isolation of input:	no $\Delta$		
Operating temperature:	-15 .. + 50 °C		
Working position:	any		
Mounting:	free at lead-in wires		
Protection:	IP30		
Overvoltage category:	III.		
Contamination degree:	2		
Terminals (CY wire, Cross-section):	3x 0.75 mm <sup>2</sup> , 1x 2.5 mm <sup>2</sup>   4x 0.75, 1x 2.5 mm <sup>2</sup>		
Terminal length:	90 mm		
Dimensions:	49 x 49 x 21 mm		
Weight:	46 g		
Related standards:	EN 60669, EN 300220, EN 301489 R&TTE Directive, Order. No 426/2000 Coll. (Directive 1999/EC)		

\* Control button input is at the supply voltage potential.

- Switching component with 2 relay outputs are used to control appliances and lights. Internal terminals can connect two existing buttons in the wiring.
- They can be combined with detectors, controllers, iNELS RF Control or system components.
- The BOX design lets you mount it right in an installation box, a ceiling or controlled appliance cover.
- It enables connection of the switched load up to 2x 8 A (2x 2 000 W).
- Function: button, impulse relay and time function of delayed start or return with time setting range of 2s-60min. It is possible to assign any function to each output relay.
- External button is programmed as a wireless button.
- Input is not galvanic isolated!
- Each output can be controlled by up to 12/12 channels (1 channel represents 1 button on the controller).
- The programming button on the unit is also used for manual control of the output.
- Memory status can be pre-set in the event of a power failure.
- For components labelled as iNELS RF Control<sup>2</sup> (RFIO<sup>2</sup>), it is possible to set the repeater function via the RFAF/USB service device.
- Range up to 200 m (in open space), if the signal is insufficient between the controller and unit, use the signal repeater RFRP-20 or protocol component RFIO<sup>2</sup> that support this feature.
- Communication frequency with bidirectional protocol iNELS RF Control (RFIO<sup>2</sup>).

#### Device description

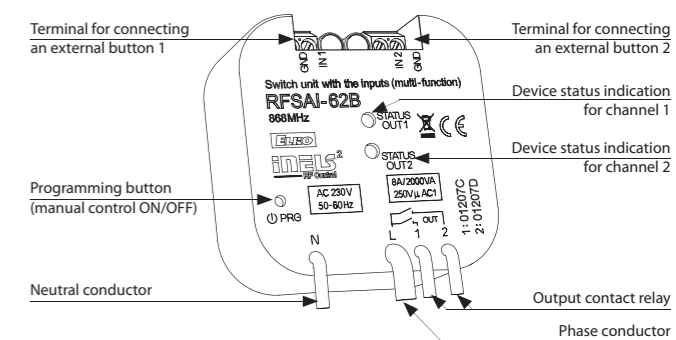

#### Function

For more information see p. 74.

#### Connection

RFSAI-62B/230V  
RFSAI-62B/120V

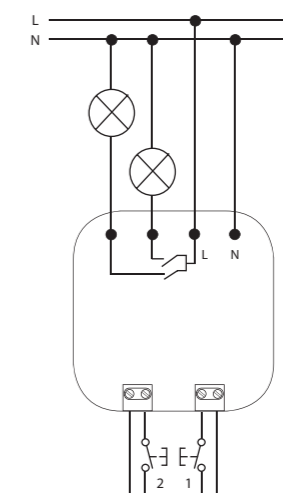

RFSAI-62B/24V

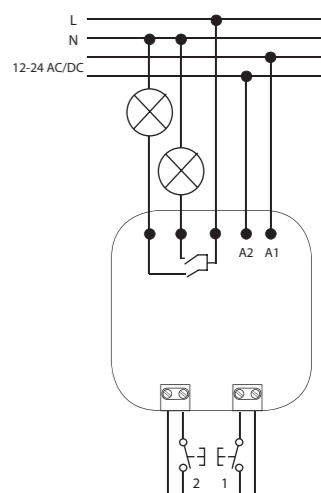



Technical parameters	RFSA-61M/230V	RFSA-61M/24V	RFSA-66M/230V	RFSA-66M/24V
Supply voltage:	110-230VAC / 50-60 Hz	12-24 V AC/DC SELV	10-230 V AC / 50-60 Hz	12-24 V AC/DC SELV
Apparent input:	2.7 VA / cos φ = 0.6	-	min. 2 VA / max. 5 VA	-
Dissipated power:	1.62 W	0.8 W	min. 0.5 W / max. 2.5 W	max. 1.8 W
Supply voltage tolerance:	+10% / -25 %			
<b>Output</b>				
Number of contacts:	1x changeover (AgSnO <sub>2</sub> )	3x changeover (AgSnO <sub>2</sub> ); 3x switching (AgSnO <sub>2</sub> )		
Rated current:	16 A / AC1	8 A / AC1		
Switching power:	4000 VA / AC1, 384 W / DC	2000 VA / AC1		
Peak current:	30 A / <3 s	10 A / <3 s		
Switching voltage:	250 V AC1 / 24 V DC	250 V AC1		
Max. DC switching power:	500 mW	500 mW		
Mechanical service life:	3x10 <sup>7</sup>	1x10 <sup>7</sup>		
Electrical service life (AC1):	0.7x10 <sup>5</sup>	1x10 <sup>5</sup>		
<b>Control</b>				
RF, by command from transmitter:	866 MHz, 868 MHz, 916 MHz			
Manual control:	PROG (ON/OFF) button			
Range in free space:	up to 200 m			
Output for antenna:	SMA connector*			
<b>Other data</b>				
Operating temperature:	-15 °C to + 50 °C			
Operating position:	any			
Mounting:	DIN rail EN 60715			
Protection:	IP20 from the front panel			
Overvoltage category:	III.			
Contamination degree:	2			
Connecting conductor cross-section (mm <sup>2</sup> ):	max. 1x 2.5, max. 2x 1.5 / with a hollow max. 1x 2.5			
Dimensions:	90 x 17.6 x 64 mm	90 x 52 x 65 mm		
Weight:	74 g	264 g		
Related standards:	EN 60669, EN 300 220, EN 301 489 R&TTE Directive, Order. No 426/2000 Coll. (Directive 1999/EC)			

\* Max Tightening Torque for antenna connector is 0.56 Nm.

- **RFSA-61M:** the switching unit with 1 output channel is used for controlling appliances, sockets or lights.
  - the one-module design of the unit into a switchboard enables connection of a switched load up to 16 A (4 000 W).
  - the switching unit may be controlled by up to 25 channels (1 channel represents 1 button on the controller).
- **RFSA-66M:** the switching unit with 6 output channels is used for independent control of up to 6 appliances, sockets or lights. It is possible to assign any function to each output relay.
  - the three-module design of the unit into a switchboard enables connection of a switched load 6x 8 A (6x 2000 W).
  - it is just right for creating scenes, where with one push of the controller, you can switch on or off all 6 channels simultaneously.
  - each of the channels may be controlled by up to 25 channels (1 channel represents one button on the controller).
- They can be combined with detectors, controllers, iNELS RF Control or system components.
- The integrated switching contact enables connection, where the controlled appliance may be switched on or off by command.
- Function: button, impulse relay and time function of delayed start or return with time setting range of 2 s-60 min.
- The programming button on the unit is also used for manual control of the output.
- The package includes an internal antenna AN-I, in case of locating the element in a metal switchboard, you can use the external antenna AN-E for better signal reception.
- Memory status can be pre-set in the event of a power failure.
- For components it is possible to set the repeater function via the RFAF / USB service device.
- Range up to 200 m (in open space), if the signal is insufficient between the controller and unit, use the signal repeater RFRP-20 or protocol component RFIO<sup>2</sup> that support this feature.
- Communication frequency with bidirectional protocol iNELS RF Control<sup>2</sup> (RFIO<sup>2</sup>).

**Device description**

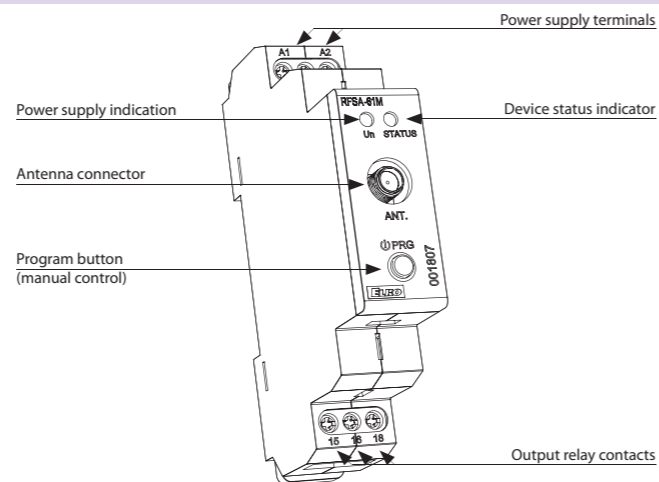

**Function**

For more information see p. 74.

**Connection**

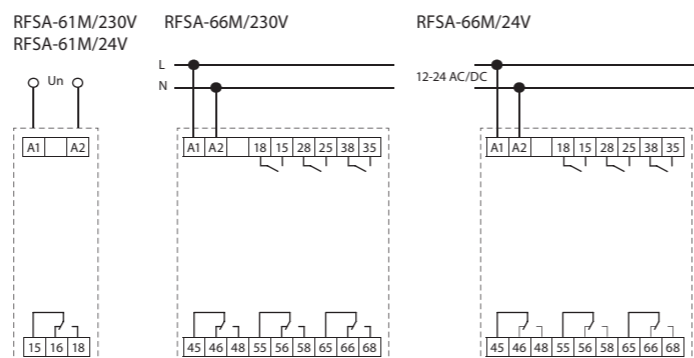

Technical parameters	RFSC-61/230V	RFSC-61/120V
Supply voltage:	230 - 250 V / 50-60 Hz	120 V AC / 60 Hz
Apparent power:	6 VA	
Dissipated power:	0.7 W	
Supply voltage tolerance:	+10 %; -15 %	
<b>Output</b>		
Number of contacts:	1x switching (AgSnO <sub>2</sub> )	
Rated current:	16 A / AC1	
Switching power:	4000 VA / AC1, 384 W / DC	
Peak current:	30 A / <3 s	
Switching voltage:	250 V AC1 / 24 V DC	
Min. switching power DC:	500 mW	
Mechanical service life:	3x10 <sup>7</sup>	
Electrical service life (AC1):	0.7x10 <sup>5</sup>	
<b>Control</b>		
RF command from the transmitter:	866 MHz, 868 MHz, 916 MHz	
Manual control:	button PROG (ON/OFF)	
Range in open space:	up to 200 m	
<b>Other data</b>		
Operating temperature:	-15 up to + 50 °C	
Working position:	any	
Mounting:	plug into a socket	
Protection:	IP30	
Overvoltage category:	III.	
Contamination degree:	2	
Dimensions:	60 x 120 x 80 mm	
Weight:	195 g	
Related standards:	EN 60669, EN 300 220, EN 301 489 R&TTE Directive, Order. No 426/2000 Coll. (Directive 1999/EC)	

- The switched socket with 1 output channel is used to control fans, lamps, heaters and appliances, which are connected by a power cord.
- They can be combined with detectors, controllers, iNELS RF Control or system components.
- Thanks to the socket design, installation is simple by direct insertion into the existing socket.
- It enables connection of the switched load up to 16 A (4 000 W).
- Multi-function design – button, impulse relay and time function of delayed ON or OFF with time setting of 2s-60 min.
- The switched socket may be controlled by up to 32 channels (1 channel represents 1 button on the controller).
- The programming button on the socket is also used for manual control of the output.
- Memory status can be pre-set in the event of a power failure.
- Range up to 200 m (in open space), if the signal is insufficient between the controller and unit, use the signal repeater RFRP-20 or protocol component RFIO<sup>2</sup> that support this feature.
- Communication frequency with bidirectional protocol iNELS RF Control<sup>2</sup> (RFIO<sup>2</sup>).

• Produced in 5 designs of sockets and plugs:

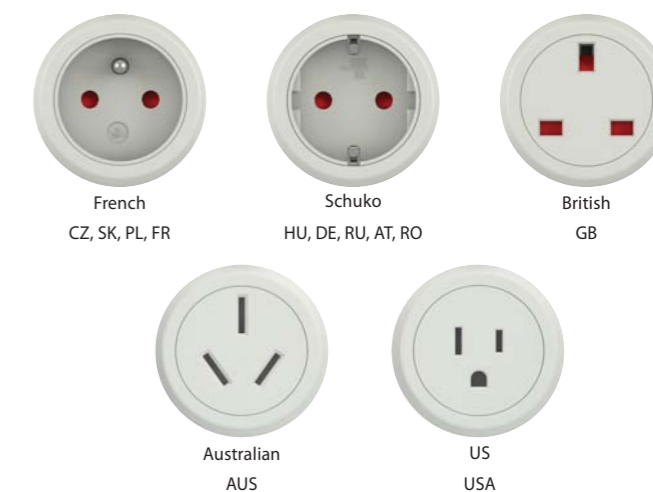

**Device description**

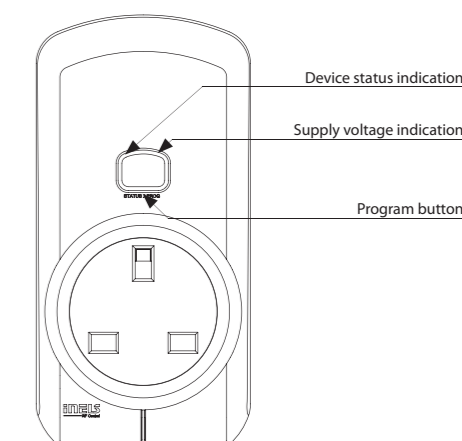

**Function**

For more information see p. 74.



- The switching unit with 1 output channel is used for controlling appliances, sockets or lights.
- They can be combined with detectors, controllers, iNELS RF Control or system components.
- The increased IP 65 protection is suited to mounting on the wall or in harsh environments such as the cellar, garage or bathrooms.
- It enables connection of the switched load up to 12 A (3.000 W).
- Multi-function design – button, impulse relay and time function of delayed ON or OFF with time setting of 2 s-60 min.
- The switching unit may be controlled by up to 25 channels (1 channel represents 1 button on the controller).
- The programming button on the unit is also used for manual control of the output.
- Memory status can be pre-set in the event of a power failure.
- For components it is possible to set the repeater function via the RFAF / USB service device.
- Range up to 200 m (in open space), if the signal is insufficient between the controller and unit, use the signal repeater RFRP-20 or protocol component RFIO<sup>2</sup> that support this feature.
- Communication frequency with bidirectional protocol iNELS RF Control<sup>2</sup> (RFIO<sup>2</sup>).

#### Device description

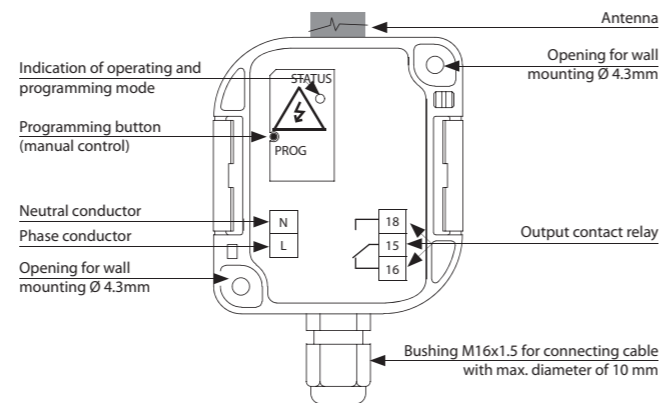

#### Function

For more information see p. 74.

#### Connection

RFUS-61/120 V  
RFUS-61/230 V

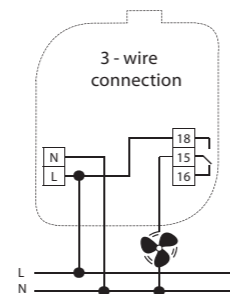

RFUS-61/24 V

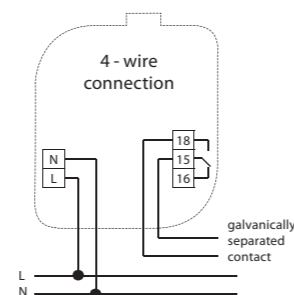
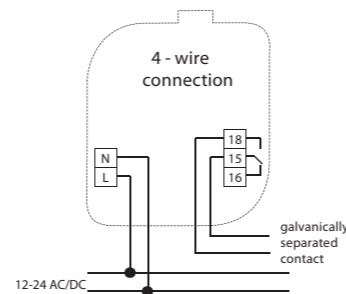

Technical parameters	RFUS-61/230V	RFUS-61/120V	RFUS-61/24V
Supply voltage:	230 V AC / 50-60 Hz	120 V AC / 60 Hz	12-24 V AC/DC 50-60 Hz
Apparent power:	5 VA / cos φ = 0.1	5 VA / cos φ = 0.1	-
Dissipated power:	0.6 W	0.6 W	0.6 W
Supply voltage tolerance:	+10 %; -15 %		
<b>Output</b>			
Rated current:	1 x switching (AgSnO <sub>2</sub> )		
Number of contacts:	12 A / AC1		
Switching power:	3000 VA / AC1, 384 W / DC		
Peak current:	30 A / <3 s		
Switching voltage:	250 V AC1 / 24 V DC		
Min. switching power DC:	500 mW		
Mechanical service life:	3x10 <sup>7</sup>		
Electrical service life (AC1):	0.7x10 <sup>5</sup>		
<b>Control</b>			
RF command from the transmitter:	866 MHz, 868 MHz, 916 MHz		
Manual control:	button PROG (ON/OFF)		
Range in open space:	up to 200 m		
<b>Other data</b>			
Operating temperature:	-15 up to + 50 °C		
Operating position:	any		
Mounting:	screws		
Protection:	IP65		
Overvoltage category:	III.		
Contamination degree:	2		
Cross-section of connecting wires (mm <sup>2</sup> ):	max. 1x 2.5, max. 2x 1.5 / with a hollow max. 1x 2.5		
Recommended power cord:	CYKY 3x1.5 (CYKY 4x1.5)		
Dimensions:	136 x 62 x 34 mm		
Weight:	146 g		
Related standards:	EN 60669, EN 300 220, EN 301 489 R&TTE Directive, Order. No 426/2000 Coll. (Directive 1999/EC)		



RFJA-12B/230V

Technical parameters	RFJA-12B/230V RFJA-32B/230V	RFJA-12B/120V RFJA-32B/120V	RFJA-12B/24V RFJA-32B/24V
Supply voltage:	230 V AC / 50 - 60 Hz	120 V AC / 60 Hz	5-24 V DC
Apparent input:	7 VA / cos φ = 0.1	7 VA / cos φ = 0.1	x
Dissipated power:	0.7 W	0.7 W	x
Power without load:	x	x	0.5 W
Power under load:	x	x	250 W
Supply voltage tolerance:	+10 %; -15 %		
<b>Input</b>			
Input:	2x switch or GND *		
<b>Output</b>			
Number of contacts:	2 x switching (AgSnO <sub>2</sub> )	x	x
Rated current:	8 A / AC1	x	x
Permanent current:	x	x	0.8 A
Switching power:	2000 VA / AC1	x	x
Peak current:	10 A / <3 s	x	1.5 A / <3 s
Switching voltage:	250 V AC1	x	x
Switching output voltage:	x	x	5-24 V DC**
Mechanical service life:	1x10 <sup>7</sup>	x	x
Electrical service life (AC1):	1x10 <sup>5</sup>	x	x
<b>Control</b>			
RF, by command from transmitter:	866 MHz, 868 MHz, 916 MHz		
Manual control:	PROG (STOP, ▲, STOP, ▼)		
Range in free space:	up to 100 m		
<b>Other data</b>			
Operating temperature:	-15 to + 50 °C		
Operating position:	any		
Mounting:	free at lead-in wires		
Protection:	IP30		
Overvoltage category:	III.		
Contamination degree:	2		
Terminals:	0.5 - 1 mm <sup>2</sup> *		
Terminals (CY wire, cross section):	4 x 0.75 mm <sup>2</sup>		
Length of terminals:	90 mm		
Dimensions:	49 x 49 x 21 mm	49 x 49 x 13 mm	
Weight:	46 g	22 g	
Related standards:	EN 60669, EN 300 220, EN 301 489 R&TTE Directive, Order. No 426/2000 Coll. (Directive 1999/EC)		

\* For RFJA-32B only

\*\* Identical with supply voltage

- The switching unit for blinds has 2 output channels used to control garage doors, gates, blinds, awnings, etc.
- It can be combined with Control or System units iNELS RF Control.
- The BOX design lets you mount it right in an installation box, a ceiling or motor drive cover.
- RFJA-12B/230V (120V):** connection of switched load 2x 8 A (2x 2000 W).
- RFJA-12B/24VDC:** contactless quiet switching.
- RFJA-32B/230V (120V):** connection of switched load 2x 8 A (2x 2000 W), with the ability to connect existing buttons.
- RFJA-32B/24VDC:** contactless quiet switching with the ability to connect existing buttons.
- Short presses of the controller enable tilting of lamellas, and a long press enables you to draw the blinds up or down to the end position.
- Each of the units may be controlled by up to 25 channels (1 channel represents one assigned controller).
- The programming button on the unit is also used for manual control of the output.
- For components it is possible to set the repeater function via the RFAF / USB service device.
- Range up to 100 m (in open space), if the signal is insufficient between the controller and unit, use the signal repeater RFRP-20 or protocol component RFIO<sup>2</sup> that support this feature.
- Communication frequency with bidirectional protocol iNELS RF Control<sup>2</sup> (RFIO<sup>2</sup>).

#### Device description

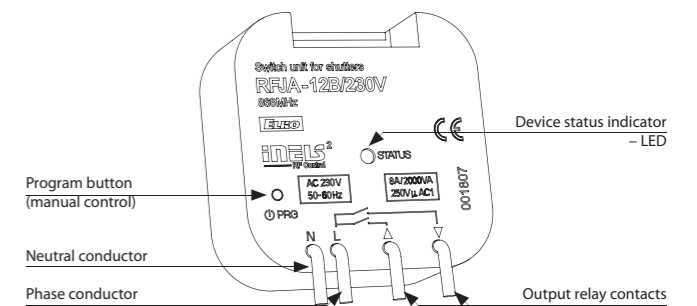

#### Function description

- When the control button is pressed for less than 2 seconds, shutters move up (▲) or down (▼).
- When the control button is pressed for more than 2 seconds, shutters move up (▲) or down (▼) until reaching the final position.

#### Connection

RFJA-12B/230V, RFJA-12B/120V  
(Without terminal blocks)  
RFJA-32B/230V, RFJA-32B/120V  
(With Terminal Blocks for switch Up  
and Down Buttons)

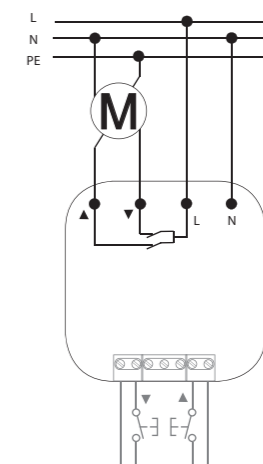

RFJA-12B/24VDC  
(Without terminal blocks)  
RFJA-32B/24VDC  
(With Terminal Blocks for switch Up  
and Down Buttons)

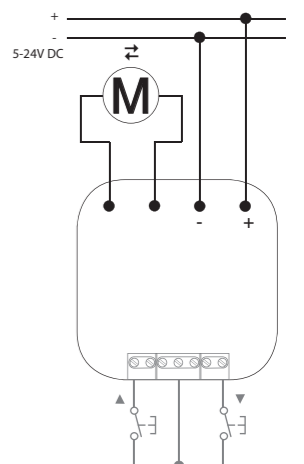



- The dimmer for LED strips is used for independent control of 3 single-color LED strips or one RGB LED strip.
- The expanded selection of control modes enables it to be combined with:
  - Detectors, Controllers and System units iNELS RF Control
  - control signal 0(1)-10 V
  - connecting to iNELS BUS using DAC converters.
- The unit's three-module design with switchboard mounting enables connection of dimmed load 3x 5 A, which represents:
  - single-color LED strip 7.2 W (ELKO Lighting) – 3x 8 m
  - RGB LED strip 14.2 W (ELKO Lighting) – 10 m.
- 6 light functions - smooth increase or decrease with time setting 2 s-30 min.
- When switched off, the set level is stored in the memory, and when switched back on, it returns to the most recently set value.
- The dimmer may be controlled by up to 32 channels (1 channel represents 1 button on the controller).
- The power supply of the unit is in the range of 12-24 V DC, and is indicated by a green LED.
- The package includes an internal antenna AN-I, in case of locating the unit in a metal switchboard, you can use the external antenna AN-E for better signal reception.
- Memory status can be pre-set in the event of a power failure.
- For components it is possible to set the repeater function via the RFAF / USB service device.
- Range up to 160 m (in open space), if the signal is insufficient between the controller and unit, use the signal repeater RFRP-20 or protocol component RFIO<sup>2</sup> that support this feature.
- Communication frequency with bidirectional protocol iNELS RF Control<sup>2</sup> (RFIO<sup>2</sup>).

Device description

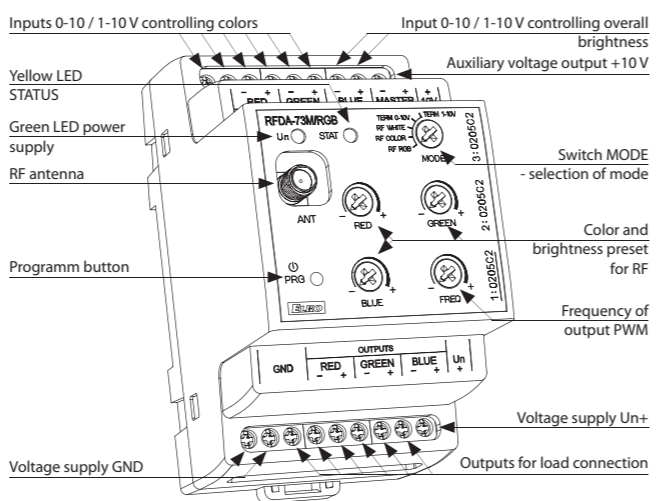

Function

For more information see p. 75.

Output variations

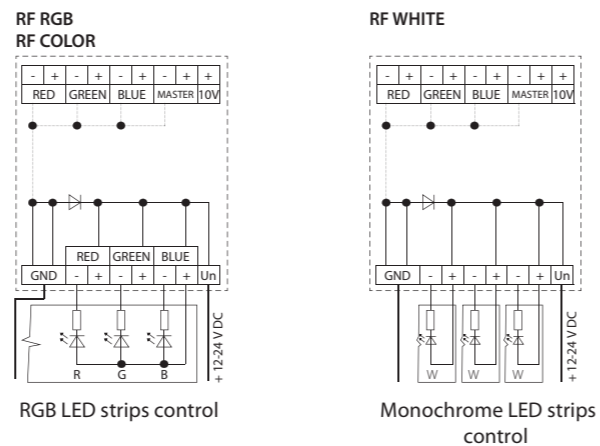

Control modes

RF RGB

Switch settings in MODE:

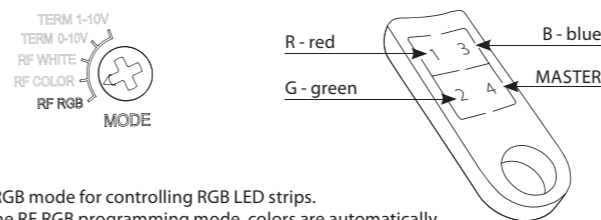

RF RGB mode for controlling RGB LED strips. In the RF RGB programming mode, colors are automatically assigned to individual transmitter buttons.

Note: The mode can be controlled by RF Touch, RF Pilot, RFWB-40/G, RF KEY, RFIM-40B, eLAN-RF-003 and eLAN-RF-Wi-003.

RF WHITE

Switch settings in MODE:

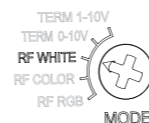

This works in a mode where it acts like three independent dimmers for 12-24 V. Each channel can be programmed independently of one another and has its own address.

Note: The mode can be controlled by RF Touch, RF Pilot, RFWB-20/G, RFWB-40/G, RF KEY, RFIM-20B, RFIM-40B, eLAN-RF-003 and eLAN-RF-Wi-003.

RF COLOR

Switch settings in MODE:

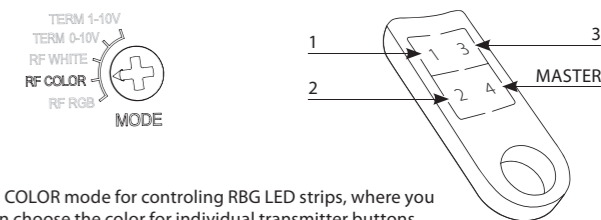

RF COLOR mode for controlling RGB LED strips, where you can choose the color for individual transmitter buttons. A long press of the button starts the color search mode. After releasing the button, the current color is set for the given button.

Note: The mode can be controlled by RF Touch, RF Pilot, RFWB-40/G, RF KEY RFIM-40B, eLAN-RF-003 and eLAN-RF-Wi-003.

TERM 0-10 V and TERM 1-10 V

Switch settings in MODE:



Modes TERM 0-10 V and TERM 1-10 V. Inputs 0-10 V and 1-10 V used to control one RGB LED strip or three independent single-color LED strips (see modes above) from the iNELS BUS System. For controlling, you can use the application iMM on the TV screen or the application iHC for smartphones and tablets.

Control options

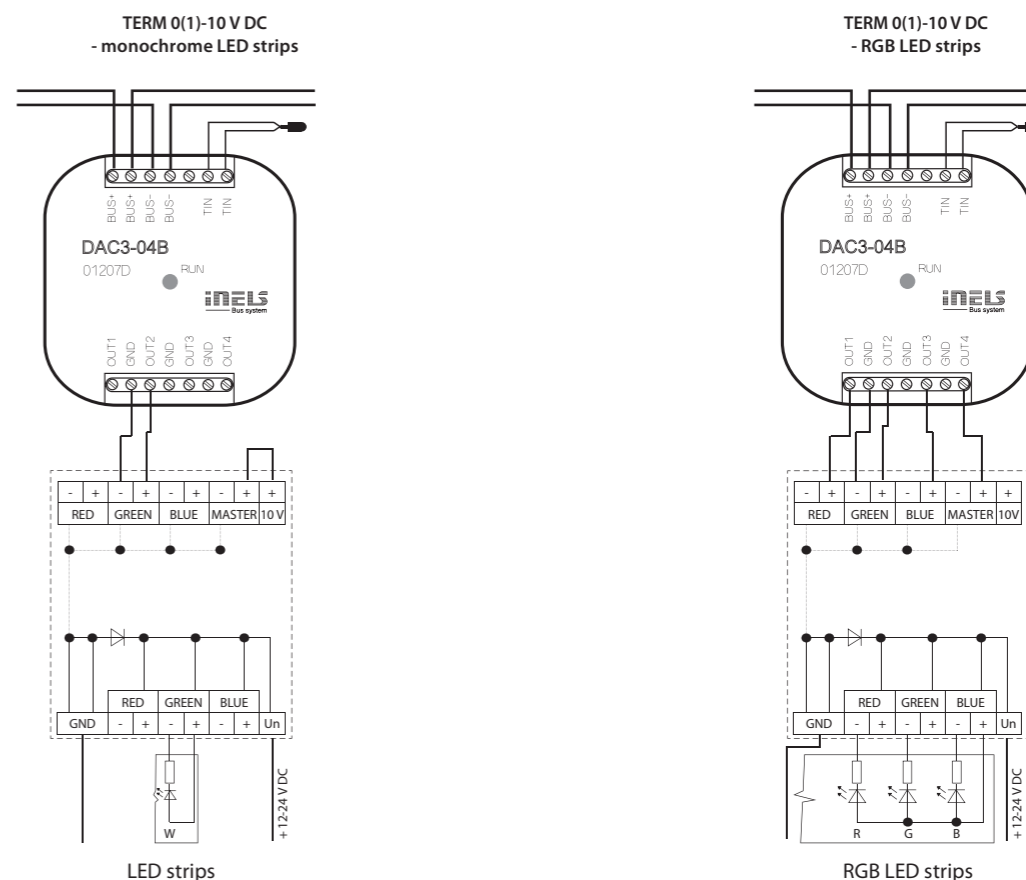

\* Max Tightening Torque for antenna connector is 0.56 Nm.



- The universal built-in dimmer is used to regulate light sources:
  - R – classic lamps
  - L – halogen lamps with wound transformer
  - C – halogen lamps with electronic transformer
  - ESL – dimmable energy-efficient fluorescent lamps
  - LED – LED light sources (230 V).
- They can be combined with detectors, controllers, iNELS RF Control or system components.
- The BOX design lets you mount it right in an installation box, a ceiling or light cover.
- 6 light functions - smooth increase or decrease with time setting 2 s-30 min.
- When switched off, the set level is stored in the memory, and when switched back on, it returns to the most recently set value.
- Thanks to setting the min. brightness by potentiometer, you will eliminate flashing of the LED and ESL light sources.
- The universal dimmer may be controlled by up to 25 channels (1 channel represents 1 button on the controller).
- Connection of the existing button on the control input „S“ enables combination of wireless control with classic (wired) control.
- The programming button on the controller is also used for manual control of the output.
- Memory status can be pre-set in the event of a power failure.
- For components it is possible to set the repeater function via the RFAF / USB service device.
- Range up to 160 m (in open space), if the signal is insufficient between the controller and unit, use the signal repeater RFRP-20 or protocol component RFIO<sup>2</sup> that support this feature.
- Communication frequency with bidirectional protocol iNELS RF Control<sup>2</sup> (RFIO<sup>2</sup>).

#### Device description

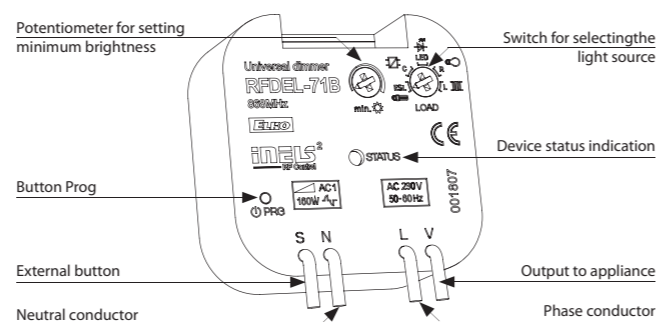

#### Function

For more information see p. 75.

#### Connection

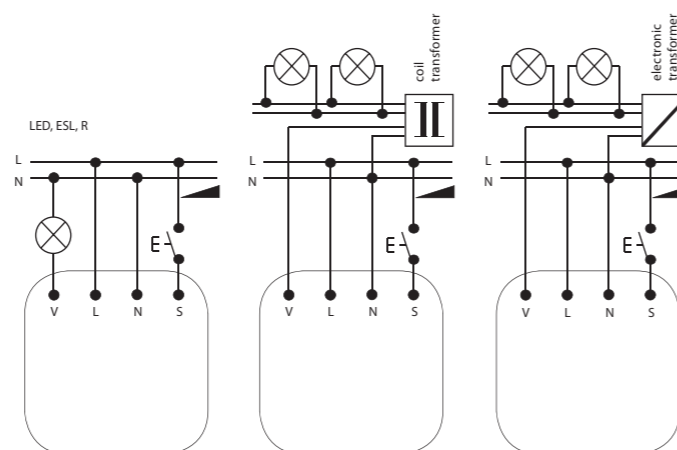

Technical parameters	RFDEL-71B/230V	RFDEL-71B/120V
Supply voltage:	230 V AC / 50 Hz	120 V AC / 60 Hz
Apparent power:	1.1 VA	1.1 VA
Dissipated power:	0.8 W	0.8 W
Supply voltage tolerance:	+10 / -15 %	
Connection:	4-wire, with "NEUTRAL"	
Dimmed load:	R,L,C, LED, ESL	
<b>Output</b>		
Contactless:	2 x MOSFET	
Load capacity:	160 W*	80 W*
<b>Control</b>		
RF command from the transmitter:	866 MHz, 868 MHz, 916 MHz	
Range in open space:	up to 160 m	
Manual control:	button PROG (ON/OFF), external button	
Glow lamp connection:	NO	
<b>Other data</b>		
Operating temperature:	-20 up to + 35°C	
Storage temperature:	-30 up to +70°C	
Operating position:	any	
Mounting:	free at lead-in wires	
Protection:	IP 30 under normal conditions	
Overvoltage category:	III.	
Contamination degree:	2	
Terminals (CY wire, Cross-section):	4 x 0.75 mm <sup>2</sup>	
Terminal length:	90 mm	
Dimensions:	49 x 49 x 21 mm	
Weight:	40 g	
Related standards:	EN 607 30-1 ED.2	

\* Due to the huge amount of type of light sources, the maximum load depends on internal construction of dimmable LED and ESL bulbs and their power factor  $\cos \varphi$ , capacity for power factor  $\cos \varphi=1$ . The power factor of dimmable LEDs and ESL bulbs ranges from  $\cos \varphi = 0.95$  up to 0.4. An approximate value of maximum load may be obtained by multiplying the load capacity of the dimmer by the power factor of the connected light source.

You can find the list of dimmable light sources here:



Technical parameters	RFDEL-71M/230V	RFDEL-71M/120V
Supply voltage:	230 V AC / 50 Hz	120 V AC / 60 Hz
Apparent power:	2.5 VA	1.1 VA
Dissipated power:	0.8 W	0.6 W
Supply voltage tolerance:	+10 / -15 %	
Dimmed load:	R,L,C, LED, ESL	
<b>Output</b>		
Contactless:	2 x MOSFET	
Load capacity:	600 W*	300 W*
Output for antenna:	SMA connector**	
<b>Control</b>		
RF command from the transmitter:	866 MHz, 868 MHz, 916 MHz	
Range in open space:	up to 160 m	
Manual control:	SW (ON/OFF) button	
External button:	max. 50 m cable	
Glow lamps connection:	NO	
Other control:	potentiometer or 0 (1) - 10 V	
<b>Other data</b>		
Operating temperature:	-20 up to + 35 °C	
Storage temperature:	-30 up to +70°C	
Operating position:	vertical	
Mounting:	DIN rail EN 60715	
Protection:	IP 20 under normal conditions	
Overvoltage category:	II.	
Contamination degree:	2	
Cross-section of connecting wires:	max. 1x 2.5, max. 2x 1.5 / with a hollow max. 1x 2.5	
Dimensions:	90 x 52 x 65 mm	
Weight:	125 g	
Related standards:	EN 607 30-1 ed.2	

\* Due to the huge amount of type of light sources, the maximum load depends on internal construction of dimmable LED and ESL bulbs and their power factor  $\cos \varphi$ , capacity for power factor  $\cos \varphi=1$ . The power factor of dimmable LEDs and ESL bulbs ranges from  $\cos \varphi = 0.95$  up to 0.4. An approximate value of maximum load may be obtained by multiplying the load capacity of the dimmer by the power factor of the connected light source.

You can find the list of dimmable light sources here <http://>



\*\* Max Tightening Torque for antenna connector is 0.56 Nm.

- The universal modular dimmer is used to regulate light sources:
  - R – classic lamps
  - L – halogen lamps with wound transformer
  - C – halogen lamps with electronic transformer
  - ESL – dimmable energy-efficient fluorescent lamps
  - LED – LED light sources (230 V).
- Control can be performed by:
  - Detectors, Controllers and System units iNELS RF Control
  - by control signal 0(1)-10 V
  - potentiometer
  - existing button in the installation.
- The unit's three-module design with switchboard mounting enables connection of a dimmed load of up to 600 W.
- 6 light functions - smooth increase or decrease with time setting 2 s-30 min.
- When switched off, the set level is stored in the memory, and when switched back on, it returns to the most recently set value.
- Thanks to setting the min. brightness by potentiometer, you will eliminate flashing of the LED and ESL light sources.
- The universal dimmer may be controlled by up to 32 channels (1 channel represents 1 button on the controller).
- The programming button on the controller is also used for manual control of the output.
- The package includes an internal antenna AN-I, in case of locating the unit in a metal switchboard, you can use the external antenna AN-E for better signal reception.
- Memory status can be pre-set in the event of a power failure.
- For components it is possible to set the repeater function via the RFAF / USB service device.
- Range up to 160 m (in open space), if the signal is insufficient between the controller and unit, use the signal repeater RFRP-20 or protocol component RFIO<sup>2</sup> that support this feature.
- Communication frequency with bidirectional protocol iNELS RF Control<sup>2</sup> (RFIO<sup>2</sup>).

#### Device description

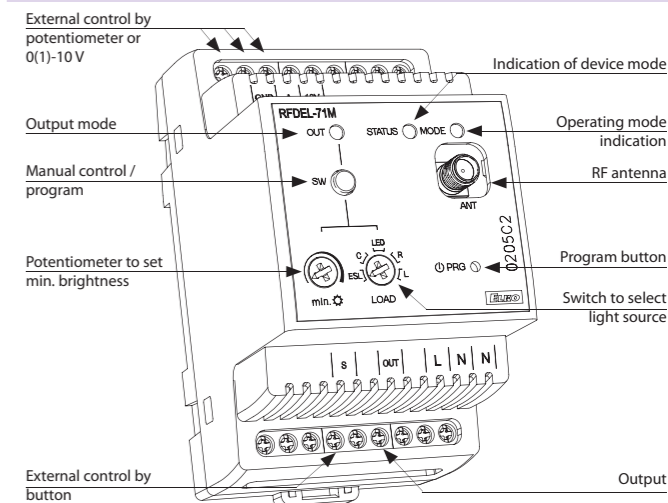

#### Function

For more information see p. 75.

#### Connection

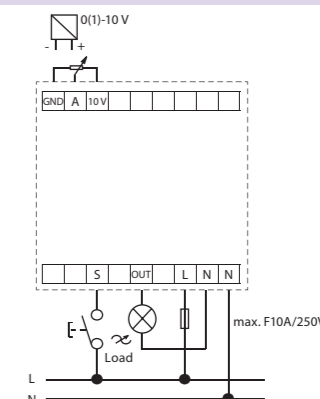

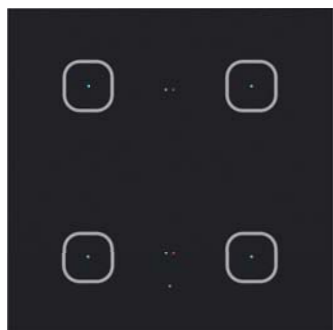

- Wireless glass designed switch with integrated dimming component which serves to regulate light sources:  
R – classic lamps  
L – halogen lamps with wound transformer  
C – halogen lamps with electronic transformer  
ESL – dimmable energy-efficient fluorescent lamps  
LED – LED light sources (230 V).
- 4 channel switch version allows you to control the integrated dimmer as well as other components of the installation.
- They can be combined with detectors, controllers, iNELS RF Control or system components.
- 6 light functions - smooth increase or decrease with time setting 2 s-30 min.
- When switched off, the set level is stored in the memory, and when switched back on, it returns to the most recently set value.
- Thanks to setting the min. brightness by potentiometer, you will eliminate flashing of the LED and ESL light sources.
- The universal dimmer may be controlled by up to 25 channels (1 channel represents 1 button on the controller).
- The programming button on the controller is also used for manual control of the output.
- Memory status can be pre-set in the event of a power failure.
- For components it is possible to set the repeater function via the RFAF / USB service device.
- Range up to 160 m (in open space), if the signal is insufficient between the controller and unit, use the signal repeater RFRP-20 or protocol component RFIO<sup>2</sup> that support this feature.
- Communication frequency with bidirectional protocol iNELS RF Control<sup>2</sup> (RFIO<sup>2</sup>).

#### Device description

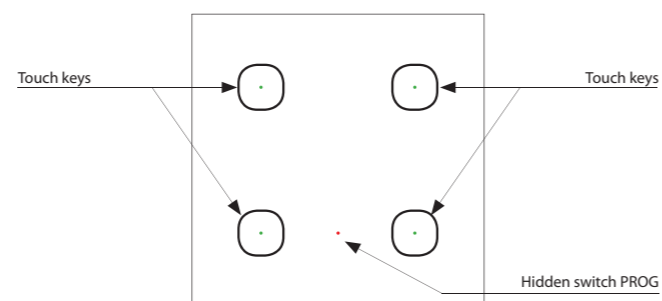

#### Function

For more information see p. 75.

#### Connection

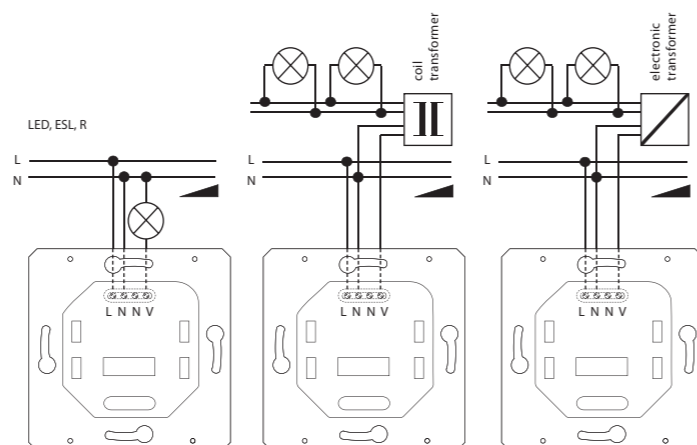

Technical parameters	RFDW-71/230V	RFDW-71/120V
Supply voltage:	230 V AC / 50 Hz	120 V AC / 60 Hz
Apparent power:	1.1 VA	1.1 VA
Dissipated power:	0.8 W	0.8 W
Supply voltage tolerance:	±10 %	
Dimmed load:	R,L,C, LED, ESL	
<b>Input</b>		
Temperature measuring:	YES, built-in temperature sensor	
Scope and accuracy of temp. measurement:	0.. +55°C; 0.3°C from the range	
<b>Output</b>		
Contactless:	2 x MOSFET	
Load capacity:	160 W*	80 W*
<b>Control</b>		
RF command from the detector:	866 MHz, 868 MHz, 916 MHz	
Manual control:	4 touch keys, PROG	
Indications touch keys:	red / green LED	
Indications PROG:	Colour adjustable prog. mode	
Range in open space:	up to 160 m	
<b>Connection</b>		
Terminals:	0.5 - 1 mm <sup>2</sup>	
<b>Other data</b>		
Operating temperature:	-20 up to + 35°C	
Storing temperature:	-30 up to +70°C	
Protection degree:	IP 20	
Overvoltage category:	II.	
Pollution degree:	2	
Operation position:	any	
Installation:	into installation box	
Dimensions:	94 x 94 x 36 mm	
Weight:	155 g	

\* Due to the huge amount of type of light sources, the maximum load depends on internal construction of dimmable LED and ESL bulbs and their power factor  $\cos \varphi$ , capacity for power factor  $\cos \varphi=1$ . The power factor of dimmable LEDs and ESL bulbs ranges from  $\cos \varphi = 0.95$  up to 0.4. An approximate value of maximum load may be obtained by multiplying the load capacity of the dimmer by the power factor of the connected light source.



Technical parameters	RFDSC-71/230V	RFDSC-71/120V
Supply voltage:	230 - 250 V / 50-60Hz	120 V AC / 60Hz
Apparent power:	1.1 VA	
Dissipated power:	0.8 W	
Supply voltage tolerance:	+10/ -15 %	
Dimming load:	R, L, C, LED, ESL	
<b>Output</b>		
Contactless:	2 x MOSFET	
Load capacity:	300 W*	150 W*
<b>Control</b>		
RF command from the transmitter:	866 MHz, 868 MHz, 916 MHz	
Range in open space:	up to 160 m	
Manual control:	button PROG (ON/OFF)	
<b>Other data</b>		
Operating temperature:	-20 up to + 35 °C	
Storage temperature:	-30 up to +70°C	
Working position:	any	
Mounting:	plug into a socket	
Protection:	IP30	
Overvoltage category:	III.	
Contamination degree:	2	
Dimensions:	60 x 120 x 80 mm	
Weight:	129 g	
Related standards:	EN 60669, EN 300 220, EN 301 489 R&TTE Directive, Order. No 426/2000 Coll. (Directive 1999/EC)	

\* Due to the huge amount of type of light sources, the maximum load depends on internal construction of dimmable LED and ESL bulbs and their power factor  $\cos \varphi$ , capacity for power factor  $\cos \varphi=1$ . The power factor of dimmable LEDs and ESL bulbs ranges from  $\cos \varphi = 0.95$  up to 0.4. An approximate value of maximum load may be obtained by multiplying the load capacity of the dimmer by the power factor of the connected light source.

You can find the list of dimmable light sources here:



- The dimmed socket is used to control light sources that are connected by power cord - especially lamps:  
R – classic lamps  
L – halogen lamps with wound transformer  
C – halogen lamps with electronic transformer  
ESL – dimmable energy-efficient fluorescent lamps  
LED – LED light sources (230 V).
- They can be combined with detectors, controllers, iNELS RF Control or system components.
- Thanks to the socket design, installation is simple by direct insertion into the existing socket.
- Output load 300 W.
- Multi-function 6 light functions - smooth increase or decrease with time setting 2 s-30 min.
- When switched off, the set level is stored in the memory, and when switched back on, it returns to the most recently set value.
- Thanks to setting the min. brightness by potentiometer, you will eliminate flashing of the LED and ESL light sources.
- The universal dimmer may be controlled by up to 32 channels (1 channel represents 1 button on the controller).
- The programming button on the socket is also used for manual control of the output.
- Memory status can be pre-set in the event of a power failure.
- Range up to 160 m (in open space), if the signal is insufficient between the controller and unit, use the signal repeater RFRP-20 or protocol component RFIO<sup>2</sup> that support this feature.
- Communication frequency with bidirectional protocol iNELS RF Control<sup>2</sup> (RFIO<sup>2</sup>).
- Produced in 5 designs of sockets and plugs:

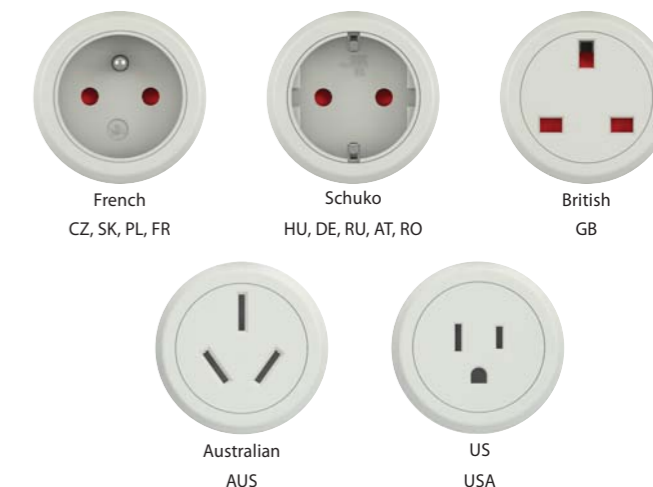

#### Device description

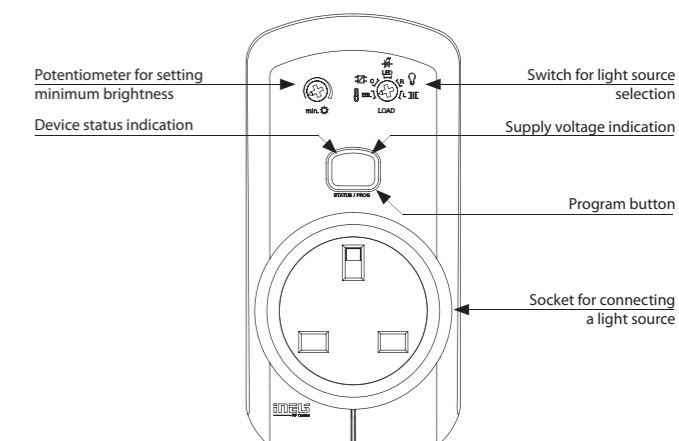

#### Function

For more information see p. 75.



- The analog controller with output 0(1)-10 V is used for:
  - a) dimming fluorescent lamps (using a dimmable ballast).
  - b) dimming LED panels (when using a suitable dimmed source up to 50 units LP-6060-3K/6K).
  - c) Control of thermal actuators (TELVA).
  - d) control of other controllers (e.g. performance dimmers DIM-6).
- They can be combined with detectors, controllers, iNELS RF Control or system components.
- The BOX design lets you mount it right in an installation box, a ceiling or light cover.
- Potential free analog output 10 mA, contact relay 16 A.
- 6 light functions - smooth increase or decrease with time setting 2 s-30 min.
- When switched off, the set level is stored in the memory, and when switched back on, it returns to the most recently set value.
- The analog controller may be controlled by up to 25 channels (1 channel represents 1 button on the controller).
- The programming button on the controller is also used for manual control of the output.
- The unit power supply is in the range 110-230 V AC.
- Memory status can be pre-set in the event of a power failure.
- For components it is possible to set the repeater function via the RFAF / USB service device.
- Range up to 200 m (in open space), if the signal is insufficient between the controller and unit, use the signal repeater RFRP-20 or protocol component RFIO<sup>2</sup> that support this feature.
- Communication frequency with bidirectional protocol iNELS RF Control<sup>2</sup> (RFIO<sup>2</sup>).

#### Device description

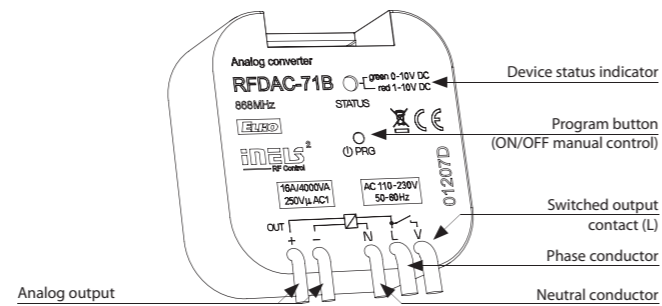

#### Function

For more information see p. 75.

#### Connection

Connection example:  
dimming of fluorescent tubes  
with dimmable ballast

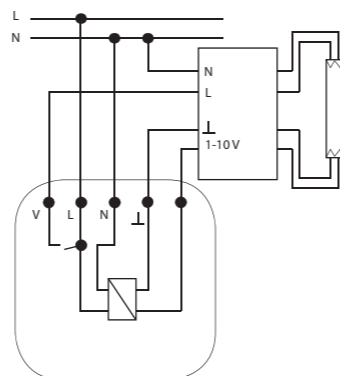

Connection  
example:  
with thermo  
valve

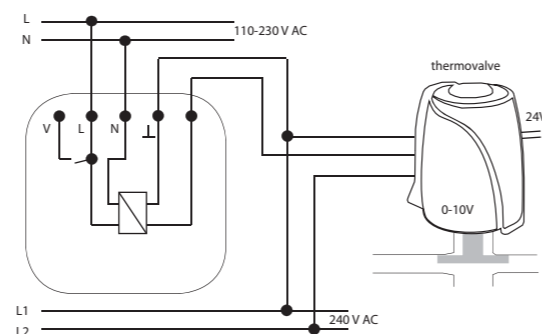

Technical parameters		RFDAC-71B
Supply voltage:		110 - 230 V AC / 50 - 60 Hz
Apparent input:		3 VA
Dissipated power:		1.2 W
Supply voltage tolerance:		+10 / -15 %
Potential-free analog output / max. current:		0(1)-10 V / 10 mA
<b>Control</b>		
RF command from the transmitter:		866 MHz, 868 MHz, 916 MHz
Manual control:		button PROG (ON/OFF)
Range in free space:		up to 200 m
Minimum control distance:		20 mm
Contact relay:		1x AgSnO <sub>2</sub> , switches the phase conductor
Rated current:		16 A / AC1
Switching power:		4000 VA / AC1
Switching voltage:		250 V AC1
Mechanical service life:		3x10 <sup>7</sup>
Electrical service life:		0.7x10 <sup>5</sup>
Indication:		red LED / green LED
Output selection:		0(1)-10V / PROG button
<b>Other data</b>		
Operating temperature:		-15 to + 50 °C
Operating position:		any
Mounting:		free at lead-in wires
Protection:		IP30
Overvoltage category:		III.
Contamination degree:		2
Terminals (CY wire, cross-section):		3 x 0.75 mm <sup>2</sup> , 2 x 2.5 mm <sup>2</sup>
Length of terminals:		90 mm
Dimensions:		49 x 49 x 21 mm
Weight:		52 g
Related standards:		EN 60669, EN 300 220, EN 301 489 R&TTE Directive, Order. No 426/2000 Coll. (Directive 1999/EC)



Technical parameters		RF-RGB-LED-550
Supply voltage:		100-240V AC 50/60 Hz
Maximum power:		9 W
Power factor:		<0.6
<b>Output</b>		
Lighting power:		6 W
Luminous flux:		550Lm
Color temperature:		RGB
Brightness regulation:		0-100%
Durability:		30000 hours
<b>Controlling</b>		
RF command from the transmitter:		866 MHz, 868 MHz, 916 MHz
Free space range:		up to 20 m
<b>Other data</b>		
Operating temperature:		0 to + 50 °C
Storage temperature:		-30 to + 70 °C
Connection:		socket E27
Operating position:		any
Dimension:		65 x 115 mm
Weight:		150 g

#### RF-RGB-LED-550

- The colored lamp with RF module enables you to create an atmosphere for reading, watching a movie, hosting a party with friends, etc.
- The lamp has an implemented wireless unit, which receives commands from system units of iNELS RF Control (link) and sends a signal for visualization of the current status ON/OFF, brightness.
- Luminous flux up to 550 Lm, with power 9 W and life of 30 000 hours.
- RGB lamp function:
  - colored light scenes
  - option of setting brightness in a range of 0-100%
  - circus mode, used for automatic blending of colors
- When switched off, the set level is stored in the memory, and when switched back on, it returns to the most recently set value.
- Assembly directly in your existing light with base E27.
- The power supply of the lamp is in the range 100-240 V AC.
- Range up to 20 m (in open space); if the signal is insufficient between the controller and unit, use the signal repeater RFRP-20 or protocol component RFIO<sup>2</sup> that support this feature.
- Communication frequency with bidirectional protocol iNELS RF Control.

#### Dimension

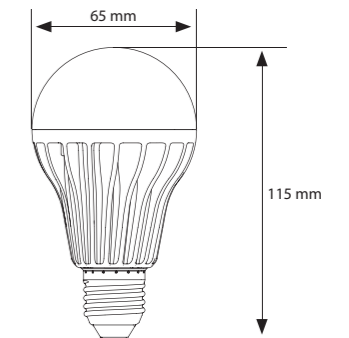



- The wireless twilight dimmer measures the light intensity and based on a set value, it sends the command to switch on the lights or pull the blinds up or down.
- It can be combined with multifunctional switching units and blind switches.
- The increased IP65 protection is suited to mounting on the wall or in harsh environments.
- Integrated sensor for measuring illumination, settable in 3 ranges 1-100,000 lx.
- Selection of function:
  - a) twilight switch – automatically switches on upon a decrease in ambient light intensity, switches off upon an increase (appropriate for garden lights, advertisements, public lighting, etc.).
  - b) light switch – automatically switches on upon an increase in ambient light intensity, switches off upon a decrease (appropriate for offices, restaurants, rooms, etc.).
- Settable delay up to 2 minutes to eliminate unwanted switching caused by surrounding influences.
- The twilight switch may control up to 32 units in the installation.
- The programming button on the regulator is used for:
  - a) setting a function with a switching or blind unit
  - b) ascertaining battery status
  - c) ascertaining signal quality between the unit and dimmer.
- Battery power (1.5 V / 2 x AAA - included in supply) with battery life of around 2 years based on the number of controlled units.
- Range up to 160 m (in open space), if the signal is insufficient between the controller and unit, use the signal repeater RFRP-20 or protocol component RFIO<sup>2</sup> that support this feature.
- Communication frequency with bidirectional protocol iNELS RF Control.

#### Device description

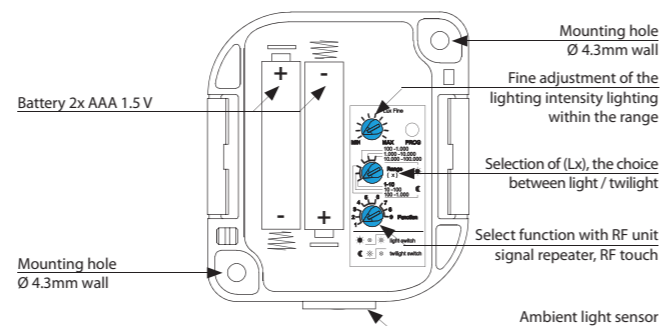

Technical parameters	RFSOU-1
Power supply:	2 x 1.5 battery AAA
Battery life:	Aprx. 2 years, according to the number of controlled units
<b>Setting the range of light levels</b>	
Function ☾ (twilight switch)	
- Range 1:	1 ... 10 lx
- Range 2:	10 ... 100 lx
- Range 3:	100 ... 1.000 lx
Function ☀ (light switch)	
- Range 1:	100 ... 1 000 lx
- Range 2:	1 000 ... 10 000 lx
- Range 3:	10 000 ... 100 000 lx
Function setting:	rotary switch
The level of lighting gently:	0.1 ... 1 x range
Fine adjustment of lighting levels:	potentiometer
The time delay t:	0 / 1 min. / 2 min.
Setting the delay time t:	rotary switch
<b>Output</b>	
Sending RF communication packet:	866 MHz, 868 MHz, 916 MHz
Range in free space:	up to 160 m
<b>Other data</b>	
Working temperature:	-20 to +50°C*
Storage temperature:	-30 to +70°C
Operating position:	sensor side down
Protection:	IP65
Degree of pollution:	2
Dimension:	72 x 62 x 34 mm
Weight:	104 g
Standards:	EN 60730-1, EN 300 220, EN 301 489 R&TTE Directive, Order. No 426/2000 Coll. (Directive 1999/EC)

\*Note: pay attention to the operating temperature of batteries.



Technical parameters	RFATV-1
Supply voltage:	2x 1.5 V batteries AA
Battery life:	1 year
<b>Control</b>	
Broadcasting frequency:	866 MHz, 868 MHz, 916 MHz
RF command from the transmitter:	RF Touch, eLAN-RF, RFTC-100/G
Range in open space:	up to 100 m
<b>Other data</b>	
Operating temperature:	0 up to +50 °C
Working position:	any
Protection:	IP40
Dimensions:	65 x 65 x 48 mm
Thermostat end:	M 30 x 1.5
Piston stroke:	max. 4 mm
Controlling force:	max. 100 N
Related standards:	EN 60730

- The wireless thermostat measures room temperature by internal sensor; based on a set program in the system unit, it opens / closes the radiator valve.
- It can be combined with one of three system units: smart RF box eLAN-RF, wireless controller RFTC-100/G or touch unit RF Touch.
- It measures temperature in a range of 0 .. +32°C and sends it to the system unit in regular 5-min. intervals.
- Monitoring function Open window, where upon a sudden change in temperature, it shuts the valve for a preset period.
- Setting the hysteresis and off set is performed in the system unit or application.
- Low battery indicator on the display of the system unit or in the application.
- Mounting directly on the valve of the heater (radiator).
- Battery power (1.5 V / 2x AA - included in supply) with battery life of around 1 year based on frequency of use.
- Range up to 100 m (in open space), if the signal is insufficient between the controller and unit, use the signal repeater RFRP-20 or protocol component RFIO<sup>2</sup> that support this feature.
- Communication frequency with bidirectional protocol iNELS RF Control.
- Package includes: adapters Danfoss RAV, RA, RAVL; 2x batteries AA 1.5 V; key.

#### Device description

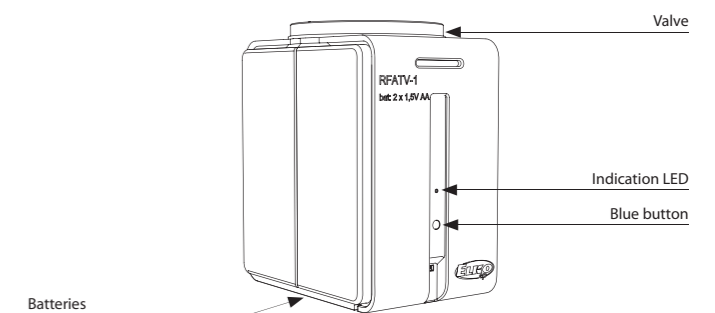

#### Adapters (is included)

Type of valve	Type of adapter
Danfoss RAV (the valve plunger must be fitted with the enclosed pin):	
Danfoss RA:	
Danfoss RAVL:	





- The temperature sensor measures the temperature by internal sensor, which it sends in regular intervals to the system unit. Option of connecting an external sensor to the terminals THERM.
- The temperature sensor can be used in one of two ways:
  - For displaying the measured temperature (from a garage, balcony, cellar, garden) on the display of the system unit or in the application.
  - For measuring temperature, which it sends to the system unit, which may control the heating circuit based on the set temperature program (electric underfloor heating, air conditioning, boiler, etc.).
- It measures temperature in a range of -20-50 °C and sends it to the system unit in regular 5-min. intervals. It sends a signal upon sudden temperature change within 1 min.
- Battery power (3 V / 1x CR 2477 - included in supply) with battery life of around 1 year based on frequency of use.
- The temperature sensor can be placed anywhere thanks to battery power.
- Range up to 160 m (in open space), if the signal is insufficient between the controller and unit, use the signal repeater RFRP-20 or protocol component RFIO<sup>2</sup> that support this feature.
- Communication frequency 868 MHz with bidirectional protocol iNELS RF Control.
- External sensor TC (0 ..+70 °C) or TZ (-40 ..+125 °C) for length of 0.11 m, 3 m, 6 m, 12 m.

#### Device description

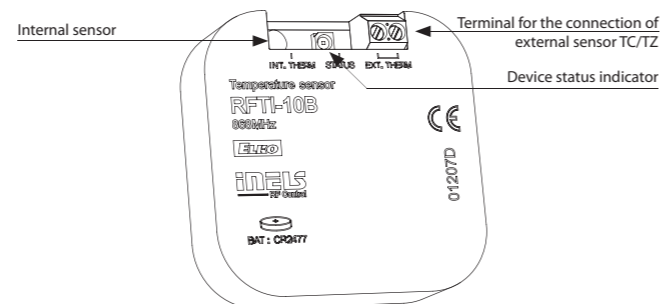

#### Recommended external sensors

For more information see p. 69.

#### Sensor location



Technical parameters		RFTI-10B
Supply voltage:	1x 3 V CR 2477 battery	
Battery life:	1 year	
Transmission indication / function:	red LED	
Temperature measurement:	1x internal NTC thermistor 1x external TZ/TC temperature sensor input	
Temp. measurement range and accuracy:	-20 to +50°C ; 0.5 °C in the range	
<b>Output</b>		
Transmitter frequency:	866 MHz, 868 MHz, 916 MHz	
Signal transmission method:	unidirectionally addressed message	
Range in free space:	up to 160 m	
<b>Other data</b>		
Operating temperature:	-10 to +50 °C	
Operating position:	any	
Mounting:	glued / free-standing	
Protection:	IP30	
Contamination degree:	2	
Dimensions:	49 x 49 x 13 mm	
Weight:	45 g	
Related standards:	EN 60669, EN 300 220, EN 301 489 R&TTE Directive, Order. No 426/2000 Coll. (Directive 1999/EC)	



Technical parameters		RFSTI-11B/230V	RFSTI-11B/120V	RFSTI-11B/24V
Supply voltage:	230 V AC / 50-60 Hz		120 V AC / 60 Hz	12-24 V AC/DC
Apparent input:	7 VA / cos φ = 0.1		7 VA / cos φ = 0.1	-
Dissipated power:	0.7 W		0.7 W	0.7 W
Supply voltage tolerance:	+10 %; -15 %			
Temperature measurement input:	1x external TZ/TC temperature sensor input *			
Temp. measurement range and accuracy:	-20 to +50 °C; 0.5 °C of the range			
<b>Output</b>				
Number of contacts:	1x switching (AgSnO <sub>2</sub> )			
Rated current:	16 A / AC1			
Switching power:	4000 VA / AC1, 384 W / DC			
Peak current:	30 A / <3 s			
Switching voltage:	250 V AC1 / 24 V DC			
Max. DC switching power:	500 mW			
Mechanical service life:	3x10 <sup>7</sup>			
Electrical service life (AC1):	0.7x10 <sup>5</sup>			
<b>Control</b>				
RF command from the transmitter:	866 MHz, 868 MHz, 916 MHz			
Range in open space:	up to 160 m			
<b>Other data</b>				
Operating temperature:	-15 to + 50 °C			
Status indication:	red LED			
Operating position:	any			
Mounting:	free at lead-in wires			
Protection:	IP 30			
Overvoltage category:	III.			
Contamination degree:	2			
Outlets (CY wire, cross-section, length):	2 x 0.75 mm <sup>2</sup> , 2 x 2.5 mm <sup>2</sup> , 90 mm			
Dimensions:	49 x 49 x 21 mm			
Weight:	46 g			
Related standards:	EN 60669, EN 300 220, EN 301 489 R&TTE Directive, Order. No 426/2000 Coll. (Directive 1999/EC)			

\* Temperature sensor input is at the supply voltage potential.

- The temperature unit measures the temperature by external sensor, and controls the heating circuit (electric underfloor heating, air conditioning, boiler, etc.).
- These can be combined with system units: smart RF box eLAN-RF, wireless controller RFTC-50/G or touch unit RF Touch.
- It measures temperature in a range of -20..50 °C and sends it to the system unit in regular 5-min. intervals. It sends a signal upon sudden temperature change.
- Setting the heat/cool function, hysteresis and off set is performed in the system unit or application.
- The BOX design lets you mount it right in an installation box, a ceiling or controlled appliance cover.
- It enables connection of the switched load up to 16 A (4 000 W).
- For components it is possible to set the repeater function via the RFAF / USB service device.
- Range up to 160 m (in open space), if the signal is insufficient between the controller and unit, use the signal repeater RFRP-20 or protocol component RFIO<sup>2</sup> that support this feature.
- Communication frequency with bidirectional protocol iNELS RF Control<sup>2</sup> (RFIO<sup>2</sup>).
- External sensor TC (0 ..+70 °C) or TZ (-40 ..+125 °C) for length of 0.11 m, 3 m, 6 m, 12 m.

#### Device description

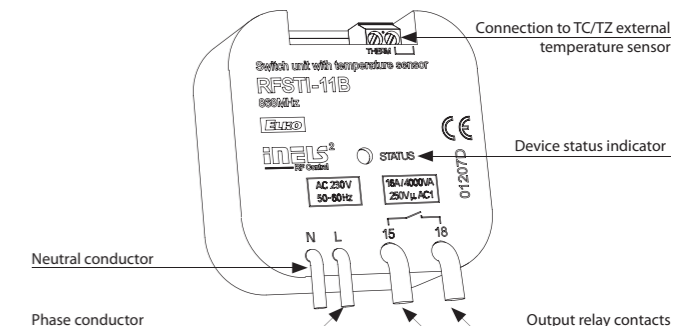

#### Recommended external sensors

For more information see p. 69.

#### Connection

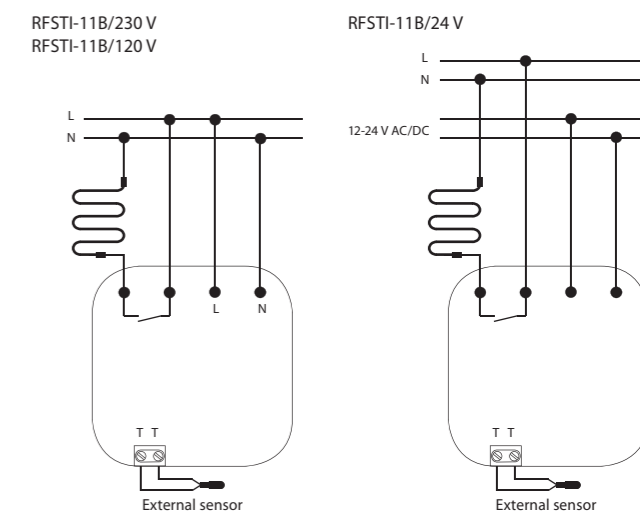

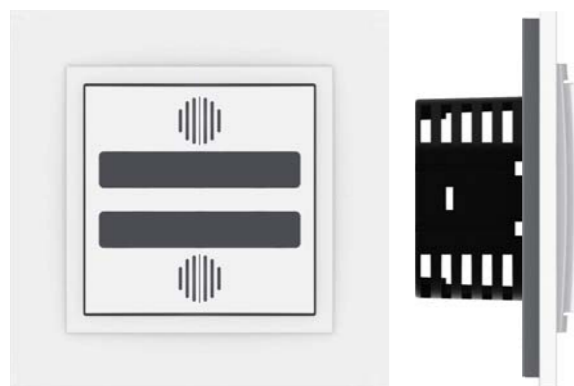

- The thermo-regulation drive measures the (internal / external) temperature by external sensor, and controls the heating circuit (electric underfloor heating, air conditioning, boiler, etc.).
- Function:
  - Internal – measures temperature by internal sensor and sends it to the system unit.
  - External – measures temperature by external sensor and sends it to the system unit.
  - Combo – measure room temperature by internal sensor and monitors critical floor temperature by external sensor.
- These can be combined with system units: smart RF box eLAN-RF or touch unit RF Touch.
- Manual control of temperature directly using buttons on the unit, where by pressing the upper button, a command is sent for automatic switching to the mode Party (preset temperature), and a press of the lower button sends a signal for switching to energy-saving mode (the change in temperature applies until the next set change of the heating program).
- Indication of status switched ON/OFF is provided by (red/blue) LED, which is found under the transparent cover of the temperature unit.
- It measures temperature in a range of -20-50 °C and sends it to the system unit in regular 5-min. intervals. It sends a signal upon sudden temperature change within 1 min.
- Setting the heat/cool function, hysteresis and off set is performed in the system unit or application.
- Switch design (design LOGUS<sup>90</sup>) offers mounting in an installation box.
- It enables connection of the switched load up to 8 A (2 000 W).
- The unit power supply is 110-230 V AC.
- For components it is possible to set the repeater function via the RFAF / USB service device.
- Range up to 160 m (in open space), if the signal is insufficient between the controller and unit, use the signal repeater RFRP-20 or protocol component RFIO<sup>2</sup> that support this feature.
- Communication frequency with bidirectional protocol iNELS RF Control<sup>2</sup> (RFIO<sup>2</sup>).
- Color combination of heating unit in design of frames LOGUS<sup>90</sup> (plastic, glass, wood, metal, stone).
- External sensor TC (0 ..+70 °C) or TZ (-40 ..+125 °C) for length of 0.11 m, 3 m, 6 m, 12 m.

#### Device description

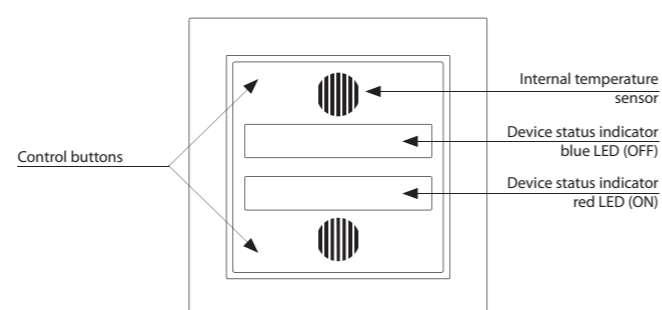

#### Recommended external sensors

For more information see p. 69.

#### Connection

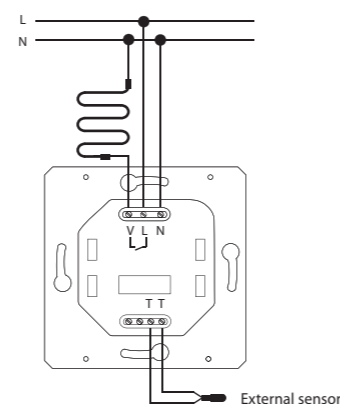

Technical parameters		RFSTI-11/G
Supply voltage:	110-230 V AC / 50 - 60 Hz	
Apparent input:	7 VA / $\cos \varphi = 0.1$	
Dissipated power:	0.7 W	
Supply voltage tolerance:	+10 %; -15 %	
Temperature measurement input:	1x internal NTC thermistor; 1x external TZ/TC temperature sensor input	
Temp. measurement range and accuracy:	-20 to +50 °C; 0.5 °C of the range	
Output		
Number of contacts:	1x switching (AgSnO <sub>2</sub> )	
The max. Current relay load:	1A*	
Rated current:	8A / AC1	
Switching power:	2000 VA / AC1; 240 W / DC1	
Peak current:	30 A / <3 s	
Switching voltage:	250 V AC1 / 24 V DC	
Max. DC switching power:	500 mW	
Mechanical service life:	3x10 <sup>7</sup>	
Electrical service life (AC1):	0.7x10 <sup>5</sup>	
Control		
RF command from the transmitter:	866 MHz, 868 MHz, 916 MHz	
Manual control:	buttons	
Range in open space:	up to 160 m	
Other data		
Operating temperature:	-15 to +50 °C	
Status indication:	blue, red LED	
Operating position:	vertical	
Mounting:	in an installation box	
Protection:	IP 20	
Overvoltage category:	III.	
Contamination degree:	2	
Cross-section of connecting cables (mm <sup>2</sup> ):	max. 1x 2.5, max. 2x 1.5 / with a hollow max. 1x 2.5	
Dimensions:	84 x 89 x 42 mm	
Weight:	68 g	
Related standards:	EN 60669, EN 300 220, EN 301 489 R&TTE Directive, Order. No 426/2000 Coll. (Directive 1999/EC)	

\* When using larger loads, it is recommended to use the VS116B or VS116 auxiliary relays to avoid interfering with the internal temperature sensor.



Flat design - the depth of the device is only 20 mm!

Technical parameters		RFTC-10/G		
Supply voltage:	2 x 1.5 V AAA battery			
Battery life:	1 year			
Temperature offset:	2 buttons V / ^			
Offset:	± 5 °C			
Display:	LCD, characters / see Display description			
Backlighting:	YES / active – blue			
Transmission indication / function:	symbols			
Temperature measurement input:	1x internal sensor			
Temp. measurement range and accuracy:	0 to +55 °C; 0.3 °C of the range			
Control				
Transmitter frequency:	866 MHz, 868 MHz, 916 MHz			
Signal transmission method:	bidirectionally addressed message			
Range in free space:	up to 100 m			
Minimum control distance:	20 mm			
Other data				
Max. number of control.	1			
RFS-A-6x:	1			
Program:	x			
Operating temperature:	0 to +55 °C			
Operating position:	wall-mounted			
Mounting:	glue / screws			
Protection:	IP20			
Contamination degree:	2			
Dimensions frame				
- plastic:	85 x 85 x 20 mm			
- metal, glass, wood, granite:	94 x 94 x 20 mm			
Weight:	66 g (without batteries)			
Related standards:	EN 60669, EN 300 220, EN 301 489 R&TTE Directive, Order. No 426/2000 Coll. (Directive 1999/EC)			
Compatibility				
RF Touch	eLAN-RF	RFS-A-6 x	RFSTI-11B	RFATV-1
✓	✓	✓	-	-

- The simple controller in design LOGUS<sup>90</sup> measures the room temperature by internal sensor, and based on the set temperature, it sends a command to control heating.
- The temperature controller can be used in one of two ways:
  - For controlling an additional heat source (heater, oil radiator, radiant panel) with multi-function switching units RFS-A-6x, RFUS-61 or RFSC-61.
  - For sufficient temperature correction (± 5 °C) over the course of the program set in the system unit change in temperature applies until the following set change of the heating program in the system unit).
- Manual control by buttons on the unit.
- Range of measured temperature 0-55 °C.
- The backlit LCD display displays the current and set temperature, status (ON/OFF), battery status, etc.
- Battery power (1.5 V / 2x AAA - included in supply) with battery life of around 1 year based on frequency of use.
- The flat rear side of the device enables its placement anywhere in the room where you wish to measure temperature.
- Range up to 100 m (in open space), if the signal is insufficient between the controller and unit, use the signal repeater RFRP-20 or protocol component RFIO<sup>2</sup> that support this feature.
- Communication frequency with bidirectional protocol iNELS RF Control.
- Color combination of heating unit in design of frames LOGUS<sup>90</sup> (plastic, glass, wood, metal, stone).

#### Device description

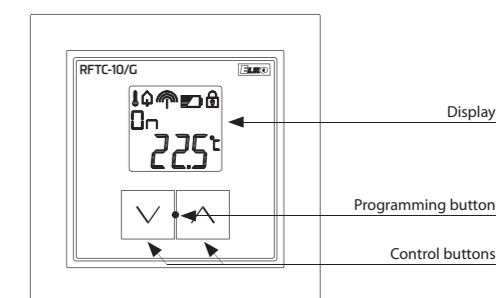

#### Display description

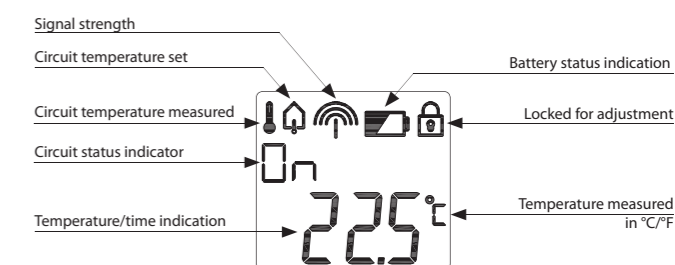



Flat design - the depth of the device is only 20 mm!

- The wireless controller in design LOGUS<sup>90</sup> measures the room temperature by internal sensor, and based on the set temperature, it sends a command for heating / cooling.
- Option of setting a daily/weekly automatic control program.
- The temperature controller can be used in one of two ways:
  - For controlling an additional heat source (heater, oil radiator, radiant panel) with multi-function switching units RFSA-6x, RFUS-61 or RFSC-61.
  - For control of floor heating, when the internal sensor scans the room temperature, and based on the value, controls the heating unit RFSTI-11B, which monitors the critical floor value by external sensor.
- Manual control by buttons on the unit.
- Range of measured temperature 0-55 °C.
- The backlit LCD display displays the current and set temperature, status (ON/OFF), battery status, day of the week, current time, etc.
- Battery power (1.5 V / 2x AAA - included in supply) with battery life of around 1 year based on frequency of use.
- The flat rear side of the device enables its placement anywhere in the room where you wish to measure temperature.
- Range up to 100 m (in open space), if the signal is insufficient between the controller and unit, use the signal repeater RFRP-20 or protocol component RFIO<sup>2</sup> that support this feature.
- Communication frequency with bidirectional protocol iNELS RF Control.
- Color combination of temperature unit in design of frames LOGUS<sup>90</sup> (plastic, glass, wood, metal, stone).

#### Device description

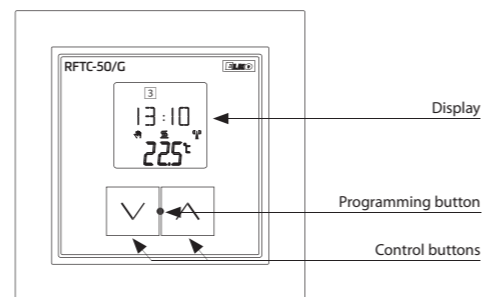

#### Display description

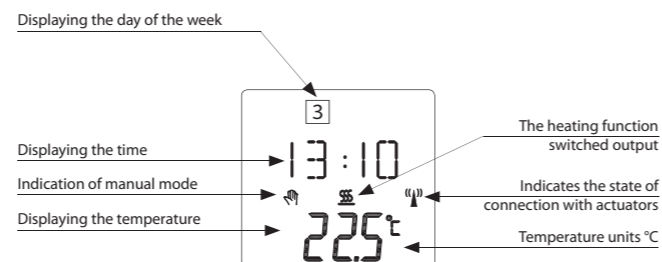

Technical parameters		RFTC-50/G
Supply voltage:	2x 1.5 V AAA battery	
Battery life:	up to 1 year according to the number of controlling actuators	
Temperature offset:	2 buttons V / ^	
Offset:	± 5 °C	
Display:	LCD, characters / see Display description	
Backlighting:	YES / active - blue	
Transmission indication / function:	symbols	
Temperature measurement input:	1x internal sensor	
Temp. measurement range and accuracy:	0 to +55 °C; 0.3 °C of the range	

Control	
Transmitter frequency:	866 MHz, 868 MHz, 916 MHz
Signal transmission method:	bidirectionally addressed message
Range in free space:	up to 100 m
Minimum control distance:	20 mm

Other data	
Max. number of control.	4
RFSA-6x:	4
Program:	Weekly
Operating temperature:	0 to + 55 °C
Operating position:	on the wall
Mounting:	by gluing / screwing
Protection:	IP20
Contamination degree:	2
Dimensions frame	
- plastic:	85 x 85 x 20 mm
- metal, glass, wood, granite:	94 x 94 x 20 mm
Weight:	66 g (without batteries)
Related standards:	EN 60669, EN 300 220, EN 301 489 directive R&TTE Directive, Order. No 426/2000 Coll. (Directive 1999/EC)

Compatibility				
RF Touch	eLAN-RF	RFSA-6 x	RFSTI-11B	RFATV-1
-	-	✓	✓	-



Technical parameters		RFTC-100/G
Supply voltage:	100-230 V AC / 50 - 60 Hz	
Apparent input:	3 VA / cos φ = 0.1	
Dissipated power:	0.3 W	
Supply voltage tolerance:	+10 %; -15 %	
Temperature offset:	2 buttons V / ^	
Offset:	± 5 °C	
Display:	LCD, characters / see Display description	
Backlighting:	YES / active - blue	
Transmission indication / function:	symbols	
Temperature measurement input:	1x internal sensor	
Temp. measurement range and accuracy:	0 to +55 °C; 0.3 °C of the range	

Control	
Transmitter frequency:	866 MHz, 868 MHz, 916 MHz
Signal transmission method:	bidirectionally addressed message
Range in free space:	up to 100 m
Minimum control distance:	20 mm

Other data	
Max. number of control.	4
RFSA-6x:	4
Program:	Weekly
Operating temperature:	0 to + 55 °C
Operating position:	vertical
Mounting:	in an installation box
Protection:	IP20
Contamination degree:	2
Cross-section of connecting cables (mm <sup>2</sup> ):	max. 1x 2.5, max. 2x 1.5 / with a hollow max. 1x 2.5
Dimensions frame	
- plastic:	85 x 85 x 46 mm
- metal, glass, wood, granite:	94 x 94 x 46 mm
Weight:	172 g
Related standards:	EN 60669, EN 300 220, EN 301 489 directive R&TTE Directive, Order. No 426/2000 Coll. (Directive 1999/EC)

\*Comes with plastic frame. No installation into multi-frames.

Compatibility				
RF Touch	eLAN-RF	RFSA-6 x	RFSTI-11B	RFATV-1
-	-	✓	✓	✓

- The wireless controller in design LOGUS<sup>90</sup> measures the room temperature by internal sensor, and based on the set temperature, it sends a command for heating / cooling.
- Option of setting a daily/weekly automatic control program.
- The temperature controller can be used in one of two ways:
  - For controlling an additional heat source (heater, oil radiator, radiant panel) with multi-function switching units RFSA-6x, RFUS-61 or RFSC-61.
  - For control of floor heating, when the internal sensor scans the room temperature, and based on the value, controls the heating unit RFSTI-11B, which monitors the critical floor value by external sensor.
- Manual control by buttons on the unit.
- Range of measured temperature 0-55 °C.
- The backlit LCD display displays the current and set temperature, status (ON/OFF), battery status, day of the week, current time, etc.
- The unit power supply is 100-230 V AC.
- Range up to 100 m (in open space), if the signal is insufficient between the controller and unit, use the signal repeater RFRP-20 or protocol component RFIO<sup>2</sup> that support this feature.
- Communication frequency with bidirectional protocol iNELS RF Control.
- Color combination of temperature unit in design of frames LOGUS<sup>90</sup> (plastic, glass, wood, metal, stone).

#### Device description

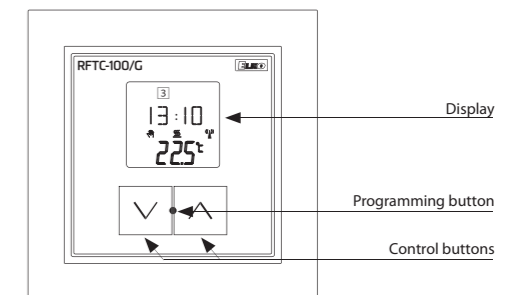

#### Display description

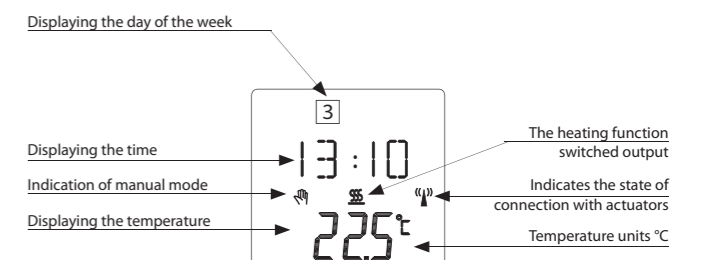

#### Connection

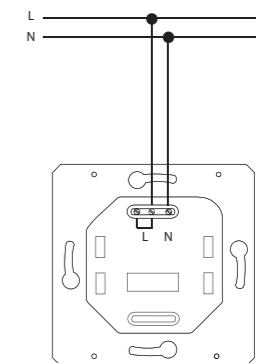



- Monitors areas (e.g. bathrooms, basements, shafts or tanks) to provide flood warning.
- Upon detecting water, the flood detector immediately sends a signal to the switched unit, which further switches on a pump, GSM gate (link to RFGSM-220M) or closes a pipe valve. (Link to valve in accessories).
- Option of connecting an external probe FP-1 (not included in supply) - max. wire length 30 m.
- The programming button on the detector is used to:
  - a) setting the function with switching unit
  - b) ascertaining battery status
  - c) ascertaining signal quality between the unit and detector.
- Battery power supply (1.5 V / CR2477 - included in the supply) with battery life of around 1 year based on frequency of use.
- The detector can be placed anywhere thanks to battery power.
- Range up to 160 m (in open space); if the signal is insufficient between the controller and unit, use the signal repeater RFRP-20 or protocol component RFIO<sup>2</sup> that support this feature.
- Communication frequency with bidirectional protocol iNELS RF Control.

#### Device description

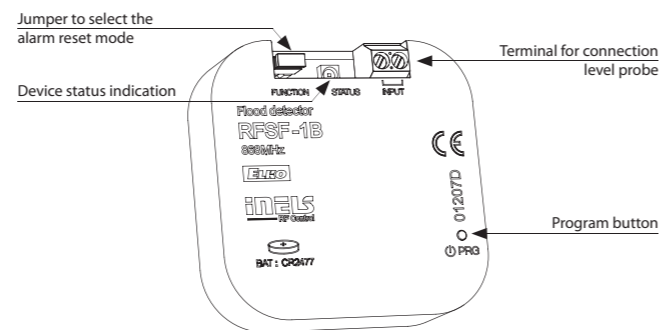

#### Flood probe FP-1

For more information see p. 68.

#### Location of the detector and probe

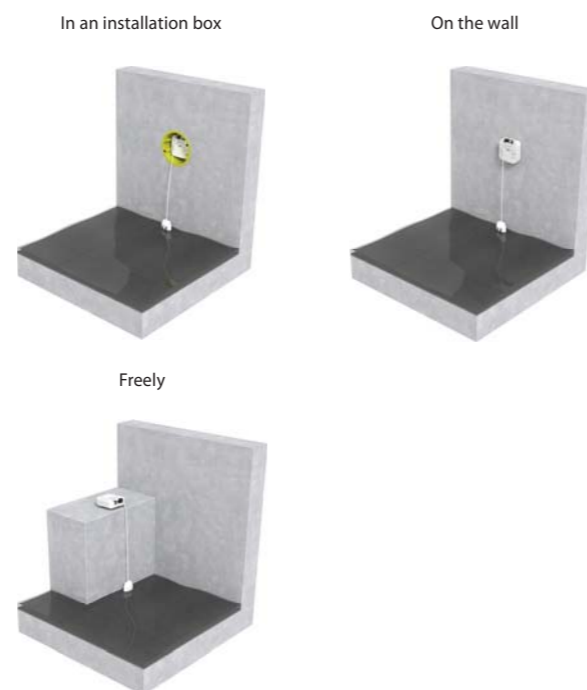

Technical parameters		RFSF-1B
Supply voltage:	1 x 3 V battery CR 2477	
Battery life:	1 year	
Indications / transfer function:	red LED	
Reset after flooding:	JUMPER - Manual / Automatic	
Programming:	with Prog button / based batteries	
Measuring input:	terminal 0.5-1mm <sup>2</sup>	
Voltage measuring input:	3 V	
Resistance measuring input for detecting flooding:	≤20 kΩ	
Resistance measuring input for flushing detection:	≥40kΩ	
Probe cable length:	max. 30 m	
Output		
Frequency:	866 MHz, 868 MHz, 916 MHz	
Signal transmission method:	two-way addressed message	
Range in free space:	up to 160 m	
Other data		
Working temperature:	-10 to +50 °C	
Operating position:	any	
Mounting:	glue / freely	
Protection:	IP30	
Degree of pollution:	2	
Dimensions:	49 x 49 x 13 mm	
Weight:	45 g	
Standards:	EN 60730-1, EN 300 220, EN 301 489 directive R&TTE Directive, Order. No 426/2000 Coll. (Directive 1999/EC)	



Technical parameters		RFTM-1
Power supply:	2x 1.5 battery AAA	
Battery Life:	Appr. 2 years, (depending on the type of sensor, frequency of transmissions and pulses)	
Indication		
Setting mode:	Green LED flashes - active Red LED - flashes during impulse sensor registration	
Communications Test - RF STATUS:	Green LED - communication OK red LED - communication ERR	
Normal operation:	no indication	
Control		
Manual control:	button SET	
Sensor Selection:	rotary potentiometer	
Supported sensors (not included in the package):	LS (LED sensor) MS, WS (magnetic sensor) S0 (Contact, open collector, reed magnetic contacts)	
Output		
Sending RF communication packet:	866 MHz, 868 MHz, 916 MHz	
Range in free space:	up to 100 m	
Other data		
Working temperature:	-20 .. +50 °C *	
Storage temperature:	-30 .. +70°C	
Operating position:	any	
Protection:	IP65	
Cross-section of connecting wires:	max. 0.5 - 1 mm <sup>2</sup>	
Dimension:	72 x 62 x 34 mm	
Weight:	104 g	

\* Pay attention to the operating temperature of batteries.

- The wireless pulse converter detects home energy meters (electric, water, gas) by means of sensors, and sends them to the wireless unit RFBM-2M.
- The energy gateway RFBM-2M acts as an interface between the meter and a smartphone.
- Measured values are displayed in the application iHC-MAIRF/MIIRF, in daily, weekly or monthly overview in graphs.
- The sensor is designed for use on existing meters and even without the impulse output "S0" (The gauge must support scan).
- RFTM-1 transfers consumption from meters using sensors - LS (LED sensor), WS (Magnetic sensor for meter), MS (Magnetic sensor) or by impulse output („S0“).
- For each consumption meter, it is necessary to have one pulse converter RFTM-1.
- The increased IP 65 protection is appropriate for mounting in risers, switchboards and other demanding environments.
- Battery power (1.5 V / 2x AAA - included in package) with average battery life of around 2 years (according to the type of scan, frequency of transmissions and pulses).
- Range up to 100 m (in open space), if the signal between the controller and the user is weak, use the signal repeater RFRP-20 or protocol component RFIO<sup>2</sup> that support this feature.
- Communication frequency with bidirectional protocol iNELS RF Control.

#### Device description

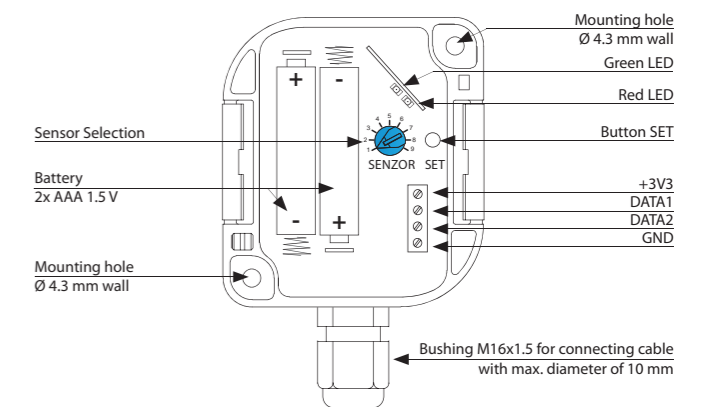

#### Sensors

For more information see p. 70.



- The smoke detector is used for timely warning against a fire started in residential and commercial buildings.
- The detector uses a scanning method by means of an optical chamber having a more sensitive reaction to detection of smoke.
- Use:
  - autonomous fire detector with internal siren
  - in combination with a switching unit for external signaling (light, appliance, siren)
  - by means of the Smart RF box, detection can be displayed on your smart phone, in the form of a notification; alarms are stored in the history, which is visualized in the application iHC.
- The autotest function notifies of a fault with the detector, thereby eliminating its lack of function in case of fire.
- Anti-tamper function: an alarm is triggered if there is an unauthorized interference to detector.
- Power supply: battery 4 x 1.5 V AA, the battery life is around 1 year, ... thanks to the ability to turn off the LED indicator it is possible to extend up to 3 years.
- "Low Battery" Alerts by double LED flashing or on iHC App.
- The detectors are compatible with switching components marked with the iNELS RF Control<sup>2</sup> RFIO<sup>2</sup> communication protocol and the eLAN-RF system components.
- Communication frequency with bidirectional protocol iNELS RF Control<sup>2</sup> (RFIO<sup>2</sup>).

Technical parameters	RFSD-100	RFSD-101
Power supply:	battery 4 x 1.5V AA	
Temperature measurement:	no	yes
Humidity measurement:	no	yes
Light measurement:	no	yes
Drained battery indicator:	yes	
Transmission frequency:	866 MHz, 868 MHz, 916 MHz	
Detection area:	max. 40m <sup>2</sup>	
Optical indication:	red LED	
Assembly height:	max. 7m	
Storage temperature:	-10 .. +50°C	
Protection:	IP20	
Color:	white	
Dimension:	Ø 120 x 36 mm	

## RFWD-100 | Window / Door detector



- The window / door detector is used to detect opening where activation occurs when the magnet and the sensor become separated.
- Use:
  - in combination with the switching unit for automatic light control (cellar, garage, etc.), or switching on a GSM gate
  - by means of the Smart RF box, detection can be displayed on your smart phone in the form of a notification; alarms are stored in the history, which is visualized in the application iHC.
- Anti-tamper function: an alarm is triggered if there is an unauthorized interference to detector.
- Power supply: battery 3 V / CR2032, the battery life is around 1 year, ... thanks to the ability to turn off the LED indicator it is possible to extend up to 3 years.
- "Low Battery" Alerts on Your iHC App.
- The detectors are compatible with switching components marked with the iNELS RF Control<sup>2</sup> RFIO<sup>2</sup> communication protocol and the eLAN-RF system components.
- Communication frequency with bidirectional protocol iNELS RF Control<sup>2</sup> (RFIO<sup>2</sup>).

Technical parameters	RFWD-100
Power supply:	battery 1x 3 V CR2032
Drained battery indicator:	yes
Transmission frequency:	866 MHz, 868 MHz, 916 MHz
Communication protocol:	iNELS RF Control <sup>2</sup> (RFIO <sup>2</sup> )
Working temperature:	-10.. +50°C
Protection:	IP20
Color:	white
Dimension:	25 x 75 x 16 mm / 15 x 75 x 14 mm



Technical parameters	RFMD-100
Power supply:	batterie 2x 1.5 V AA
Battery life:	up to 1 year, according to the number of activations
Drained battery indicator:	yes
Transmission frequency:	866 MHz, 868 MHz, 916 MHz
Communication protocol:	iNELS RF Control <sup>2</sup> (RFIO <sup>2</sup> )
Detection angle:	105°
Detection distance:	max. 12 m
Recommended working height:	max. 2.4 m
Working temperature:	-10.. +50°C
Protection:	IP20
Color:	white
Dimension:	46 x 105 x 43 mm
Weight:	57 g

- The motion detector PIR is used to detect persons moving inside the building interior.
- Use:
  - in combination with a switching unit for automatic control of lighting or triggering an alarm.
  - by means of the Smart RF box, detection can be displayed on your smart phone in the form of a notification; alarms are stored in the history, which is visualized in the application iHC.
- Sensitivity settings of the PIR detector for eliminating unwanted triggering.
- Integrated lighting sensor, thanks to which you can set the detector's reaction time.
- Option of activation / deactivation of the LED indicator on the detector cover.
- Anti-tamper function: an alarm is triggered if there is an unauthorized interference to detector.
- Power supply: battery 2x 1.5 V AA, the battery life is around 1 year.
- "Low Battery" Alerts by double LED flashing or on iHC App.
- The detectors are compatible with switching components marked with the iNELS RF Control<sup>2</sup> RFIO<sup>2</sup> communication protocol and the eLAN-RF system components.
- Communication frequency with bidirectional protocol iNELS RF Control<sup>2</sup> (RFIO<sup>2</sup>).

## Detection field

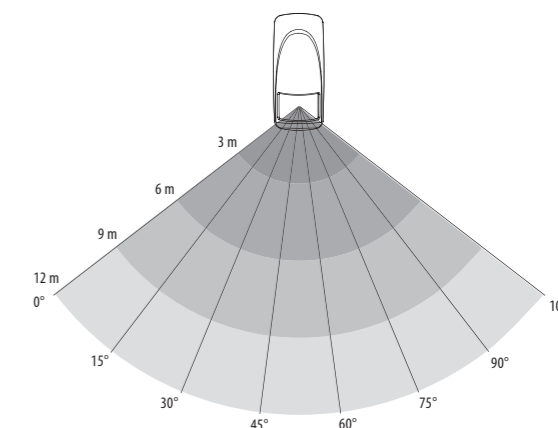

## iNELS Cam | IP camera



- The cloud video camera DCS-933L, capable of scanning both day and night, is a universal monitoring solution for your home or office.
- As opposed to a standard web camera, D-Link is an independent system, which can transmit high quality images without the need for a computer connection.
- It is equipped with a motion detector, and features the function of a Wi-Fi extender/repeater, enabling improvement in range and coverage of your existing home or office wireless network.

## Supported video cameras: Axis, D-link

Technical parameters	iNELS Cam
Power supply:	5 V DC adapter
Resolution:	640 x 480 px
Night light:	yes
Max. cameras in app:	up to 10



# Hotel Room Energy Saving Kit

Costs saving, Increased comfort



**Technical parameters** RFSAI-161B/230V RFSAI-161B/120V RFSAI-161B/24V

Supply voltage:	230 V AC / 50-60 Hz	120 V AC / 60 Hz	12-24 V AC/DC 50-60 Hz
Apparent power:	9 VA / $\cos \varphi = 0.1$	9 VA / $\cos \varphi = 0.1$	-
Dissipated power:	0.7 W		
Supply voltage tolerance:	+10 %; -15 %		

**Output**

Number of contacts:	1x switching (AgSnO <sub>2</sub> )
Rated current:	12 A / AC1
Switching power:	4000 VA / AC1, 384 W / DC
Peak current:	30 A, max. 4 s at 10%
Switching voltage:	250 V $\mu$ AC1 / 24 V DC
Min. switching power DC:	100 mA / 10 V
Insulation voltage between outputs and internal circuits:	reinforced insulation (Cat. III surges by EN 60664-1)
Isolation voltage open contact:	1 kV
Mechanical service life:	3x10 <sup>7</sup>
Electrical service life (AC1):	5x10 <sup>4</sup>
Indication of relay switch:	red LED

**Controlling**

RF command from the detector:	866 MHz, 868 MHz, 916 MHz
Manual control:	button PROG (ON/OFF)
External button:	max. 12 m cable*
Range in open space:	up to 160 m

**Other data**

Open contact voltage external switch:	3 V
Resistor for the management of external switch:	<1 k $\Omega$
Resist. of connection for open contact:	>10 k $\Omega$
Galvanic isolation of input:	no
Operating temperature:	-15 ... + 50 °C
Storage temperature:	-30 ... + 70 °C
Working position:	any
Mounting:	free at lead-in wires
Protection:	IP30
Overvoltage category:	III.
Contamination degree:	2
Terminals:	0.5 - 1 mm <sup>2</sup>
Terminals (CY wire, Cross-section):	2x 0.75 mm <sup>2</sup> , 2x 2.5 mm <sup>2</sup>
Terminal length:	90 mm
Dimensions:	49 x 49 x 21 mm
Weight:	50 g

- Switch component with one output channel which is used in combination with detectors for automatic lighting control.
- Thanks to its unique functionality it is especially suited for hotels.
- Control wireless switch (RFBW-20 or RFBW-40), whose cover can be printed with icons according to your wishes.
- Other possible components in the installation can include a touch unit, RF Touch or smart phone (eLAN-RF, ...).
- MASTER option settings, using this feature to control other components of the installation (prog. Tool RFAF / USB).
- Components support communication with RF detectors.
- The terminals on the component give you the opportunity to connect a wired detector or an existing key installation.
- Switching can be controlled by the wireless twilight switch, measuring the intensity of light in the room.
- It enables connection of the switched load up to 1x 12 A (3000 VA).
- The programming button on the unit is also used for manual control of the output.
- For components it is possible to set the repeater function via the RFAF / USB service device.
- Range up to 160 m (in open space), if the signal is insufficient between the controller and unit, use the signal repeater RFRP-20 or protocol component RFIO<sup>2</sup> that support this feature.
- Communication frequency with bidirectional protocol iNELS RF Control<sup>2</sup> (RFIO<sup>2</sup>).

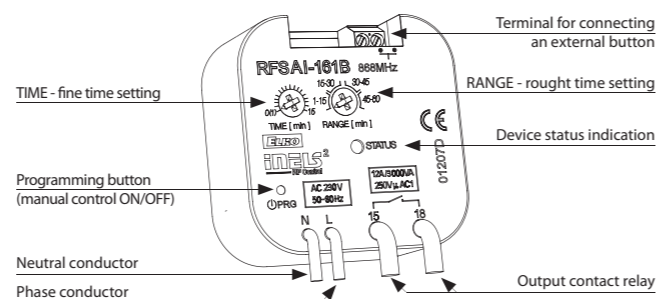
**Device description**

Compatible wireless detectors (Jablotron)  
 Movement: JA-80P, JA-85P, JA-83P  
 Door / Window: JA-81M, JA-82M, JA-83M

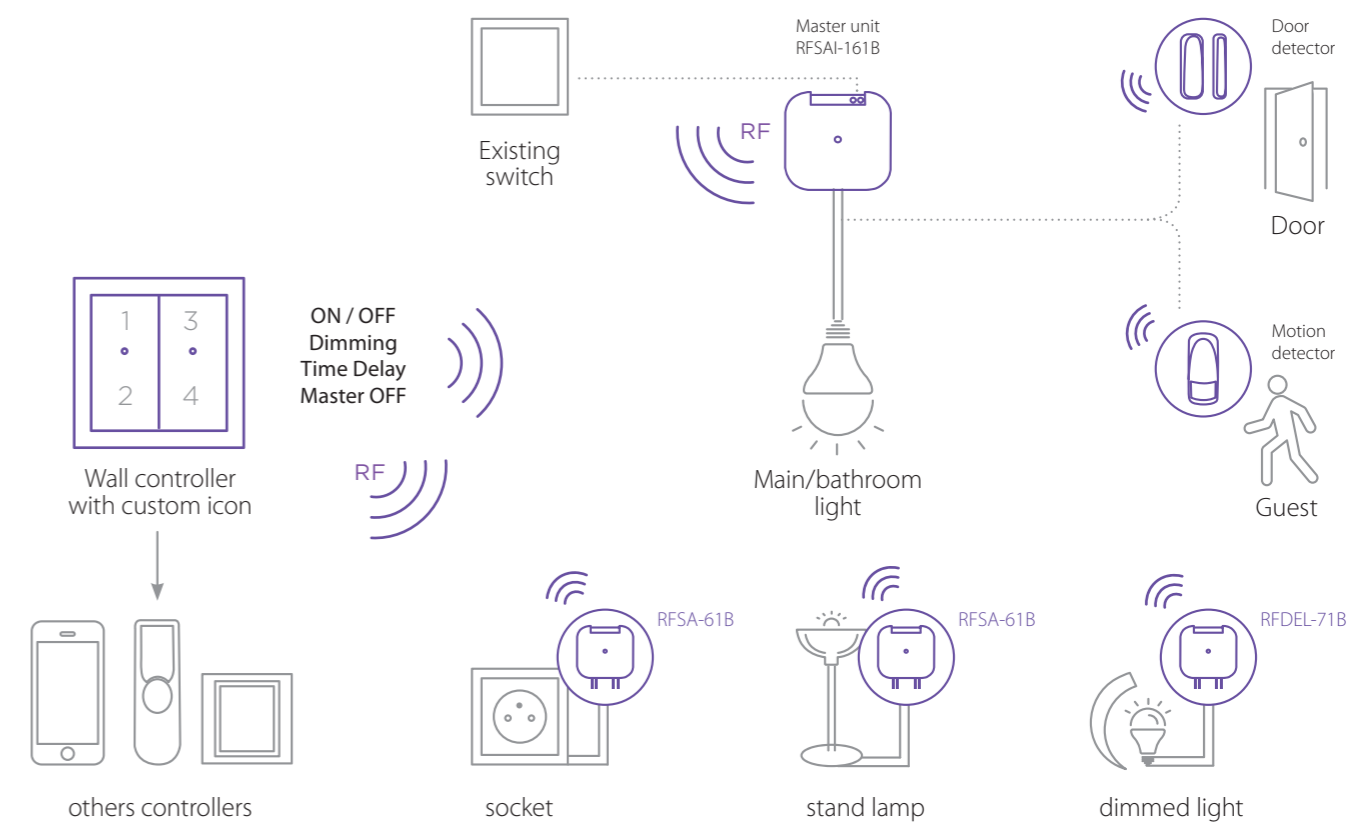
**Connection**

**Function**

When the motion detector (wireless or wired connected via terminals) captures the movement of the guest, the light ON command is sent. (It can be connected via terminals to the existing switch for permanent ON state).

The functionality of door detector is delayed OFF = after the guest (or cleaner) close the door than the timer starts running (which you can set) and the light will turn OFF. If there is movement the command from door detector (delay off) will be cancelled.

If the guest goes to sleep, press number 4 on wireless switch RFBW-40 (which is MASTER OFF button) this is the command for deactivation of the hearing detectors. At the same time the MASTER OFF is sent to all actuators which are controlled from this button.

You are able to control other units like RFDL, RFS (for controlling sockets, lights, curtains) with other channels on wireless switch RFBW-40.

If the guest presses any button on the wireless switch RFBW-40 (or existing push button connected on terminal RFSAI-161B) the automatic regulation of lights will be activated.

\* Control button input is at the supply voltage potential.



Flat design - the depth of the device is only 20 mm!

- The wireless controller RFTC-150/G in design LOGUS<sup>90</sup> measures the room temperature by internal sensor. On the basis of a set program it sends commands to the switching component RFSA-166M Switching fan coil.
- It is possible to set automatic or manual mode.
- Range of measured temperature 0 ... 55 °C.
- The backlit LCD display displays the current and set temperature, status (ON/OFF), battery status, day of the week, current time, etc.
- Battery power (1.5 V / 2x AAA - included in supply) with battery life of around 1 year based on frequency of use.
- The flat rear side of the device enables its placement anywhere in the room.
- Color combination of temperature unit in design of frames LOGUS<sup>90</sup> (plastic, glass, wood, metal, stone).
- Components support communication with RF detectors.
- Range up to 100 m (in open space), if the signal is insufficient between the controller and unit, use the signal repeater RFRP-20 or protocol component RFIO<sup>2</sup> that support this feature.
- Communication frequency with bidirectional protocol iNELS RF Control.

#### Connection

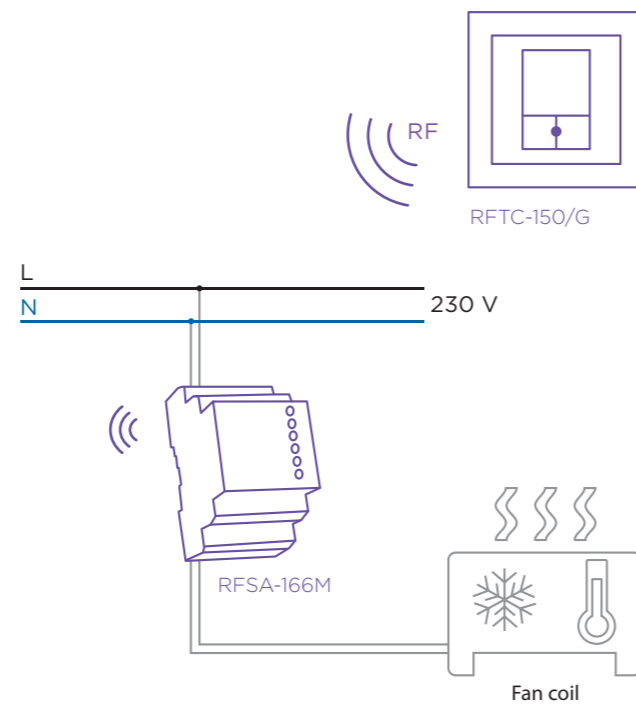

Technical parameters	RFTC-150/G
Supply voltage:	2x 1.5 V AAA battery
Battery life:	up to 1 year
Temperature offset:	2 buttons V / ^
Offset:	± 5 °C
Display:	LCD, characters
Backlighting:	YES / active - blue
Transmission indication / function:	symbols
Temperature measurement input:	1x internal sensor
Temp. measurement range and accuracy:	0 .. + 55 °C ; 0.3 °C of the range
Transmitter frequency:	866 MHz, 868 MHz, 916 MHz
Signal transmission method:	bidirectionally addressed message
Range in free space:	up to 100 m
Minimum control distance:	20 mm
<b>Other data</b>	
Max. number of controlling actuators RFSA-166M:	1
Program:	Weekly
Operating temperature:	0 up to + 55 °C
Operating position:	on the wall
Mounting:	by gluing / screwing
Protection:	IP20
Contamination degree:	2
Dimensions	
- plastic:	85 x 85 x 20 mm
- metal, glass, wood, granite:	94 x 94 x 20 mm
Weight:	66 g (without batteries)
Related standards:	EN 60669, EN 300 220, EN 301 489 directive R&TTE Directive, Order. No 426/2000 Coll. (Directive 1999/EC)



EXTERNAL ANTENNA AN-E

Technical parameters	RFSA-166M/230 V
Supply voltage:	110-230 V AC / 50-60 Hz
Apparent input:	min. 2 VA / max. 5 VA
Dissipated power:	min. 0.5W / max. 2.5W
Supply voltage tolerance:	+10% / -25 %
<b>Output</b>	
Number of contacts:	3x changeover (AgSnO <sub>2</sub> ); 3x switching (AgSnO <sub>2</sub> )
Rated current:	8 A / AC1
Switching power:	2000 VA / AC1
Peak current:	10 A / <3 s
Switching voltage:	250 V AC1
Max. DC switching power:	500 mW
Mechanical service life:	1x10 <sup>7</sup>
Electrical service life (AC1):	1x10 <sup>5</sup>
<b>Control</b>	
RF, by command from transmitter:	866 MHz, 868 MHz, 916 MHz
Manual control:	MAN button
Range in free space:	up to 200 m
Output for antenna:	SMA connector*
<b>Other data</b>	
Operating temperature:	-15 °C to + 50 °C
Operating position:	any
Mounting:	DIN rail EN 60715
Protection:	IP20 from the front panel
Overvoltage category:	III.
Contamination degree:	2
Connecting conductor cross-section (mm <sup>2</sup> ):	max. 1x 2.5, max. 2x 1.5 / with a hollow max. 1x 2.5
Dimensions:	90 x 52 x 65 mm
Weight:	264 g
Related standards:	EN 60669, EN 300 220, EN 301 489 R&TTE Directive, Order. No 426/2000 Coll. (Directive 1999/EC)

\* Max Tightening Torque for antenna connector is 0.56 Nm.

- Thanks to the 6-channel design of the switching component it can control the heating / cooling mode and with 3 speeds, the RE6 output channel can be used to control appliances, sockets or lights.
- The RFSA-166M wireless switching component can be combined with the RFTC-150/G.
- Up to 25 detectors RFRP-100 can be assigned to the switching component.
- The RFRP-100 can be assigned to the RFSA-166M using the PRG button.
- Output Channel RE6:
  - Up to 25 channels can be controlled (1 channel represents one button on the controller).
  - can be combined with detectors, controllers or system components of iNELS RF Control.
  - Function: button, pulse relay and delayed start or return time functions with 2s-60min time setting.
  - Memory status is retained in the event of a power failure.
  - The PRG6 programming button on the component also serves as manual control of the RE6 output.
- The package includes an internal antenna AN-I, in case of locating the element in a metal switchboard, you can use the external antenna AN-E for better signal reception.
- Range up to 100 m (in open space), if the signal is insufficient, use the signal repeater RFRP-20 or protocol component RFIO<sup>2</sup> that support this feature.
- For components it is possible to set the repeater function via the RFAF/USB service device.
- Communication frequency with bidirectional protocol iNELS RF Control<sup>2</sup> (RFIO<sup>2</sup>).

#### Connection







- Temperature component with one output channel serves as protection against overheating of the room, where the influence of temperature can cause damage to furniture and appliances.
- It is particularly suitable for rooms with a tropical climate.
- The component measures temperature in the range of 5...35 °C external sensor and on the basis of the set (critical) temperature fan coil switches, air conditioning.
- The BOX design lets you mount it right in an installation box, a ceiling or controlled appliance cover.
- It enables connection of the switched load up to 12 A (3000 VA).
- Components support communication with RF detectors.
- Range up to 160 m (in open space), if the signal is insufficient between the controller and unit, use the signal repeater RFRP-20 or protocol component RFIO<sup>2</sup> that support this feature.
- For components it is possible to set the repeater function via the RFAF / USB service device.
- Communication frequency with bidirectional protocol iNELS RF Control<sup>2</sup> (RFIO<sup>2</sup>).
- External sensor TC (0 ..+70 °C) or TZ (-40 ..+125 °C) for length of 3 m, 6 m, 12 m.

#### Device description

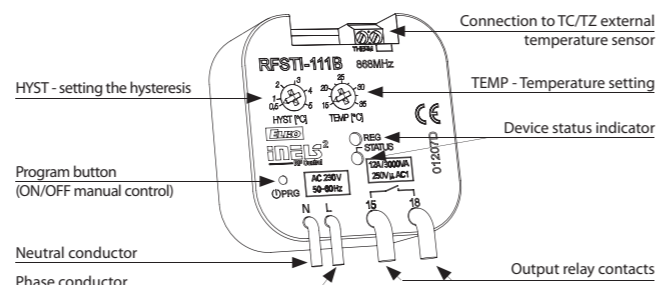

#### Function

The external sensor senses the temperature of the room, turns the air conditioner on and off according to the set temperature. Responds to commands from the detector - when you open the window, turn off air conditioning.

#### Connection

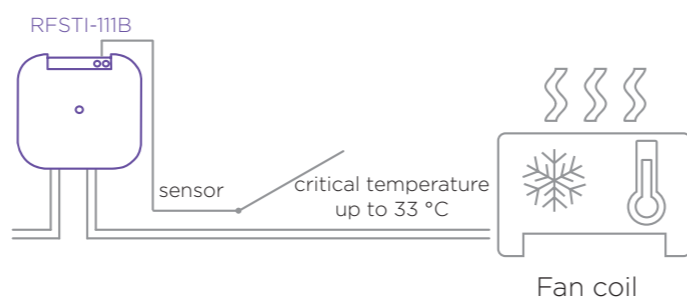

Technical parameters	RFSTI-111B/230V	RFSTI-111B/120V	RFSTI-111B/24V
Supply voltage:	230 V AC / 50-60 Hz	120 V AC / 60 Hz	12-24 V AC / DC 50-60 Hz
Apparent input:	9 VA / cos φ = 0.1	9 VA / cos φ = 0.1	-
Dissipated power:	0.7 W		
Supply voltage tolerance:	+10 %; -15 %		
Temperature measurement input:	1x external TZ/TC temperature sensor input *		
Temp. measurement range and accuracy:	-20 to +50 °C; 0.5 °C of the range		
<b>Output</b>			
Number of contacts:	1x switching (AgSnO <sub>2</sub> )		
Rated current:	12 A / AC1		
Switching power:	3000 VA / AC1, 384 W / DC		
Peak current:	30 A / max. 4s at 10%		
Switching voltage:	250 V μ AC1 / 24 V DC		
Min. switching power:	100 mA / 10 V		
Insulation voltage between relay outputs and internal circuits:	reinforced Insulation (Cat. III surges by EN 60664-1)		
Isolates. voltage open relay contact:	1 kV		
Mechanical service life:	3x10 <sup>7</sup>		
Electrical service life (AC1):	5x10 <sup>4</sup>		
<b>Control</b>			
Transmitter frequency:	866 MHz, 868 MHz, 916 MHz		
Range:	up to 160 m		
<b>Other data</b>			
Operating temperature:	-15 ... + 50 °C		
Storage temperature:	-30 ... + 70 °C		
Status indication:	red LED		
Indication regulation:	green LED		
Operating position:	any		
Mounting:	free at lead-in wires		
Protection:	IP30		
Overvoltage category:	III.		
Contamination degree:	2		
Outlets (CY wire, cross-section, length):	2 x 0.75 mm <sup>2</sup> , 2 x 2.5 mm <sup>2</sup> , 90 mm		
Dimensions:	49 x 49 x 21 mm		
Weight:	50 g		

\* Temperature sensor input is at the supply voltage potential.



Technical parameters	RFPCR-31/G
Supply voltage:	110 - 230 V AC / 50 - 60 Hz
Dissipated power:	max. 2.5 W
Apparent input:	max. 5 VA
<b>Buttons</b>	
Number of control buttons:	2
<b>RFID readers</b>	
Supported frequencies:	13.56 MHz
Card Type:	MIFARE Ultralight, DESFire 2K (EV1), DESFire 4K (EV1)
<b>Outputs</b>	
Output:	1x changeover 8A / AgSnO <sub>2</sub>
Indication:	two-color LED (red, green)
Acoustic output:	piezo-changer
Switching voltage:	230V AC/ 30V DC
Switching output:	2000 VA/AC1; 240 W/DC
Peak current:	20 A / <3s
Insulation voltage between relay outputs and internal circuits:	3.75 kV, SELV according to EN 60950
Minimal switched current:	10 mA / 10 V
Switching frequency without load:	300 min <sup>-1</sup>
Switching frequency with rated load:	15 min <sup>-1</sup>
Mechanical life:	1x 10 <sup>7</sup>
Electrical life AC1:	1x 10 <sup>5</sup>
<b>Control</b>	
Transmitter frequency:	866 MHz, 868 MHz, 916 MHz
Range:	up to 160 m
<b>Connection</b>	
Network:	max. 2.5 mm <sup>2</sup> /1.5 mm <sup>2</sup> with sleeve
<b>Operating conditions</b>	
Operating temperature:	-20 to +55 °C
Storing temperature:	-30 to +70 °C
Protection degree:	IP20
Overvoltage category:	II.
Pollution degree:	2
Operation position:	any
Installation:	into installation box
<b>Dimensions</b>	
- plastic:	85.6 x 85.6 x 42 mm
- metal, glass, wood, granite:	94 x 94 x 36 mm
Weight:	68 g (without frame)

- RFPCR-31/G is a wall-mounted card reader that is designed for read contactless media (smart cards, key chains, etc.), which are used for controlling access to buildings or their parts.
- The reader sends a wireless command to switch, signaling, bell, etc. This makes it suitable for reconstruction, where the main benefit is the installation speed.
- RFPCR-31/G reader can be used to control the security system (locking / unlocking) access system (opening doors, gates, etc.) or appliances (based on assigned rights).
- RFPCR-31/G supports RFID media with the carrier frequency of 13.56 MHz. Supported card types MIFARE Ultralight, DESFire 2K (EV1), DESFire 4K (EV1).
- RFPCR-31/G is also equipped with 8A relay output with changeover contact AgSnO<sub>2</sub>, by which controlled devices can be switched directly.
- Range up to 160 m (in open space), if the signal is insufficient between the card reader and unit, use the signal repeater RFRP-20 or protocol component RFIO<sup>2</sup> that support this feature.
- Communication frequency with bidirectional protocol iNELS RF Control<sup>2</sup> (RFIO<sup>2</sup>).
- Wall card reader RFPCR-31/G is compatible with both types of frames LOGUS<sup>90</sup> (85.6 x 85.6 or 94 x 94 mm), therefore you can combine them with double and triple frames and classic products of the series.

#### Connection

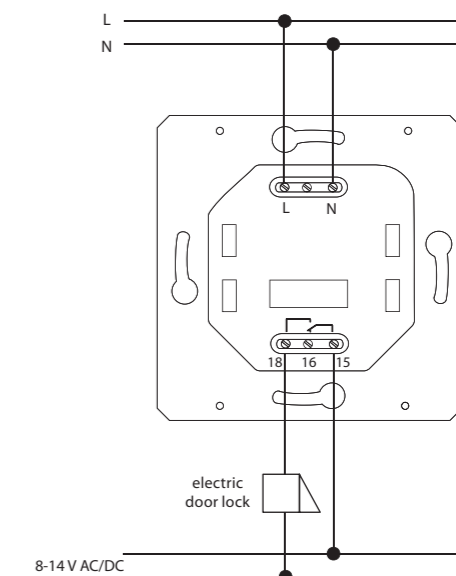

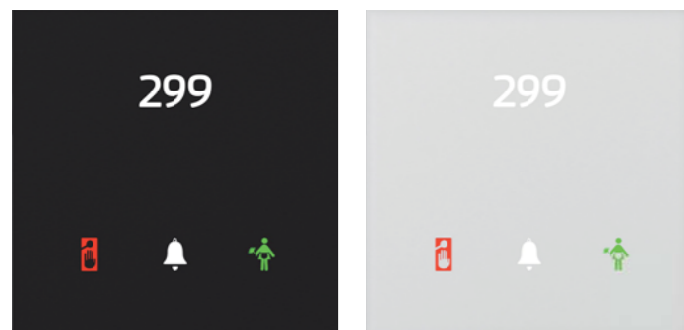

- Multifunctional RFID card reader RFGCR-31 is part of a comprehensive range of glass control units and can be advantageously used in all projects, e.g. guest room management system.
- The reader sends a wireless command to switch, signaling, bell, etc. This makes it suitable for reconstruction, where the main benefit is the installation speed.
- RFGCR-31 card reader is designed for reading smart cards, which are intended to enter the hotel room or any other part of the building.
- RFGCR-31 supports RFID media with a carrier frequency of 13.56 MHz. Supported card types MIFARE Ultralight, DESFire 2K (EV1), DESFire 4K (EV1).
- The RFGCR-31 is a design component of the system and is available in elegant black (RFGCR-31/B) and white (RFGCR-31/W) variants.
- Input card reader is the first device of guest room management system, with which the hotel guest comes into contact first and therefore was designed with an emphasis on representative design.
- Printing is possible to customize to the investor requirements. The room number as well as the logo of the hotel can be also printed on each component.
- The controller is also equipped with touch button with function of bell and with two icons to indicate the status of guest requests, e.g. "Do Not Disturb" and "Make Up Room".
- Individual symbols can be illuminated in one of seven colours - red, green, blue, yellow, pink, turquoise and white.
- Reader RFGCR-31 is equipped with an 8A relay output with AgSnO<sub>2</sub> contact for door lock control.
- Reader RFGCR-31 is equipped with a sensor for ambient light intensity. Based on information from the sensor it can e.g. switch the lighting circuits in the corridor.
- Range up to 160 m (in open space), if the signal is insufficient between the card reader and unit, use the signal repeater RFRP-20 or protocol component RFIO<sup>2</sup> that support this feature.
- Communication frequency with bidirectional protocol iNELS RF Control<sup>2</sup> (RFIO<sup>2</sup>).
- All versions are in the size of the module (94x94 mm) from the line of luxury switches and sockets LOGUS<sup>90</sup> and are therefore fully in line with the design of frames for the sockets of this series, where you can just as for the controllers choose white and black glass frames.
- RFGCR-31 are designed for mounting into an installation box.

#### Connection

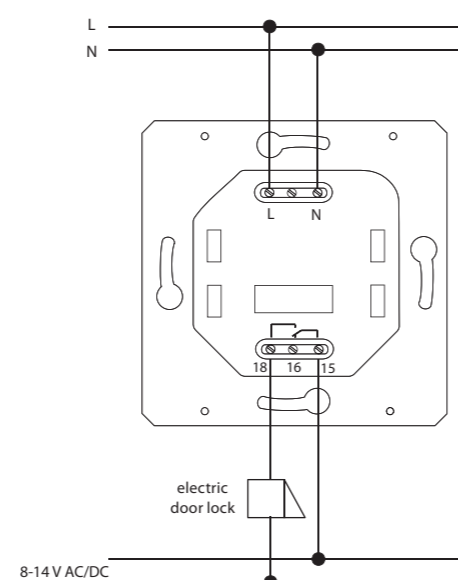

Technical parameters		RFGCR-31
Supply voltage:	110 - 230 V AC / 50 - 60 Hz	
Dissipated power:	max. 2.5 W	
Apparent input:	max. 5 VA	
<b>Input</b>		
Illuminance sensor:	1 ... 100 000 Lx	
<b>Buttons</b>		
Number of control buttons:	3	
Type:	Capacitive	
Indication:	Coloured illuminated symbol	
<b>RFID readers</b>		
Supported frequencies:	13.56 MHz	
Card Type:	MIFARE Ultralight, DESFire 2K (EV1), DESFire 4K (EV1)	
<b>Outputs</b>		
Signalling:	Do Not Disturb, Make Up Room	
Output:	1x changeover 8 A / AgSnO <sub>2</sub>	
Acoustic output:	piezo-changer	
Tactile output:	Vibration motor	
Switching voltage:	230V AC/ 30V DC	
Switching output:	2000 VA/AC1; 240 W/DC	
Peak current:	20 A/<3s	
Insulation voltage between relay outputs and internal circuits:	3.75 kV, SELV according to EN 60950	
Minimal switched current:	10 mA / 10 V	
Switching frequency without load:	300 min <sup>-1</sup>	
Switching frequency with rated load:	10 min <sup>-1</sup>	
Mechanical life:	1x 10 <sup>7</sup>	
Electrical life AC1:	1x 10 <sup>5</sup>	
<b>Control</b>		
Transmitter frequency:	866 MHz, 868 MHz, 916 MHz	
Range:	up to 160 m	
<b>Connection</b>		
Network:	max. 2.5 mm <sup>2</sup> / 1.5 mm <sup>2</sup> with sleeve	
<b>Operating conditions</b>		
Relative humidity:	max. 80 %	
Operating temperature:	-15 .. +55 °C	
Storing temperature:	-30 .. +70 °C	
Protection degree:	IP20	
Overvoltage category:	II.	
Pollution degree:	2	
Operation position:	any	
Installation:	into installation box	
Dimensions:	94 x 94 x 36 mm	
Weight:	161 g	

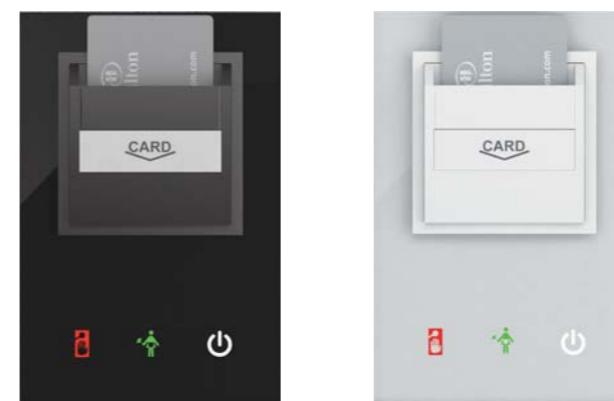

Technical parameters		RFGCH-31
Supply voltage:	110 - 230 V AC / 50 - 60 Hz	
Dissipated power:	max. 2.5 W	
Apparent input:	max. 5 VA	
<b>Input</b>		
Illuminance sensor:	1 ... 100 000 Lx	
<b>Buttons</b>		
Number of control buttons:	3	
Type:	Capacitive	
Indication:	Coloured illuminated symbol	
<b>RFID readers</b>		
Supported frequencies:	13.56 MHz	
Card Type:	MIFARE Ultralight, DESFire 2K (EV1), DESFire 4K (EV1)	
<b>Outputs</b>		
Signalling:	Do Not Disturb, Make Up Room	
Output:	1x switching 10A / AgSnO <sub>2</sub>	
Acoustic output:	piezo-changer	
Tactile output:	Vibration motor	
Switching voltage:	230V AC/ 30V DC	
Switching output:	2500 VA / AC1; 300 W/DC	
Insulation voltage between relay outputs and internal circuits:	3.75 kV, SELV dle EN 60950	
Minimal switched current:	10 mA / 10 V	
Switching frequency without load:	300 min <sup>-1</sup>	
Switching frequency with rated load:	10 min <sup>-1</sup>	
Mechanical life:	1x 10 <sup>7</sup>	
Electrical life AC1:	1x 10 <sup>5</sup>	
<b>Control</b>		
Transmitter frequency:	866 MHz, 868 MHz, 916 MHz	
Range:	up to 160 m	
<b>Connection</b>		
Network:	max. 2.5 mm <sup>2</sup> /1.5 mm <sup>2</sup> with sleeve	
<b>Operating conditions</b>		
Relative humidity:	max. 80 %	
Operating temperature:	-15 .. +55 °C	
Storing temperature:	-30 .. +70 °C	
Protection degree:	IP20	
Overvoltage category:	II.	
Pollution degree:	2	
Operation position:	any	
Installation:	into installation box	
Dimensions:	142 x 94 x 36 mm	
Weight:	210 g	

- Glass card holder RFGCH-31 is part of a comprehensive range of glass control units for guest room management system.
- The smart card holder sends a wireless command to switch on the alarm, bell, etc. This makes it suitable for reconstruction, where the main benefit is the installation speed.
- RFGCH-31 serves for inserting the RFID card into the holder, whereby the system acquires the information about whether the hotel guest is present in the room. With this information it is possible to ensure for example Exit function with relation to energy savings in the absence of a guest in the room.
- Glass card holder is a design component of the system and is available in elegant black (RFGCH-31/B) and white (RFGCH-31/W) version.
- The RFGCH-31 component is equipped with an RFID reader and is thus able to identify the specific hotel card inserted. Power saving function in the absence of a guest cannot be bypassed by simply inserting business cards into the holder.
- RFGCH-31 supports RFID media with a carrier frequency of 13.56 MHz. Supported card types are MIFARE Ultralight, DESFire 2K (EV1), DESFire 4K (EV1).
- The unit is also equipped with three touch buttons that can be used for example to set room status "Do Not Disturb" or "Make Up Room".
- Card holder printing is possible to customize to the investor requirements. The logo of the hotel can be shown for example. Likewise, it is also possible to adapt the card printing.
- The RFGCH-31 unit is equipped with an 10A relay output and an Ag-SnO<sub>2</sub> contact, which switches the phase conductor.
- Individual symbols can be illuminated in one of seven colours - red, green, blue, yellow, pink, turquoise and white.
- Range up to 160 m (in open space), if the signal is insufficient between the holder and unit, use the signal repeater RFRP-20 or protocol component RFIO<sup>2</sup> that support this feature.
- Communication frequency with bidirectional protocol iNELS RF Control<sup>2</sup> (RFIO<sup>2</sup>).
- RFGCH-31 are designed for mounting into an installation box.

#### Connection

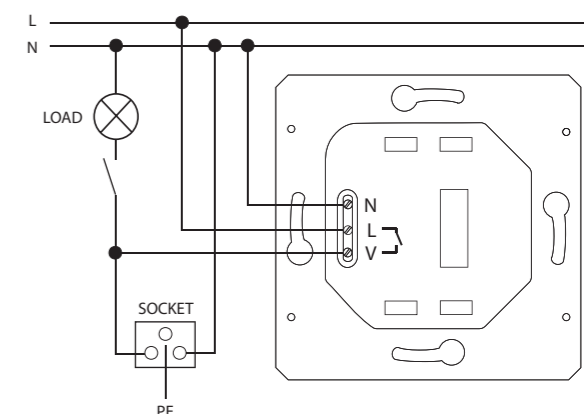

## TELVA 230V, TELVA 24V | Termodrive



- The thermo-regulation drive TELVA is used to control underfloor and radiator hot-water heating.
- It is known for its quiet operation. It has a built-in valve position indicator.
- By mounting using the VA valve adapter, the thermo-regulation drive TELVA is applicable for a wide range of thermostatic valves available on the market.
- Design:
  - without voltage open (NO)
  - without voltage closed (NC)
- Type of use:
 

Underfloor heating - wireless controller RFTC-50/G measures the room temperature, and based on the set program, sends a command to the switching unit RFSA-66M to open / close the thermo-regulation drive TELVA at the distribution.rozdělovači.

EAN code  
TELVA 230V, NC: 8595188166010  
TELVA 230V, NO: 8595188166027  
TELVA 24V, NC: 8595188166034  
TELVA 24V, NO: 8595188166041

Technical parameters	TELVA 230V	TELVA 24V
Operating voltage:	230 V, 50 / 60 Hz	24 V, 50 / 60 Hz
Switching current max:	300 mA for max. 2 min	250 mA for max. 2 min
Operating current:	8 mA	75 mA
Closing / opening time:	cca 3 min.	cca 3 min.
Power input:	1.8 W	1.8 W
Protection:	IP54/II	IP54/II
Settings:	4 mm	4 mm
Stopping force:	100 N ± 5 %	100 N ± 5 %
Cable length:	1 m	1 m
Connecting wire:	2 x 0.75 mm <sup>2</sup>	2 x 0.75 mm <sup>2</sup>
Media temperature:	0 .. +100 °C	0 .. +100 °C
Color:	white RAL 9003	white RAL 9003
Dimensions h/w/d:	55+5 x 44 x 61 mm	55+5 x 44 x 61 mm

## AN-I | Internal antenna



- into plastic switchboard
- rod angle, without cable
- sensitivity 1 dB
- the internal antenna is included in the standard package

EAN code  
Internal antenna AN-I: 8595188161862

## AN-E | External antenna



- for mounting into metal switchboard
- cable length 3 m
- sensitivity 5 dB
- the external antenna AN-E is supplied on request only

EAN code  
External antenna AN-E: 8595188190121

## FP-1 | Flood probe



Technical parameters	FP-1
Working temperature:	-10 to +40 °C
Mounting:	glue
Length of cable:	2 m
Dimensions:	60 x 30 x 8 mm
Related standards:	EN 50130-4, EN 55022

EAN code  
FP-1: 8595188147064

## TC, TZ | Thermo sensors



EAN code  
TC-0: 8595188110075 TZ-0: 8595188140591  
TC-3: 8595188110617 TZ-3: 8595188110600  
TC-6: 8595188110082 TZ-6: 8595188110594  
TC-12: 8595188110099 TZ-12: 8595188110587

Technical parameters	TC	TZ
Range:	0 °C to +70 °C	-40°C to +125°C
Scanning element:	NTC 12K 5 %	NTC 12K 5 %
In air/ in water:	(τ65) 92 s / 23 s	(τ65) 62 s / 8 s
In air/ in water:	(τ95) 306 s / 56 s	(τ95) 216 s / 23 s
Cable material:	High temperature PVC	Silicone
Terminal material:	High temperature PVC	Nickel plated copper
Protection degree:	IP67	IP67
Insulation:	-	-

## Types of temperature sensors:

	TC-0	TZ-0
- length:	100 mm	110 mm
- weight:	5 g	4.5 g
- length:	3 m	3 m
- weight:	108 g	106 g
- length:	6 m	6 m
- weight:	213 g	216 g
- length:	12 m	12 m
- weight:	466 g	418 g

τ65 (95): time, which sensor needs to heat up on 65 (95) % of ambient temperature of environment, in which is located.

- Thermister temperature sensors are made of Negative Temperature Coefficient (NTC) embedded in a PVC or metal sleeve with a thermally-conductive sealer.
- **Sensor TC**
  - lead-in cable to sensor TC is made of wire CYSY 2D x 0.5 mm/ 0.02".
- **Sensor TZ**
  - cable VO3SS-F 2D x 0.5 mm /0.02" with silicone insulation for use in high temperature applications.
  - silicone insulation for use in high temperature applications.
- Temperature sensors can be connected directly to the terminal block
- cable lengths can not be changed, connected or modified.

## Resistive values of sensors in dependance on temperature

Temperature (°C)	Sensor NTC (kΩ)
20	14.7
30	9.8
40	6.6
50	4.6
60	3.2
70	2.3

Tolerance of sensor NTC 12 kΩ is ± 5% by 25 °C / 77°F.

## Diagramm of sensor warm up via air

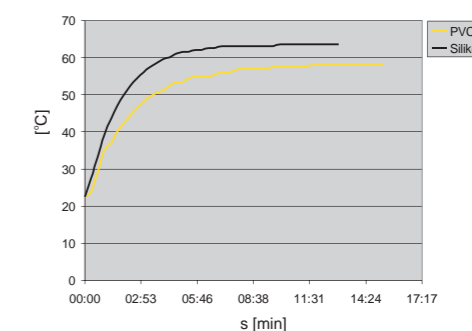

PVC - reaction to water temperature from 22.5 °C to 58°C.  
Silicone - reaction to water temperature from 22.5°C to 63.5°C.

## Sensor photo



## CT50 | Current transformer



EAN code  
CT50: 8595188155908

- Current Transformer - CT50 has open clips, which can be opened and closed. This design allows a current transformer to be placed on the existing measuring circuit wire, usually at the main flow of the meter.

Technical parameters	CT50
Current:	50 A
Output:	50 A / 16.66 mA
Conversion ratio:	3000:1
Accuracy:	1 %
Dielectric strength, Ferrite cores / secondary winding:	2000 V AC / 1 min
Frequency:	50 - 60 Hz
<b>Other data</b>	
Operating temperature:	-15 .. 60 °C
Storing temperature:	-30 .. 90 °C
Flammability:	UL 94 - V <sub>0</sub>
Max. diameter through the conductors:	16 mm
Dimension (w x h x d):	31 x 46 x 32 mm
Weight:	86 g

## LS, MS, WS | Sensors



EAN code  
LS: 8595188155762  
MS: 8595188155779  
WS: 8595188157940

Technical parameters	LS	MS	WS
Working temperature:	-20 .. +50°C		
Cross-section of connecting wires:	max. 3.5 mm		
Wire length:	1.5 m*		
Protection:	IP20		

\* the standard supplied length of 1.5m can be custom ordered in an extended version of up to 5 m.

**LS (LED sensor):**

- The LED sensor scans LED impulses on the meter, which indicates consumption by flashing.
- The LED sensor is particularly suitable for power meters that support LED pulse sensing (the LED on the meter is marked "imp").
- The sensor's scanner is affixed with glue above the LED diode of the meter signaling indication of consumption.
- The sensor is connected to the internal terminal of the RFTM-1 converter.

**MS (Magnetic sensor):**

- The magnetic sensor scans movement of the numeral, upon which a permanent magnet is placed.
- The MS sensor is particularly suitable for gas meters that support magnetic sensing.
- The sensing sensor is glued over the last number of the face dial measured.
- The sensor is connected to the internal terminal of the RFTM-1 converter.

**WS (magnetic sensor water meter):**

- A magnetic sensor that detects the pulse that is created by each rotation of the magnet placed on the unit dial meter.
- The WS sensor is especially suitable for water meters that support magnetic sensing.
- The sensing sensor is glued over the circular unit face of the gauge (the scanning dial is different from the other indicators, e.g. the white arrow wheel).
- The sensor is connected to the internal terminal of the RFTM-1 converter.



- The RFAF / USB Service Key (in conjunction with the RF\_analyzer) is designed for iNELS RF Control system partners and serves for:
  - Setting the repeater (signal amplifier) through the iNELS RF Control elements labeled as RFIO<sup>2</sup>. This option allows you to communicate over longer distances (in the order of 50 m) via existing iNELS RF Control elements in the installation (eliminating the use of the RFRP-20 repeater).
  - upgrade of firmware in the iNELS RF Control elements (labeled RFIO<sup>2</sup>), in the case of new firmware versions that improve the functionality of the elements on which we are constantly working.
  - The RF Network Analyzer will reliably analyze the communication between the controller (where you plan to place it) and the component in the installation. Indicates signal strength / quatty as well as possible frequencies that can interfere with communication.
  - sw RF analyzer can be found at [inels.com/partners](http://inels.com/partners) in section SW / FW RF Control

Technické parametry	RFAF/USB
Power:	max. 1W
Interface:	USB 1.1 and higher, plug. „A“
Range:	100 m
Min. distance of RF Touch-actuator:	1m
Frequency:	866 MHz, 868 MHz, 916 MHz
Power supply indication:	green LED
RF communication indication:	red LED
<b>Operating conditions</b>	
Operating temperature:	0 to +55°C
Storage temperature:	- 20 to +70°C
Protection:	IP30
Contamination degree:	2
Work space:	any
Installation:	any
Dimensions:	22 x 85 x 15 mm
Weight:	20 g
Related standards:	EN 60950-1



Single function - RFSA-11B

Function button ON/OFF



The output contact closes by pressing one button position, and opens by pressing the other button position.

Multi function - RFSA-61B, RFSA-62B, RFSA-61M, RFSA-66M, RFSAI-61B, RFSAI-62B, RFSC-61, RFUS-61

Function 1 - button



The output contact will be closed by pressing the button and opened by releasing the button.

Function 2 - switch on



The output contact will be closed by pressing the button.

Function 3 - switch off



The output contact will be opened by pressing the button.

Function 4 - impulse relay

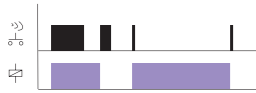

The output contact will be switched to the opposite position by each press of the button. If the contact was closed, it will be opened and vice versa.

Function 5 - delayed off

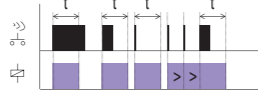

The output contact will be closed by pressing the button and opened after the set time interval has elapsed.  
t = 2 s ... 60 min.

Function 6 - delayed on

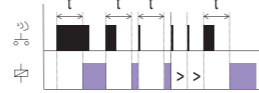

The output contact will be opened by pressing the button and closed after the set time interval has elapsed.  
t = 2 s ... 60 min.

Loadability products

RFJA-12B; RFSA-62B; RFSAI-62B; RFSA-66M; RFSTI-11/G; RFGSM-220M

Load type	cos φ ≥ 0.95	M	M	AC5a without compensation	AC5a with compensation	HAL 230V			
Contact material AgSnO <sub>2</sub> , Contact 8 A	AC1 250 V / 8 A	AC2 250 V / 5 A	AC3 250 V / 4 A	x	x	AC5b 250 W	AC6a 250 V / 4 A	AC7b 250 V / 1 A	AC12 250 V / 1 A
Load type									
Contact material AgSnO <sub>2</sub> , Contact 8 A	AC13 x	AC14 250 V / 4 A	AC15 250 V / 3 A	DC1 30 V / 8 A	DC3 24 V / 3 A	DC5 30 V / 2 A	DC12 30 V / 8 A	DC13 30 V / 2 A	DC14 x

RFUS-61

Load type	cos φ ≥ 0.95	M	M	AC5a without compensation	AC5a with compensation	HAL 230V			
Contact material AgSnO <sub>2</sub> , Contact 14 A	AC1 250 V / 12 A	AC2 250 V / 5 A	AC3 250 V / 3 A	230 V / 3 A (690 VA)	230 V / 3 A (690 VA) up to max input C=14uF	AC5b 1000 W	AC6a x	AC7b 250 V / 3 A	AC12 x
Load type									
Contact material AgSnO <sub>2</sub> , Contact 14 A	AC13 x	AC14 250 V / 6 A	AC15 250 V / 6 A	DC1 24 V / 10 A	DC3 24 V / 3 A	DC5 24 V / 2 A	DC12 24 V / 6 A	DC13 24 V / 2 A	DC14 x

RFSA-11B; RFSA-61B; RFSA-61M; RFSTI-11B; RFDAC-71B, RFSC-61, RFSAI-61B

Load type	cos φ ≥ 0.95	M	M	AC5a without compensation	AC5a with compensation	HAL 230V			
Contact material AgSnO <sub>2</sub> , Contact 16 A	AC1 250 V / 16 A	AC2 250 V / 5 A	AC3 250 V / 3 A	230 V / 3 A (690 VA)	230 V / 3 A (690 VA) up to max input C=14uF	AC5b 1000 W	AC6a x	AC7b 250 V / 3 A	AC12 250 V / 10 A
Load type									
Contact material AgSnO <sub>2</sub> , Contact 16 A	AC13 x	AC14 250 V / 6 A	AC15 250 V / 6 A	DC1 24 V / 10 A	DC3 24 V / 3 A	DC5 24 V / 2 A	DC12 24 V / 6 A	DC13 24 V / 2 A	DC14 x

Multi function RFDA-73M/RGB, RFDEL-71B, RFDEL-71M, RFDSC-71, RFDAC-71B, RFDW-71

Light scene function 1

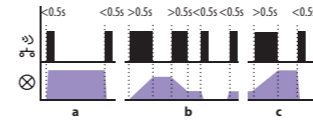

- a) By pressing the programmed button for less than 0.5 s, the light illuminates; it goes out by pressing again.
- b) By pressing the programmed button for more than 0.5 s, fluid brightness regulation will occur. After releasing the button, the brightness level is saved in the memory, and pressing the button shortly later will switch the light on/off to this intensity.
- c) It is possible to readjust the change in intensity at any time by a long press of the programmed button. The actuator remembers the adjusted value even after disconnecting from the power supply.

Light scene function 3

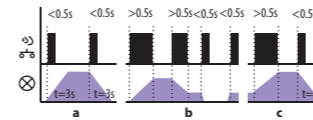

- a) By pressing the programmed button for less than 0.5 s, the light fluidly illuminates for a period of 3 s (at 100% brightness). By pressing the button shortly again, the light will continuously switch off for 3 seconds.
- b) By pressing the programmed button for more than 0.5 s, fluid brightness regulation will occur. After releasing the button, the brightness level is saved in the memory, and pressing the button shortly later will switch the light on/off to this intensity.
- c) It is possible to readjust the change in intensity at any time by a long press of the programmed button. The actuator remembers the adjusted value even after disconnecting from the power supply.

Function sunrise

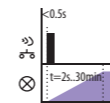

After pressing the programmed button, the light begins to illuminate in the programmed time interval in a range of 2 seconds to 30 minutes.

Function ON/OFF

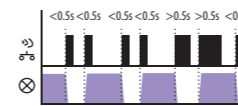

If the light is switched off, pressing the programmed button will switch it on. If the light is switched on, pressing the programmed button will switch it off.

Light scene function 2

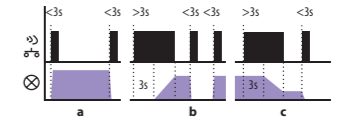

- a) By pressing the programmed button for less than 3 s, the light illuminates; it goes out by pressing again.
- b) In order to limit undesirable control of brightness, fluid brightness control occurs only by pressing a programmed button for over 3 s. After releasing the button, the brightness level is saved in the memory, and pressing the button shortly later will switch the light on/off to this intensity.
- c) It is possible to readjust the change in intensity at any time by pressing the programmed button for over 3 s. The actuator remembers the adjusted value even after disconnecting from the power supply.

Light scene function 4

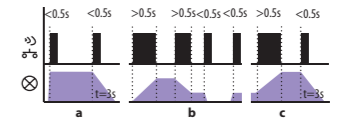

- a) By pressing the programmed button for less than 0.5 s, the light illuminates. By pressing the button shortly again, the light will continuously switch off for 3 seconds (at 100% brightness).
- b) By pressing the programmed button for more than 0.5 s, fluid brightness regulation will occur. After releasing the button, the brightness level is saved in the memory, and pressing the button shortly later will switch the light on/off to this intensity.
- c) It is possible to readjust the change in intensity at any time by a long press of the programmed button. The actuator remembers the adjusted value even after disconnecting from the power supply.

Function sunset

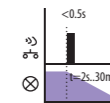

After pressing the programmed button, the light begins to dim in the programmed time interval in a range of 2 seconds to 30 minutes.

Function switch off

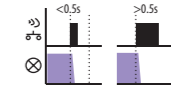

The dimmer output switches off by pressing the button.

Rating of the light source ELKO lighting on dimmers ELKO EP

	LED bulb		LED spot lights			LED panels		LED / RGB strip					
	DLB-E27-806-2K7	DLB-E27-806-5K	DLSL-GU10-350-3K	LSL-GU10-350-3K	L5L-GU10-350-5K	LP-6060-3K	LP-6060-6K	Dài LED 7.2W	Dài LED 14.4W	Dài LED 19.2W	Dài LED 28.8W	Dài RGB 7.2W	Dài RGB 14.4W
RFDSC-71	✓ 21	✓ 21	✓ 45	✓ 25	✓ -	-	-	-	-	-	-	-	-
RFDEL-71B	✓ 11	✓ 11	✓ 25	✓ 13	✓ 13	-	-	-	-	-	-	-	-
RFDA-73M/RGB	-	-	-	-	-	-	-	✓ 3x8m	✓ 3x4m	✓ 3x5m	✓ 3x4m	✓ 20m	✓ 10m
RFDAC-71B	-	-	-	-	-	✓ 50	✓ 50	-	-	-	-	-	-

WARNING!

May lead to different results based on the state of network cable length and other factors.

This table contains the results of tests that were conducted internally and therefore is ONLY for customers only informative. The products were tested in test laboratories ELKO EP, and therefore the company assumes no responsibility for any imitation test environment.

Inductive and capacitive loads must not be connected simultaneously!

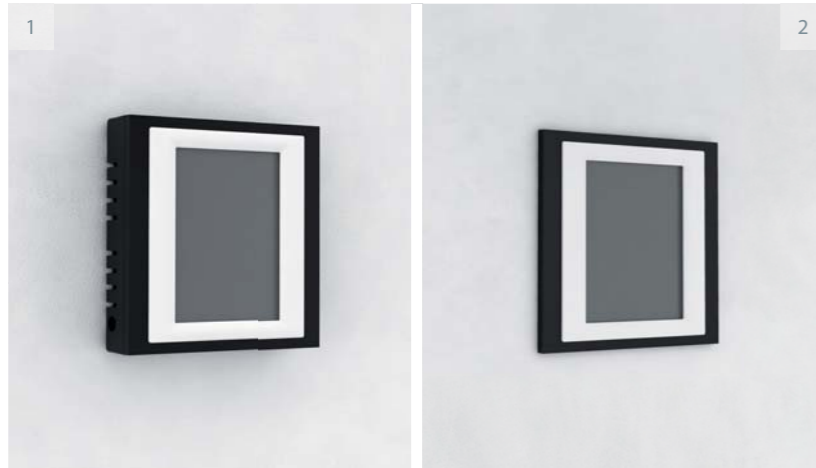
**1) Surface mounted**

Wall mounted or in an installation box with spacing of 65 mm.

RF Touch-W	RFTC-10/G
RFWB-20/G	RFTC-50/G
RFWB-40/G	RFTC-150/G

**2) Flush mounted**

RF Touch-B	RFPCR-31/G
RFSTI-11/G	RFGCR-31
RFTC-100/G	RFGCH-31
RFDW-71	

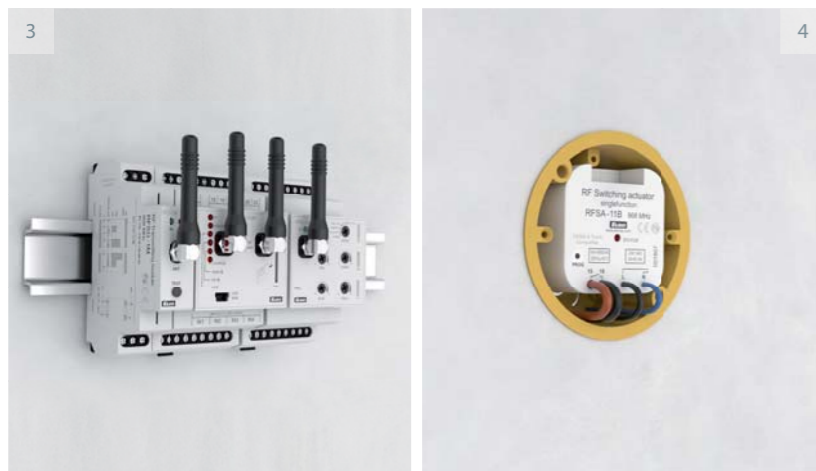
**3) DIN Rail mounted**

On DIN rail according to EN 60715.

RFSG-1M	RFDEL-71M
RFSGM-220M	RFS-61M
RFP-2M	RFS-66M
RFDA-73M/RGB	RFS-166M

**4) Mounted to or in the installation box**

RFIM-20B	RFSAI-62B
RFIM-40B	RFJA-12B
RFDAC-71B	RFJA-32B
RFDEL-71B	RFSF-1B
RFS-11B	RFSTI-11B
RFS-61B	RFTI-10B
RFS-62B	RFSAI-161B
RFSAI-61B	RFSTI-111B

**5) Mounted into the cover of appliance**

RFDAC-71B	RFSAI-61B
RFDEL-71B	RFJA-12B
RFS-11B	RFJA-32B
RFS-61B	RFSAI-161B
RFS-62B	RFSTI-111B

**6) Surface mounted**

RFSOU-1	RFSD-100
RFUS-61	RFMD-100
RFTM-1	RFWD-100
RFSF-1B	



The communication between the components is wireless at 868 - 916 MHz (according to country standards / regulations), using the unique RFIO and RFIO<sup>2</sup> protocols. Both are proprietary wireless protocols from ELKO EP, which have a completely unique structure. RFIO<sup>2</sup> is an extension of the RFIO protocol and allows users to use newly introduced features, such as unit signals (repeater), for selected features. This protocol is fully compatible with the previous version of the protocol (RFIO).

**Available frequency for individual territories:**

**866 MHz** India

**868 MHz** EU, UA, RU, Middle east

**916 MHz** North / South America, Australia, New Zealand

**Benefits of RFIO:**

- communication is low-energy and reliably transfers small data packets.
- fees or licenses are not required
- no overlapping of communication space with unaddressed commands.
- frequency used does not interfere with Wi-Fi / Bluetooth devices.
- setting communication between components is not conditional on working with a computer or system.

**Benefits of RFIO<sup>2</sup>:**

- products labeled as "RFIO<sup>2</sup>" will allow newly set selected components such as unit signals (repeaters).
- for components, you can easily update FW using the RFAF / USB service device.
- enables communication with RFMD-100, RFWD-100 and RFSD-100 / RFSD-101
- data transfer between wireless components takes place in such a way that other receivers within range can help transfer the information (packet) to a remote receiver that is out of reach. It is possible to cover large-scale objects (real estate) and also increase the reliability of transmission in more demanding buildings.
- Backward compatibility with RFIO elements is retained.

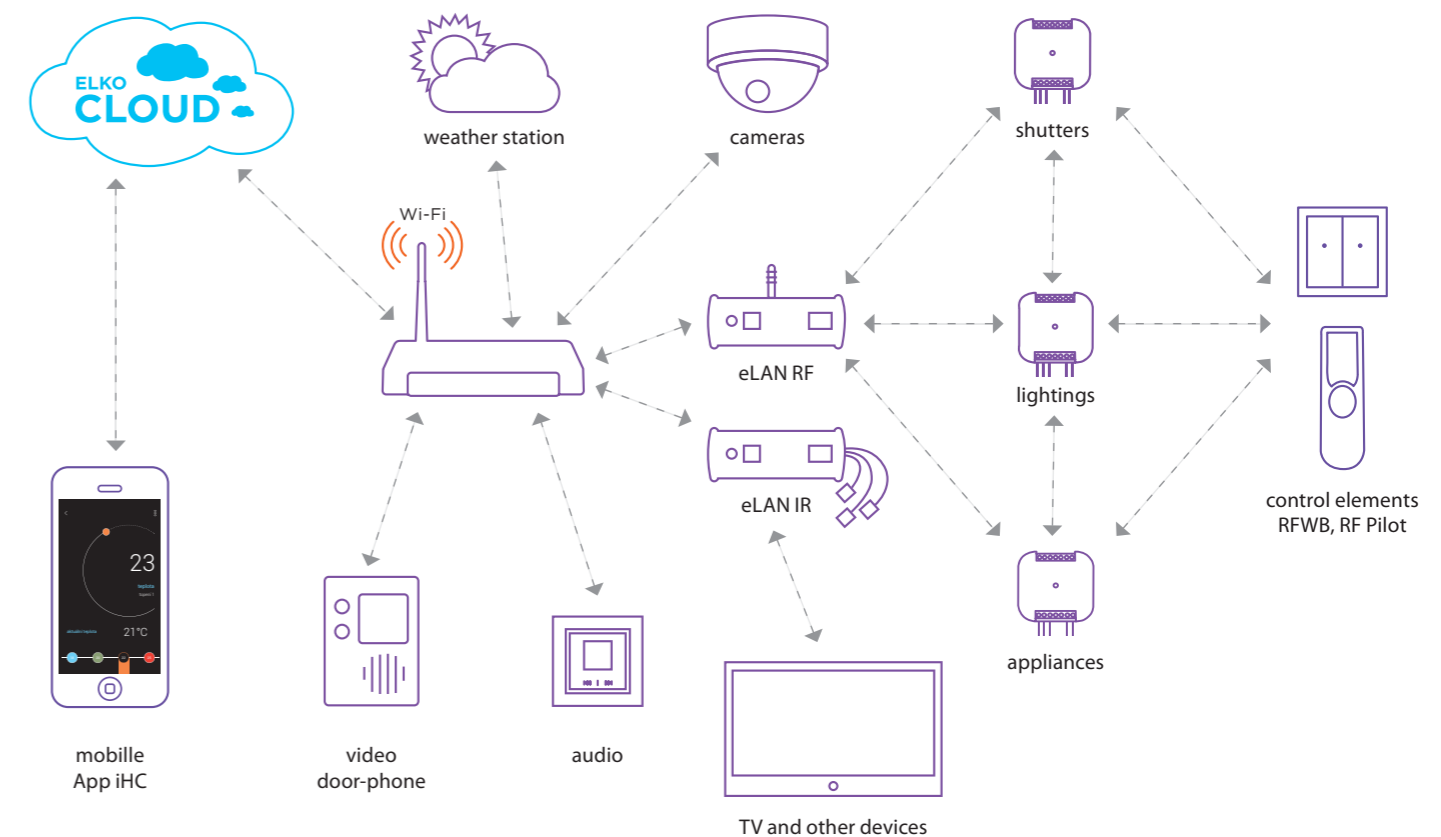

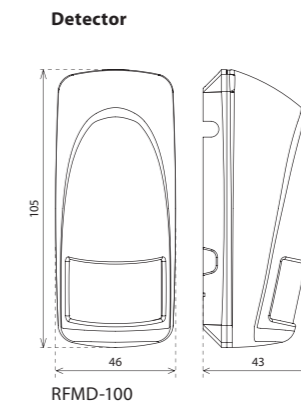
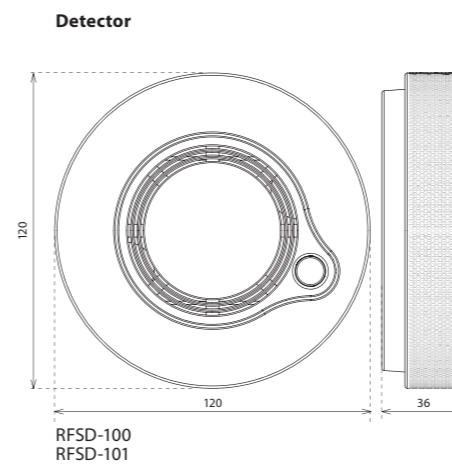
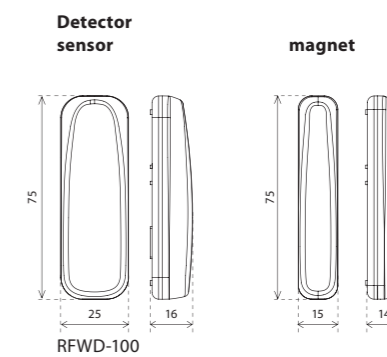
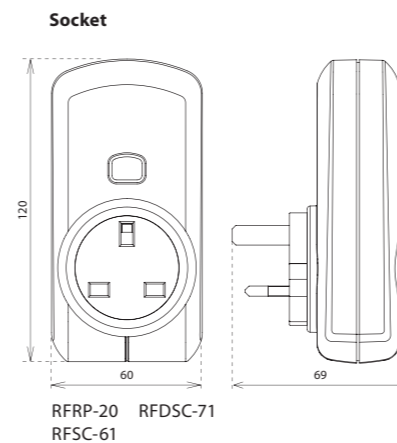
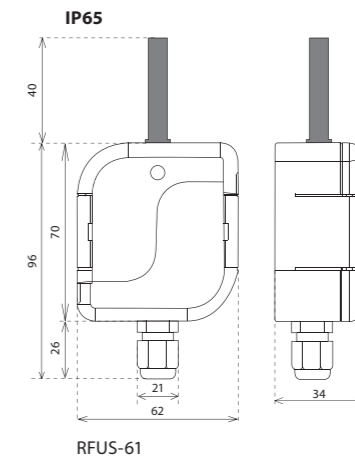
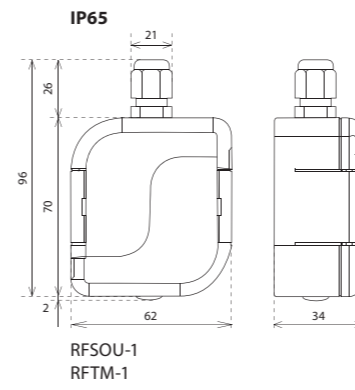
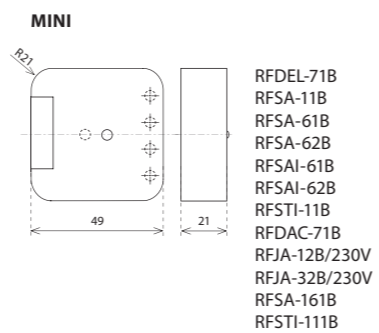
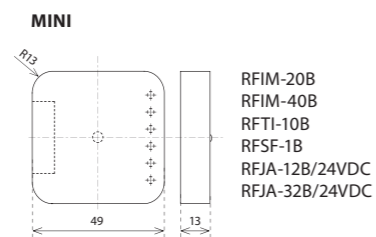
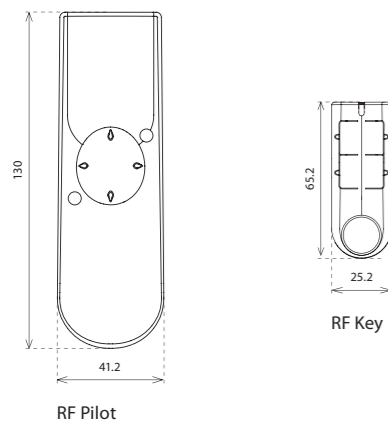
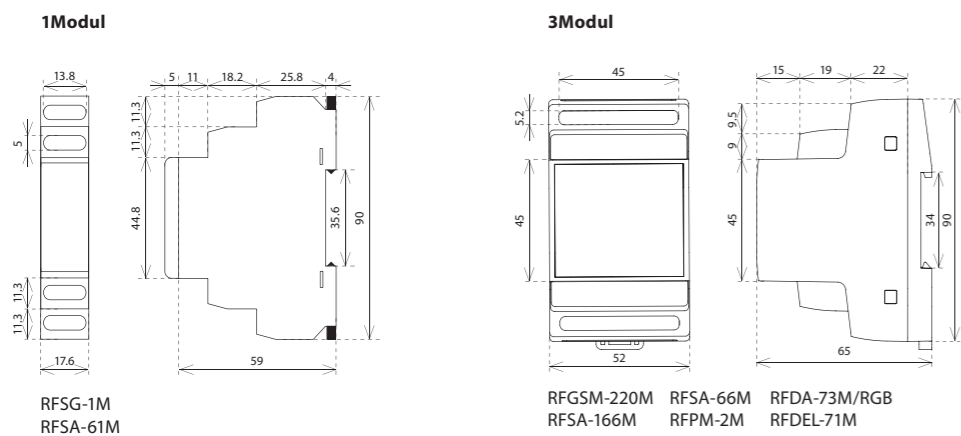
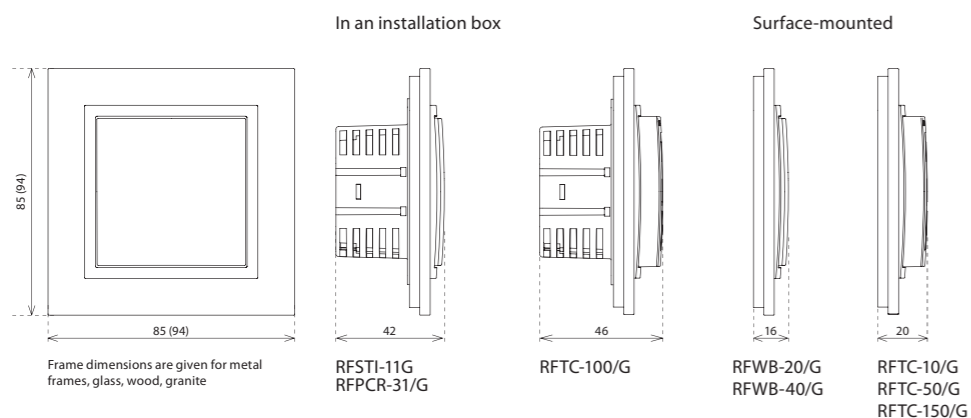
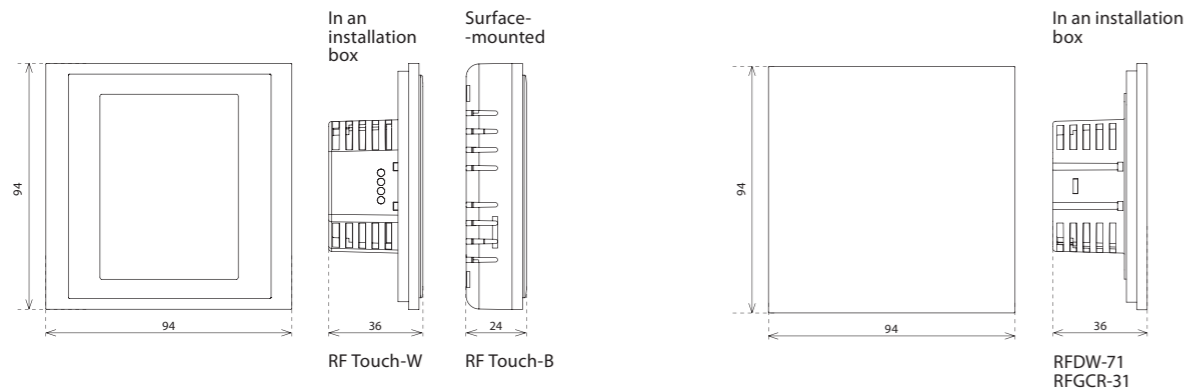



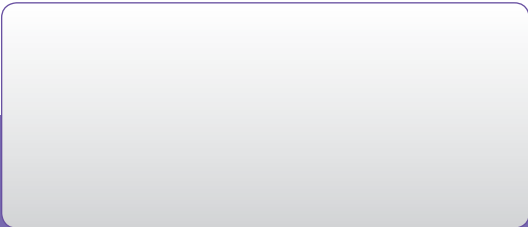
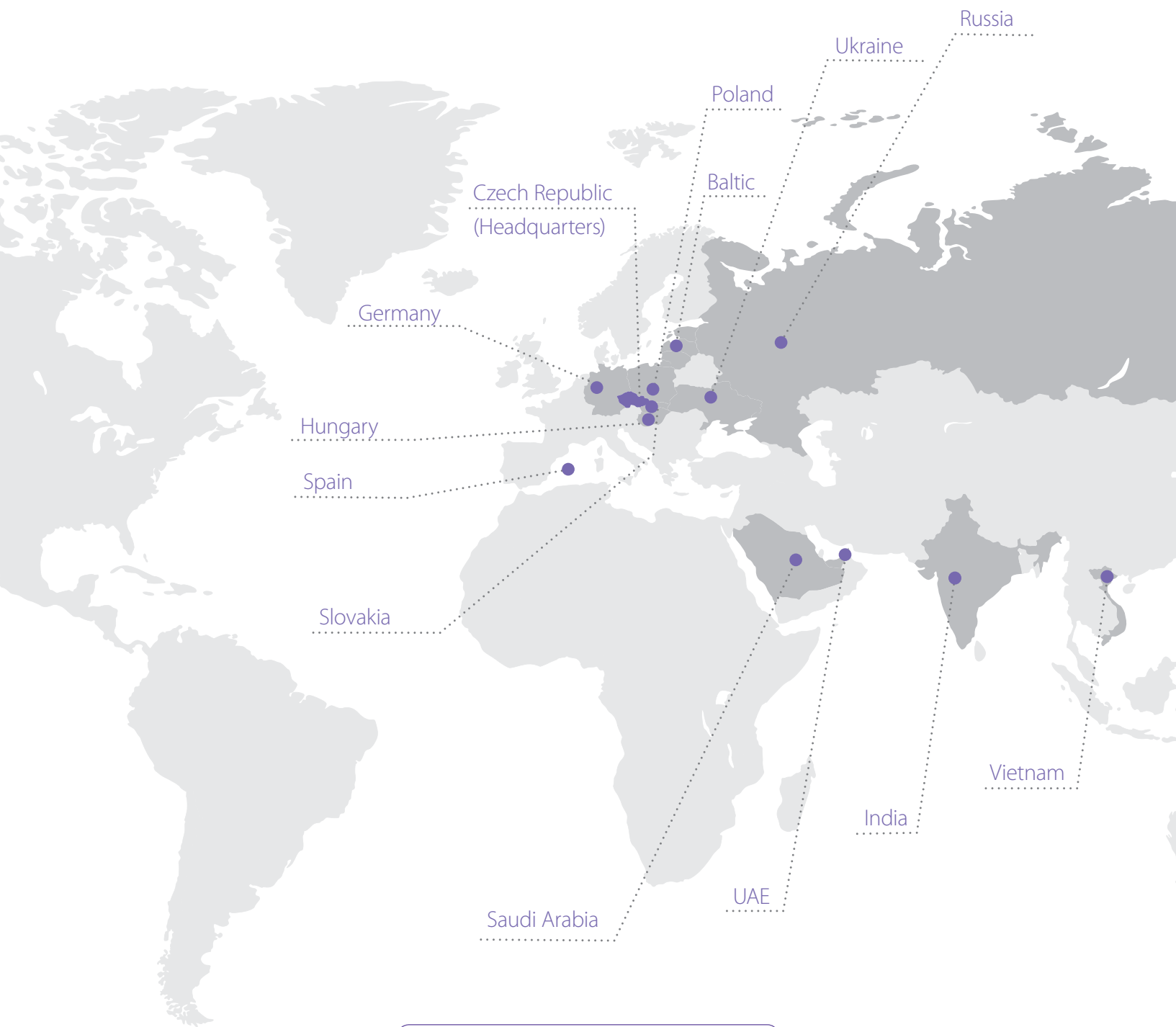

**ELKO EP, s.r.o.**

Palackeho 493 | 769 01 Holesov, Vsetuly | Czech Republic  
phone: +420 573 514 221 | fax: +420 573 514 227 | [elko@elkoep.com](mailto:elko@elkoep.com) | [www.elkoep.com](http://www.elkoep.com)

Published: 01/2019 | Modifications or amendments reserved | © Copyright ELKO EP, s.r.o. | 1st edition